



2024



Alüminyum Profil Katalođu
Aluminium Profile Catalogue

ALÜMİNYUM PROFİL GRUBU

Aluminium Profile Group



ISO 9001 | ISO 14001 | OHSAS 18001

GOLD SERİ PLİSE SİNEKLİK / GOLD SERIES PLAİT FLY SCREEN

304

0,318 kg/m

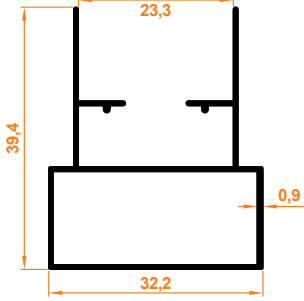

Gold Kasa Profil
Gold Case Profile

305

0,330 kg/m

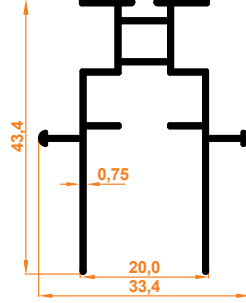

Gold Kanat Profil
Gold Wing Profile

STAR SERİ PLİSE SİNEKLİK / STAR SERIES PLAİT FLY SCREEN

302

0,272 kg/m

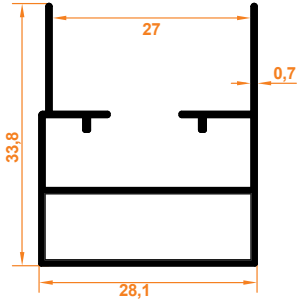

Star Kasa Profil
Star Case Profile

301

0,303 kg/m

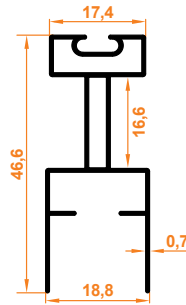

Star Kanat Profil
Star Wing Profile

JUNIOR SERİ PLİSE SİNEKLİK / JUNIOR SERIES PLAİT FLY SCREEN

306

0,243 kg/m

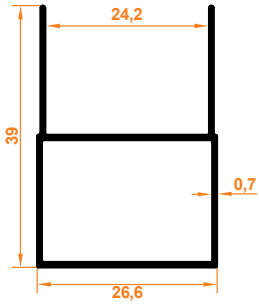

Junior Kasa Profil
Junior Case Profile

307

0,304 kg/m

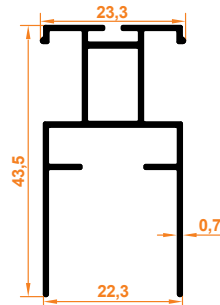

Junior Kanat Profil
Junior Wing Profile

345

0,162 kg/m

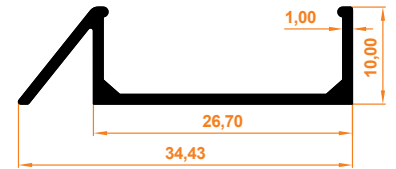

Junior Eşiksiz Kasa Profil
Junior Case Profile without Threshold

SLIM SERİ PLİSE SİNEKLİK / SLIM SERIES PLAİT FLY SCREEN

300 0,218 kg/m

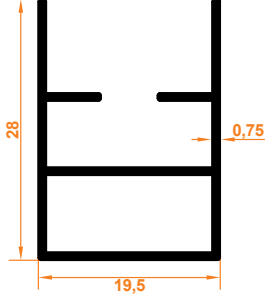

Slim Kasa Profili
Slim Case Profile

301 0,303 kg/m

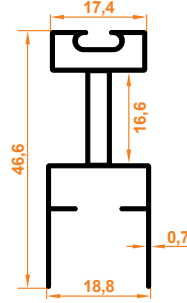

Slim Kanat Profili
Slim Wing Profile

331 0,168 kg/m



Slim Eşiksiz Profili
Slim Profile without Threshold

NOBEL SERİ PLİSE SİNEKLİK / NOBEL SERIES PLAİT FLY SCREEN

335 0,345 kg/m

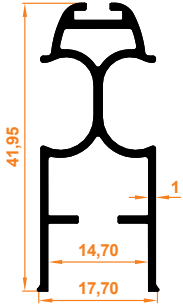

Nobel Kanat Profili
Nobel Wing Profile

336 0,148 kg/m

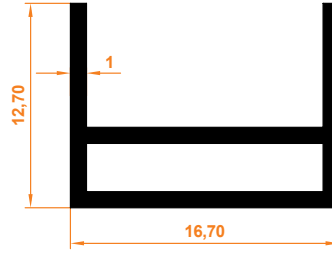

Nobel Eşiksiz Kasa Profili
Nobel Case Profile without Threshold

338 0,250 kg/m

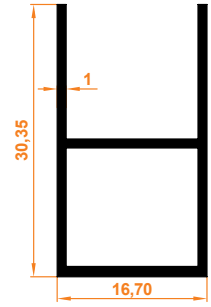

Nobel Kasa Profili
Nobel Case Profile

SÜPER SERİ PLİSE SİNEKLİK / SUPER SERIES PLAİT FLY SCREEN

316 0,248 kg/m

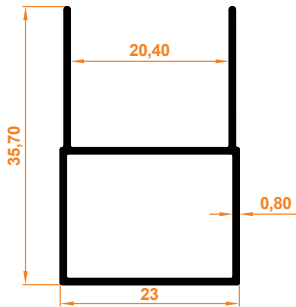

Süper Seri Kasa Profili
Super Case Profile

320 0,303 kg/m

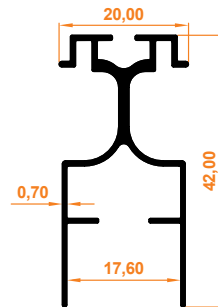

Süper Seri Kanat Profili
Super Wing Profile

325 0,469 kg/m

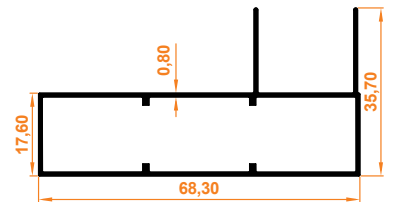

Süper Büyük Kasa Profili
Super Big Case Profile

NOBEL SERİ İÇTEN MONTAJLI PLİSE SİNEKLİK / NOBEL SERIES INTERNAL MOUNTED PLAIT FLY SCREEN

337

0,338 kg/m

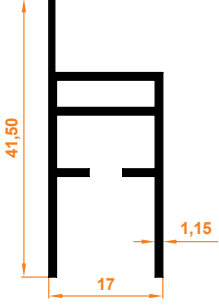

Nobel İçten Montajlı Kasa Profili
Nobel Internal Mounted Case Profile

335

0,345 kg/m

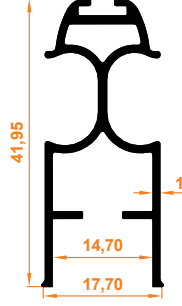

Nobel Kanat Profili
Nobel Wing Profile

SLIM SERİ İÇTEN MONTAJLI PLİSE SİNEKLİK / SLIM SERIES INTERNAL MOUNTED PLAIT FLY SCREEN

317

0,272 kg/m

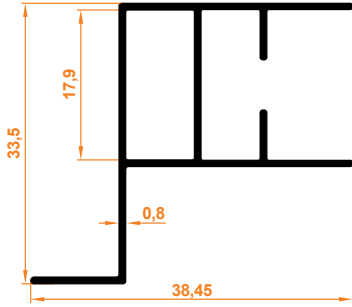

Kasa Profil
Case Profile

301

0,303 kg/m

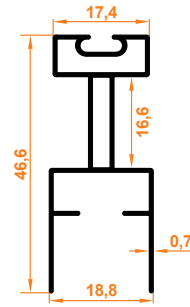

Kanat Profil
Wing Profile

İÇTEN MONTAJLI SABİT SİNEKLİK / INTERNAL MOUNTED FIXED FLY SCREEN

405

0,256 kg/m

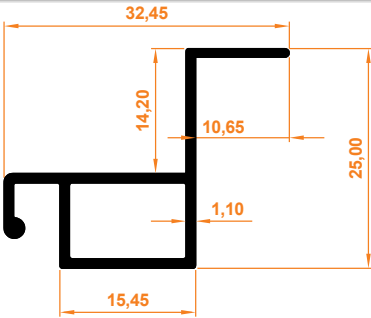

Kasa Profili
Case Profile

AYKİM SERİ SİNEKLİK / AYKİM SERIES FLY SCREEN

309

0,374 kg/m

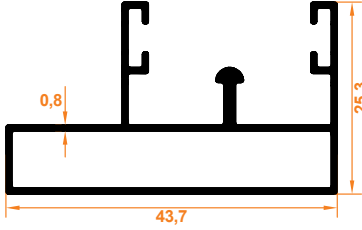

310

0,315 kg/m

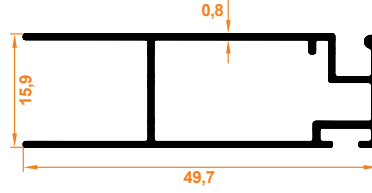

Aykim Kasa Profil
Aykim Case Profile

Aykim Hareketli Profil
Aykim Sliding Profile

PLATİN SERİ SİNEKLİK / PLATİN SERIES FLY SCREEN

321

0,352 kg/m

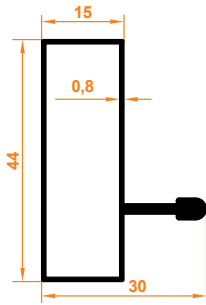

322

0,455 kg/m

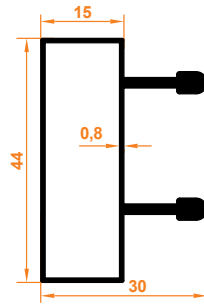

323

0,506 kg/m

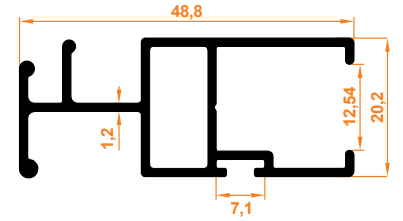

Platin Tekli Kasa Profil
Platin Single Case Profile

Platin Çiftli Kasa Profil
Platin Double Case Profile

Platin Kanat Profil
Platin Wing Profile

DÜZ SİNEKLİK PROFİL GRUBU
Flat Fly Screen Profile Group

400

0,105 kg/m

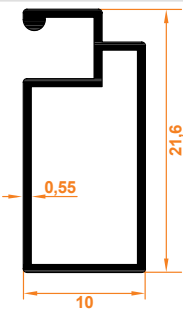

401

0,142 kg/m

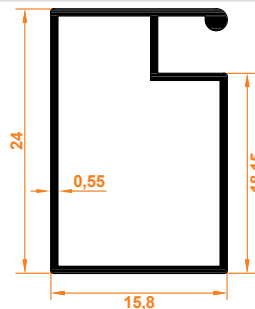

402

0,250 kg/m

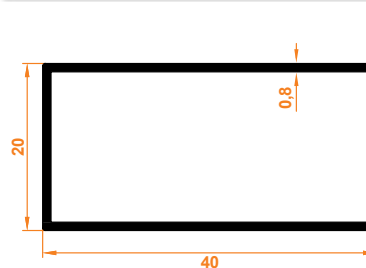

311

0,304 kg/m

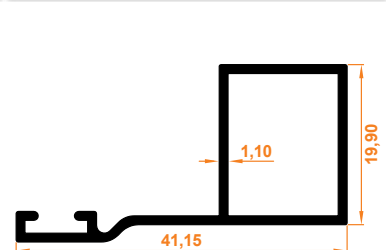

10x20 Sineklik
10x20 Fly Screen

17x25 Sineklik
17x25 Fly Screen

20x40 Sineklik
20x40 Fly Screen

İçe Açılır Fitilli Sineklik Profili
Inward Foldable Flyscreen Profile

407

0,342 kg/m

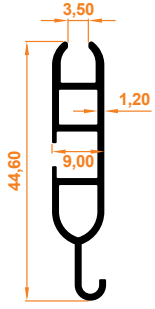

Stor Kanat Profil
Stor Wing Profile

408

0,286 kg/m

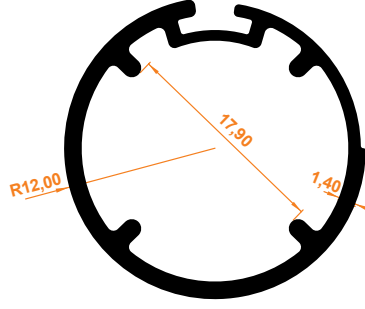

Stor Boru Profil
Stor Pipe Profile

409

0,526 kg/m

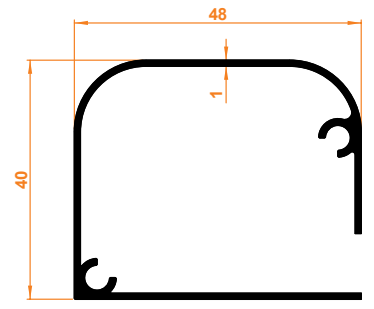

Stor Kasa Profil
Stor Case Profile

410

0,413 kg/m

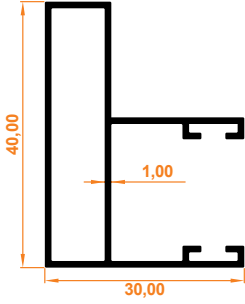

Stor Yan Kasa Profil
Stor Side Case Profile

411

0,318 kg/m

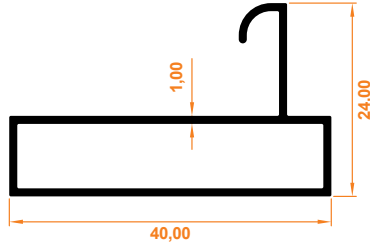

Stor Alt Kasa Profil
Stor Bottom Case Profile

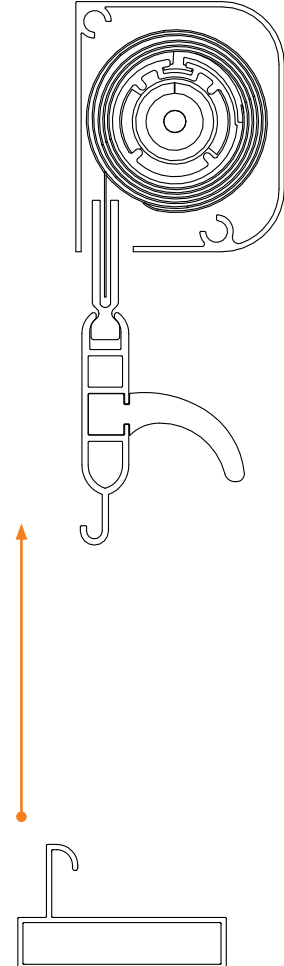
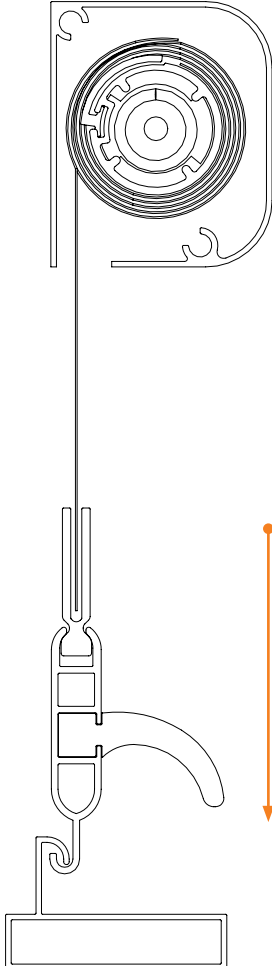

1

0,247 kg/m

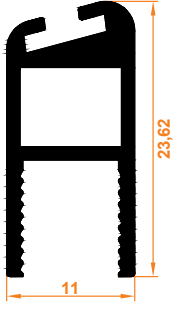

Büyük D Fitol
Big D Wick

2

0,167 kg/m

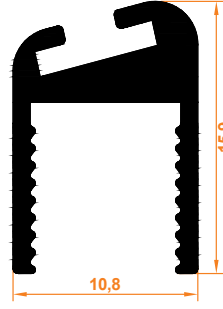

Küçük D Fitol
Small D Wick

3

0,116 kg/m

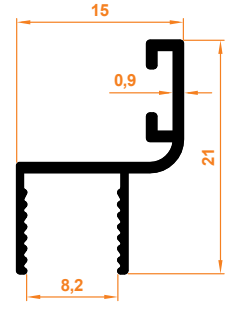

Küçük h Fitol
Small h Wick

4

0,150 kg/m

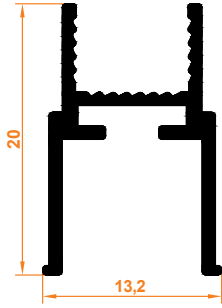

Orta H Fitol
Middle H Wick

5

0,214 kg/m

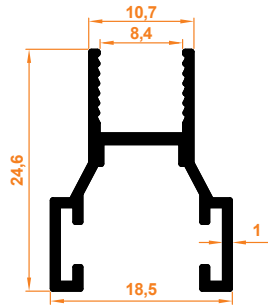

Büyük H Fitol
Big H Wick

6

0,276 kg/m

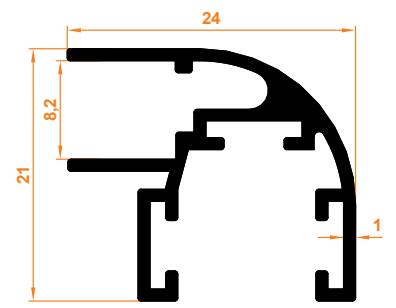

Köşe Dönüş Fitol
Corner Return Wick

8 mm CAM BALKON PROFİL GRUBU

8 mm Glass Balcony Profile Group

101

0,078 kg/m

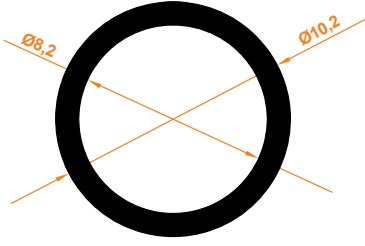

10'lü Stoplama
10 Stopping Profile

104

0,717 kg/m

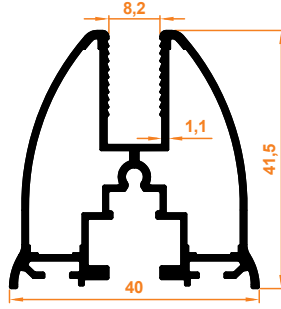

Gold Baza
Gold Base

105

0,730 kg/m

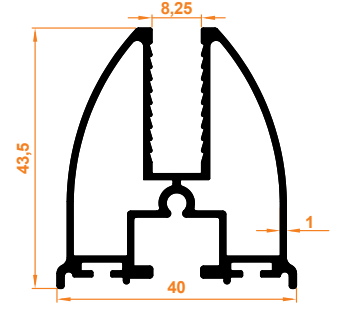

Firtina Baza
Firtina Base

109

1,355 kg/m

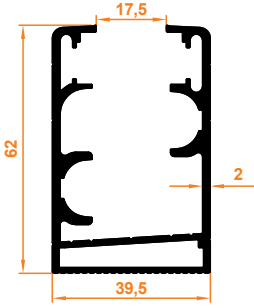

Düz Kasa Profil
Flat Case Profile

110

1,396 kg/m

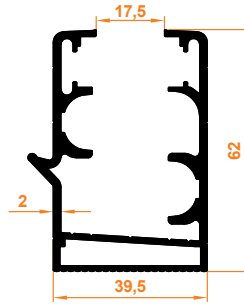

Oluklu Kasa Profil
Corrugated Case Profile

100

0,441 kg/m

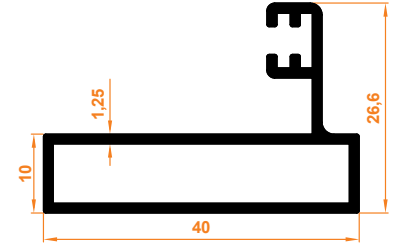

Dar Yan Dikme
Thin Side Column

106

1,611 kg/m

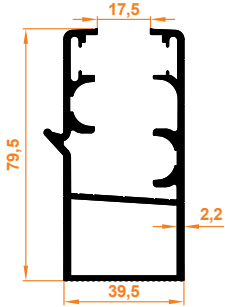

Oluklu Büyük Kasa Profil
Corrugated Big Case Profile

107

1,570 kg/m

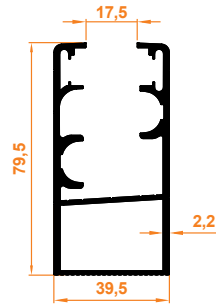

Büyük Düz Kasa Profil
Big Flat Case Profile

108

0,457 kg/m

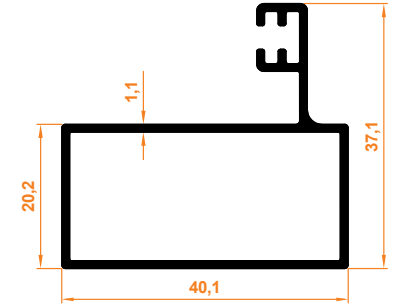

Geniş Yan Dikme
Thick Side Column Profile

111

1,062 kg/m

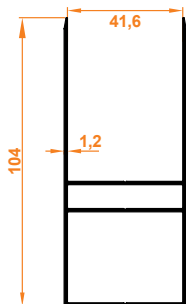

Stor Profil
Stor Profile

135

0,517 kg/m

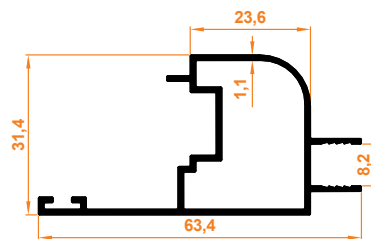

8 mm İspanyolet Profil
8 mm Espagnolette Profile

136

0,343 kg/m

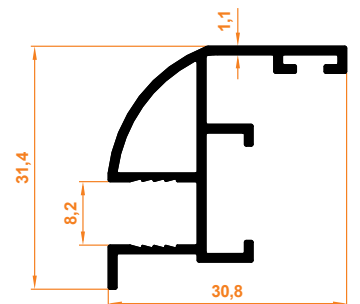

8 mm İspanyolet Profil Karşılığı
8 mm Espagnolette Combination Profile

800

0,618 kg/m

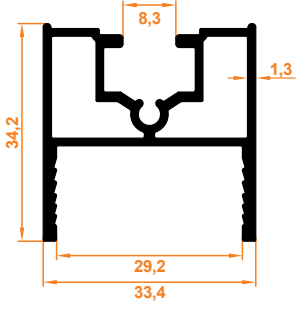

Baza Profil
Base Profile

801

0,321 kg/m

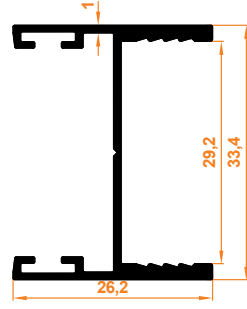

Düz Kapak Profil
Flat Cover Profile

802

0,327 kg/m

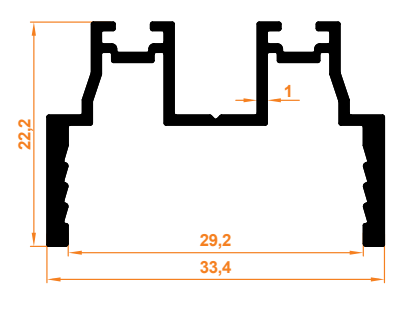

Düz Kapak Mentеше Profil
Flat Cover with Hinge Profile

803

0,445 kg/m

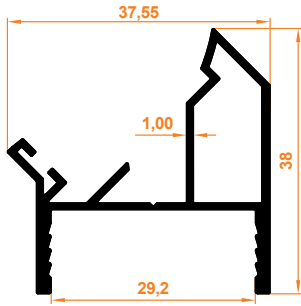

45° Dönüş Profil
45° Return Profile

804

0,378 kg/m

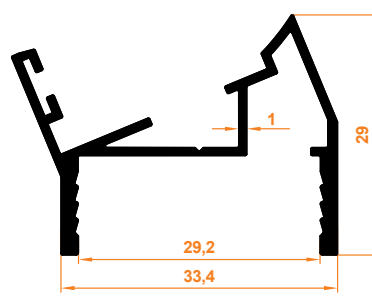

22,5° Dönüş Profil
22,5° Return Profile

805

0,366 kg/m

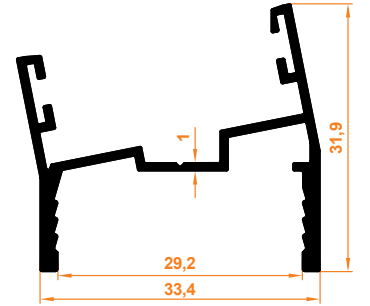

11° Dönüş Profil
11° Return Profile

806

0,475 kg/m

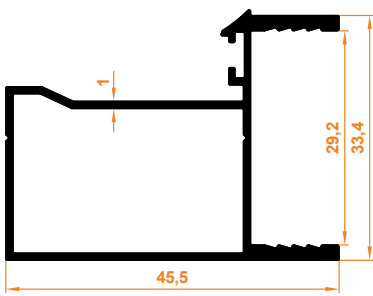

90° Dönüş Profil
90° Return Profile

807

0,346 kg/m

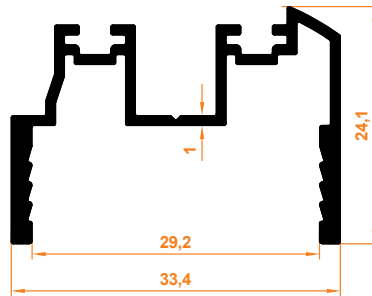

Açılı Dönüş Mentеше Profil
PopUp Return Hinge Profile

808

0,369 kg/m

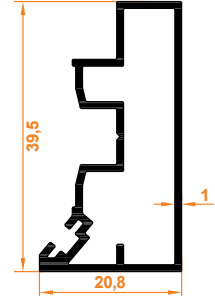

Yan Dikme Profil
Side Column Profile

809

0,328 kg/m

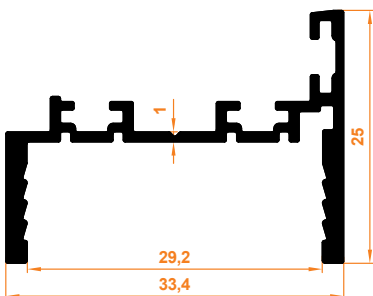

Sabit Cam Mentеше Profil
Stable Glass Hinge Profile

810

0,355 kg/m

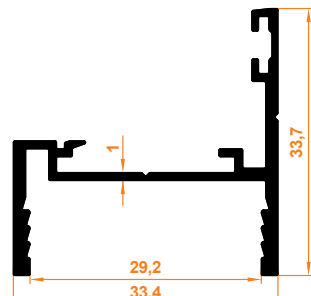

Sabit Cam Kilit Profil
Stable Glass Lock Profile

811

0,342 kg/m

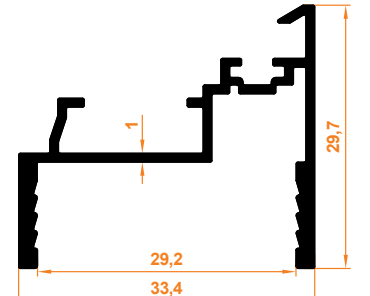

Sabit Cam Kilit Karşılığı Profil
Stable Glass Lock Prevention Profile

819

1,344 kg/m

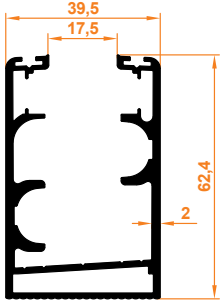

Düz Kasa Üstten Fitilli Profil
Flat Case Top Wicked Profile

820

1,389 kg/m

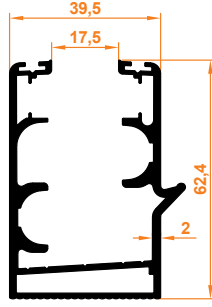

Oluklu Kasa Üstten Fitilli Profil
Corrugated Case Top Wicked Profile

822

0,378 kg/m

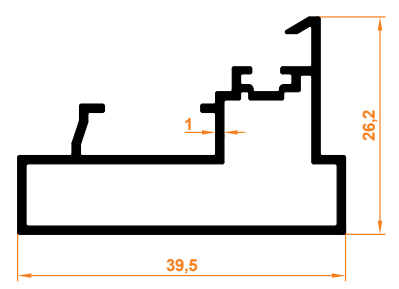

Açılır Dikme Profil
PopUp Column Profile

816

1,577 kg/m

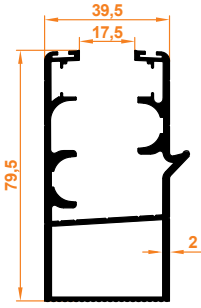

Üstten Fitilli Büyük Oluklu Kasa
Large Corrugated Case with Top Wick

817

1,532 kg/m

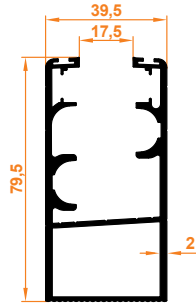

Üstten Fitilli Büyük Düz Kasa
Large Flat Case with Wed from Top

815

0,100 kg/m

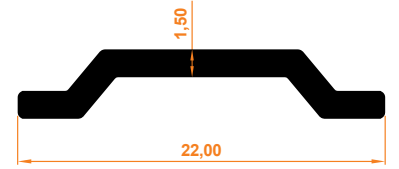

Tij Profil
Espagnolette Profile

823

0,459 kg/m

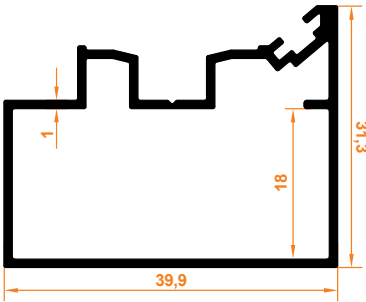

Geniş Yan Dikme
Wide Side Column

824

0,583 kg/m

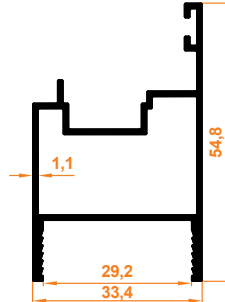

Sabit Cam İspanyolet Profil
Fixed Glass Espagnolette Profile

825

0,356 kg/m

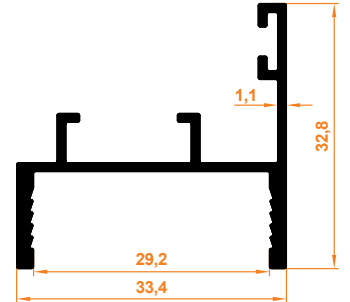

Sabit Cam İspanyolet Karşılık Profil
Fixed Glass Espagnolette Handle Provision Profile

210

0,643 kg/m

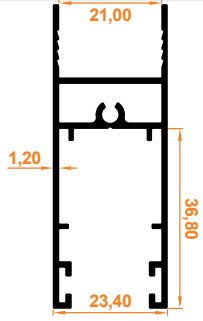

Sürme Baza Profil
Sliding Base Profile

215

0,908 kg/m

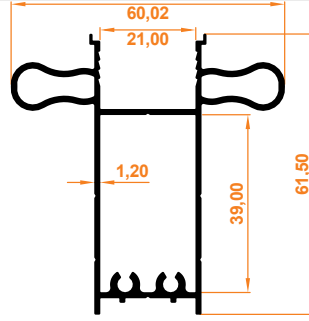

Çekme Kol Profil
Pull Handle Profile

212

0,423 kg/m

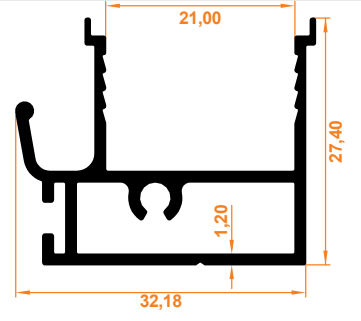

Kenet Profil
Clamp Profile

211

0,301 kg/m

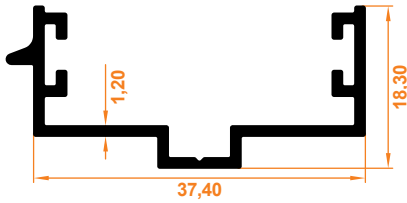

Birleştirme Karşılık Profil
Combination Provisions Profile

213

0,974 kg/m

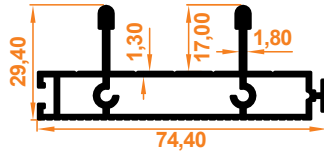

İkili Eşikli Alt Kasa Profil
Double Threshold Lower Case Profile

222

1,333 kg/m

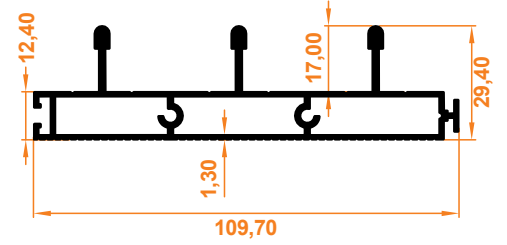

Üçlü Eşikli Alt Kasa Profil
Triple Threshold Lower Case Profile

220

0,867 kg/m

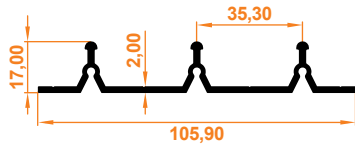

Üçlü Eşiksiz Alt Kasa Profil
Triple Bottom Case Profile without Threshold

229

1,120 kg/m

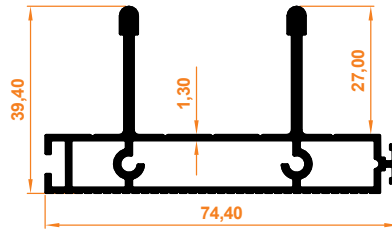

İkili Üst Kasa Profil
Double Upper Case Profile

230

1,552 kg/m

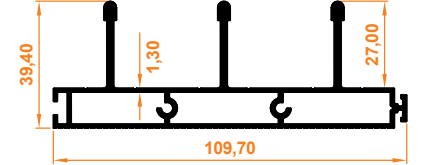

İkili Üçlü Kasa Profil
Triple Upper Case Profile

221

1,156 kg/m

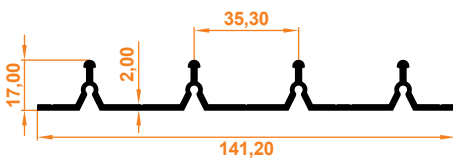

Dörtlü Eşiksiz Alt Kasa Profil
Quadruple Bottom Case Profile without Threshold

214

0,587 kg/m

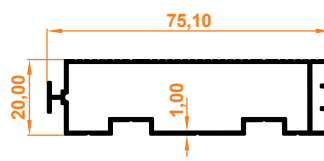

İkili Yan Kasa Profil
Double Side Case Profile

223

0,792 kg/m

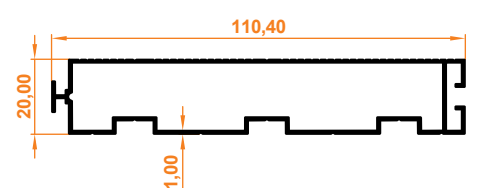

Üçlü Yan Kasa Profil
Triple Side Case Profile

219

0,219 kg/m

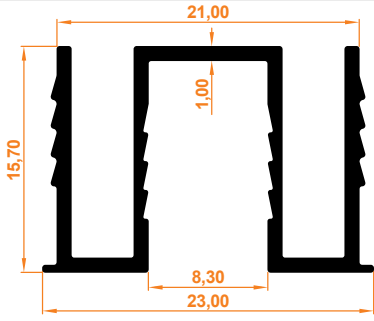

8 mm Cam Adaptörü
8mm Glass Adapter

226

0,071 kg/m

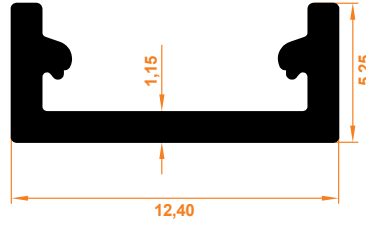

Kapatma Profil
Closing Profile

227

0,957 kg/m

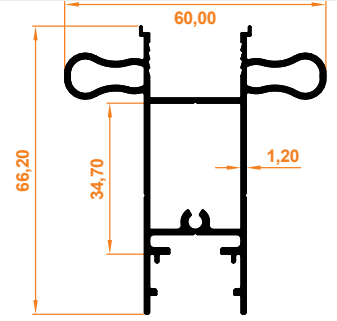

İspanyolet Çekme Kol Profili
Espagnolette Pull Handle Profile

228

0,156 kg/m

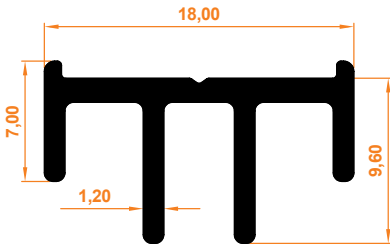

İspanyolet Karşılık Profili
Espagnolette Provision Profile

Sürme Sistem Çalışma Mekanizması

Sliding System Operating Mechanism

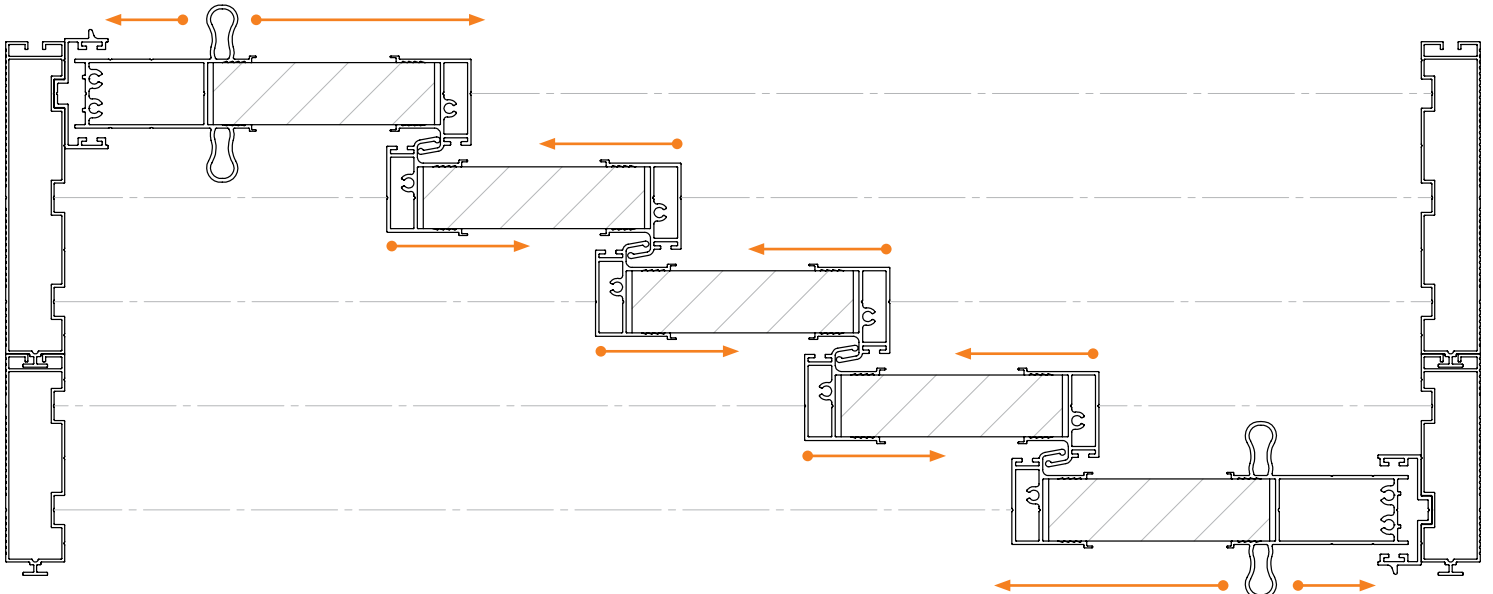

Sürme Sistem Çalışma Mekanizması

Sliding System Operating Mechanism

Eşikli Sistem

System with Treshold

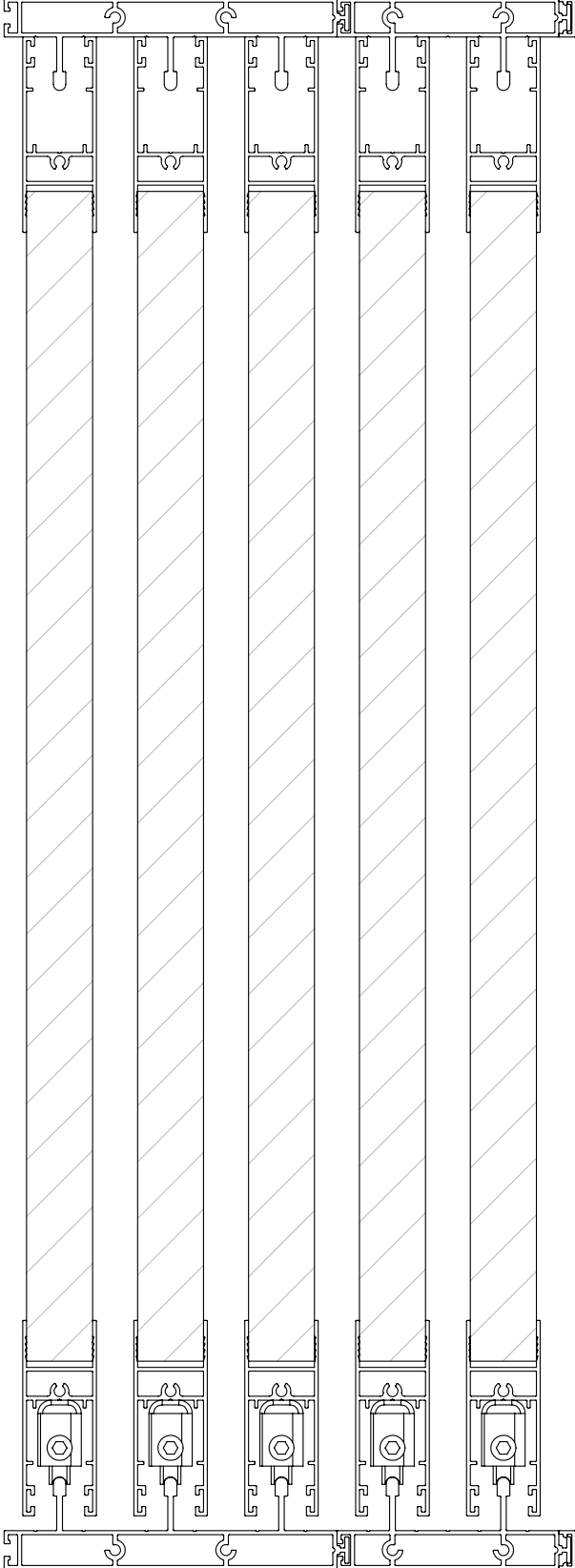

Eşiksiz Sistem

System without Treshold

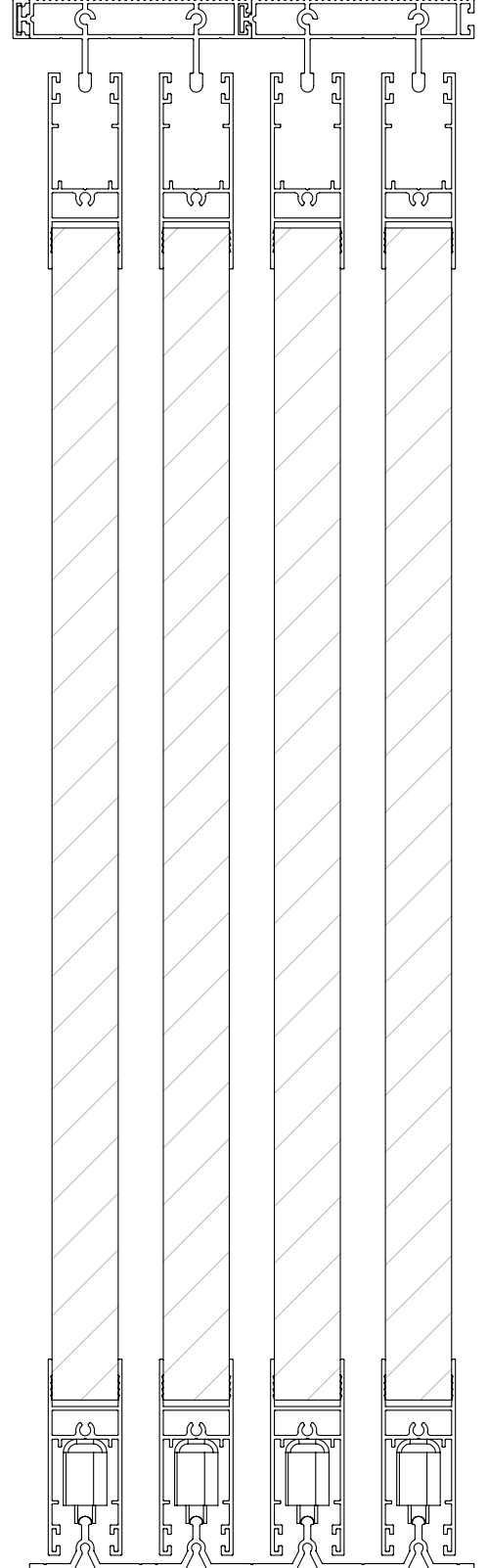

140

0,563 kg/m

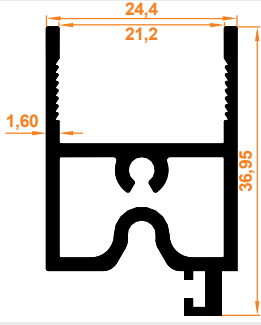

Sabit Panel Açılır Alt Baza Profil
Fixed Panel Pop-up Base Profile

164

0,842 kg/m

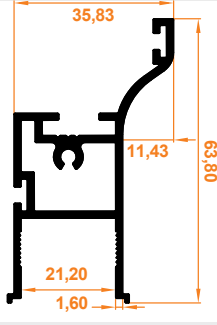

Sabit Panel Yan Dikme Profil
Fixed Panel Side Column Profile

142

0,750 kg/m

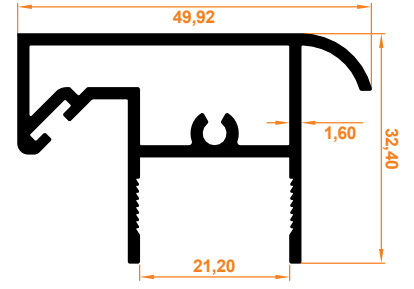

Sabit Panel Üst Baza Profil
Fixed Panel Top Base Profile

167

1,144 kg/m

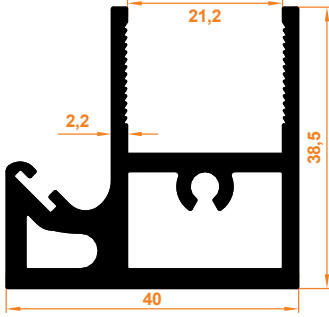

Kenet Baza Profil
Clamp Base Profile

144

0,434 kg/m

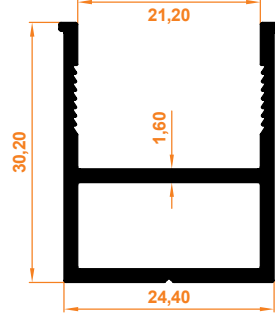

Hareketli Panel Yan Dikme Profil
Movable Panel Side Column Profile

145

0,579 kg/m

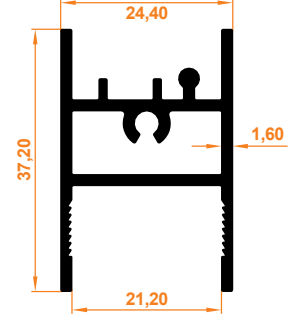

Küpeşte Baza Profil
Handrail Base Profile

146

0,741 kg/m

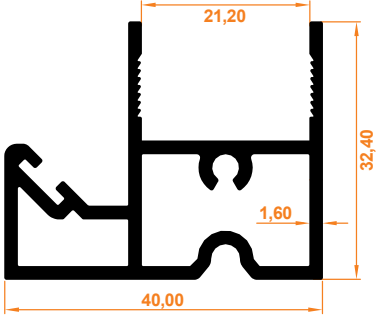

Hareketli Panel Açılır Alt Baza Profil
Movable Panel Pop-up Lower Base Profile

161

0,482 kg/m

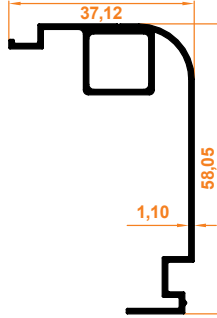

Ray Kapatma "T" Profil
Rail Closure "T" Profile

160

1,057 kg/m

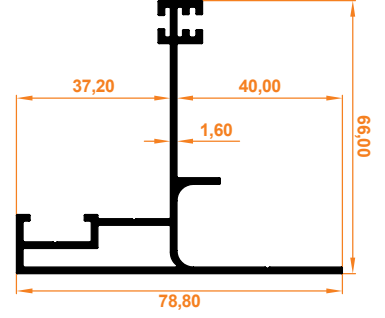

Yan Ray "T" Profil
Side Rail "T" Profile

166

0,144 kg/m



Açılımlı için Ray Kapatma 'L' Profil
Rail Closure 'L' Profile for Opening

162

0,703 kg/m

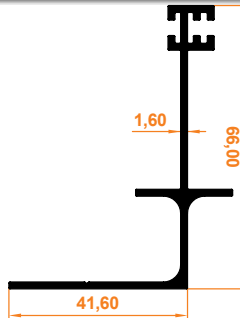

Yan Ray "L" Profil
Side Rail "L" Profile

GYT 28

2,110 kg/m

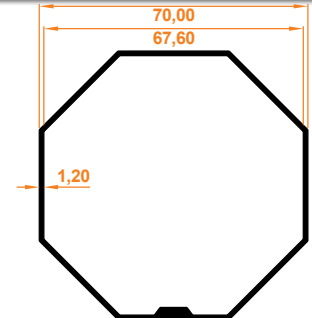

Sac Tambur Borusu
Sheet Drum Pipe

152

1,563 kg/m

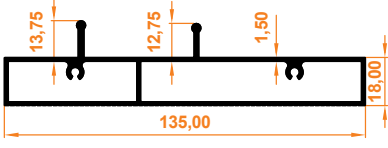

Alt Kasa
Guillotine Lower Case Profile

156

3,449 kg/m

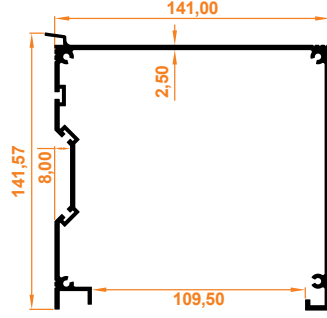

Üst Kasa Profil
Top Case Profile

153

0,864 kg/m



Üst Kasa Kapak Profil
Top Case Cover Profile

155

1,669 kg/m

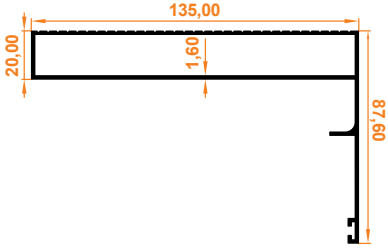

Yan Kasa Profil
Side Case Profile

154

0,759 kg/m

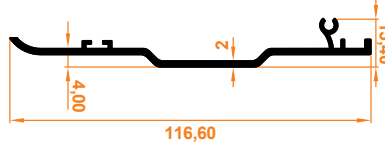

Küşte Profil
Handrail Profile

165

0,644 kg/m



Yan Kasa Kertme Profil
Side Case Notched Profile

158

0,510 kg/m

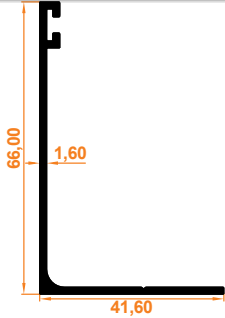

Açılımsız Tek Fitol Yan Ray L Kasa Profil
Single Weatherstrips Without Opening Side L Case Profile

159

0,660 kg/m

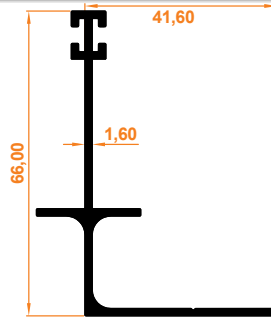

Açılımsız Çift Fitol Yan Ray L Kasa Profil
Double Weatherstrips Without Opening Side L Case Profile

219

0,219 kg/m

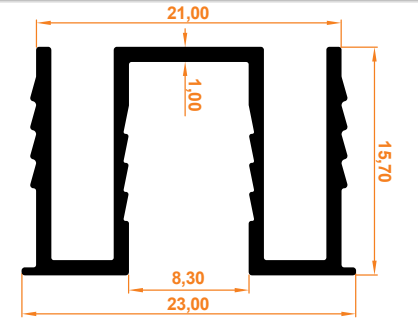

8 mm Cam Adaptörü
8mm Glass Adapter

149

0,162 kg/m

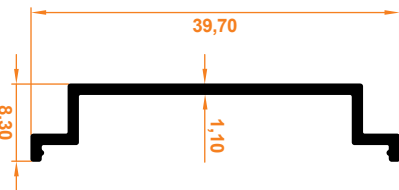

Açılımsız için Ray Kapatma 'L' Profil
Rail Closure 'L' Profile for Non-Opening

Giyotin Cam Balkon Çalışma Sistemi

Guillotine Glass Balcony Working System

1. Kademe - Level 1

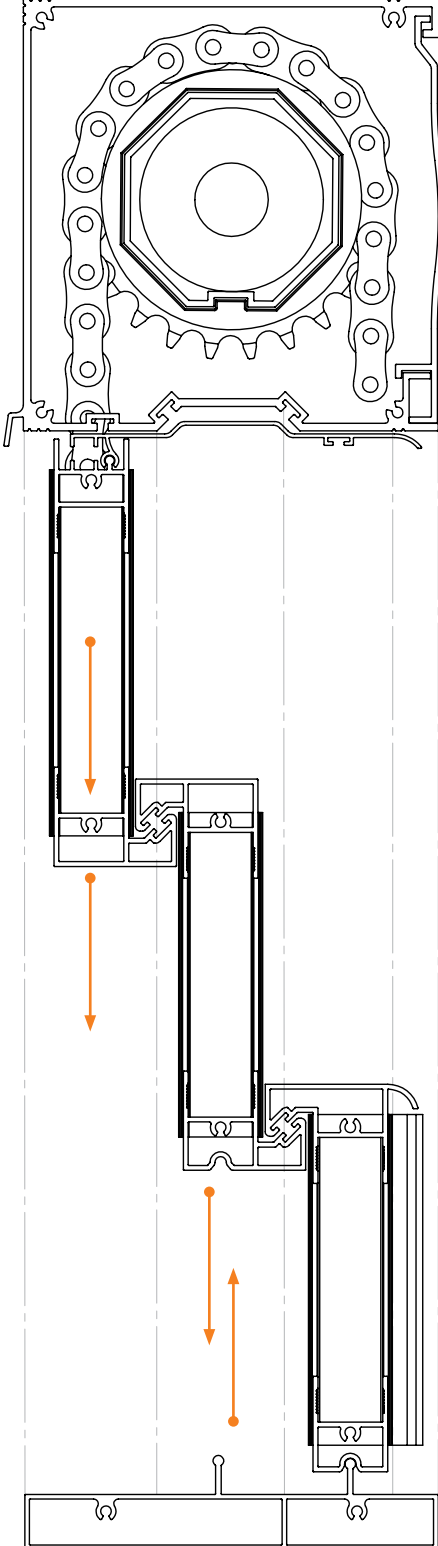

2. Kademe - Level 2

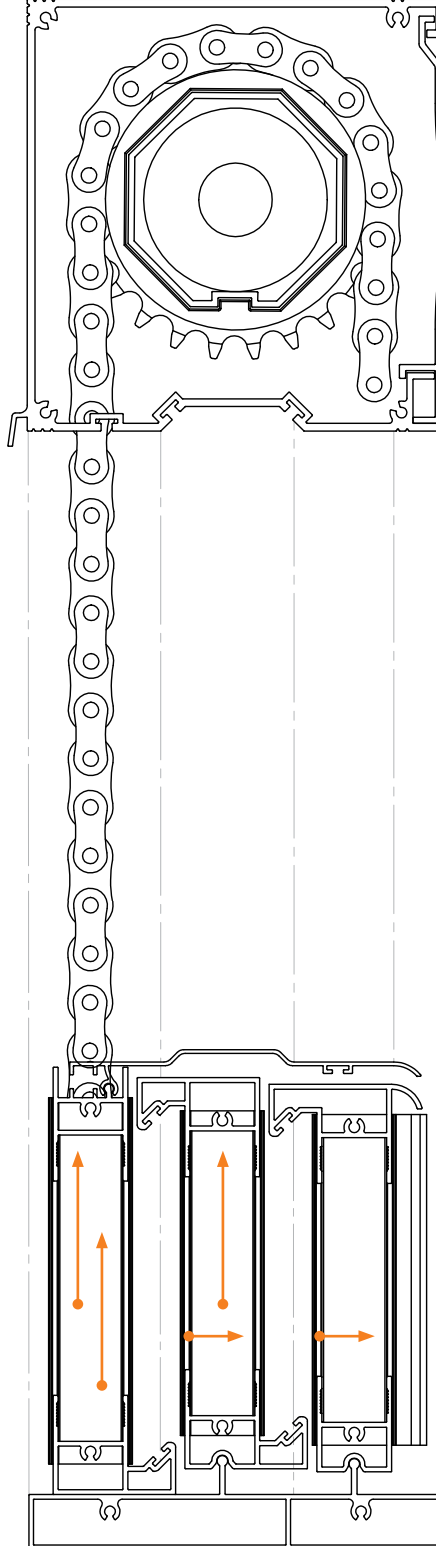

3. Kademe - Level 3

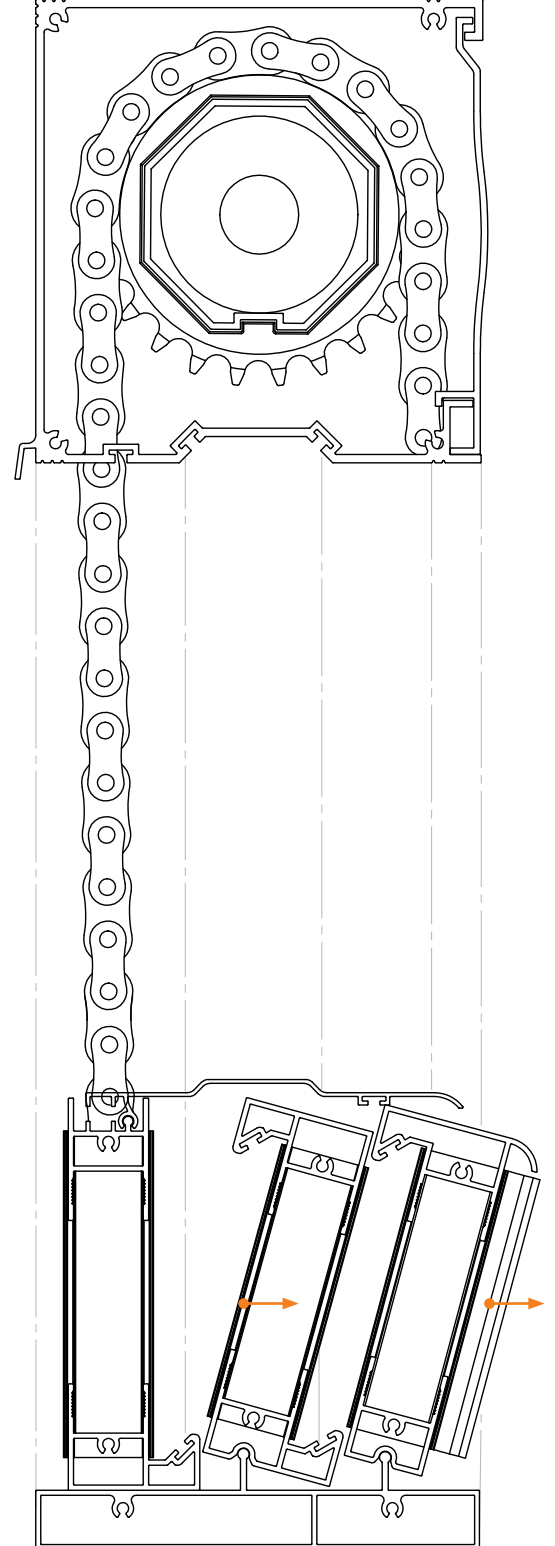

417

0,467 kg/m

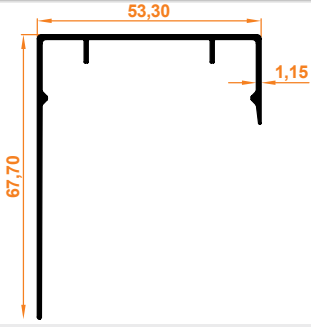

Sonlandırıcı Cam Çıta Kapak Profili
End Cap Glass Strip Cover Profile

418

0,329 kg/m

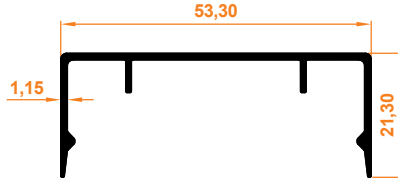

Cam Çıta Kapak Profili
Glass Strip Cover Profile

419

2,100 kg/m

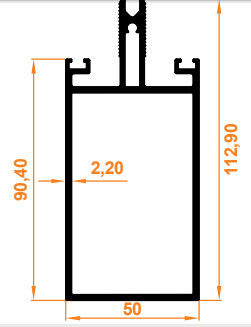

Orta Kayıt Profili
Center Mullion Profile

420

0,682 kg/m

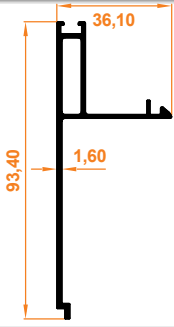

Kasa Kapatma Profili
Frame Closure Profile

421

3,184 kg/m

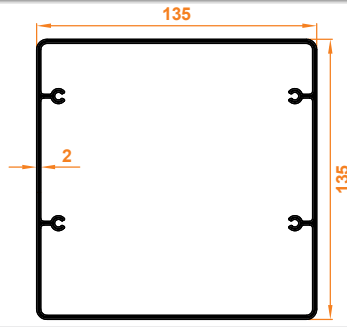

Ayak Profili
Leg Profile

422

4,318 kg/m

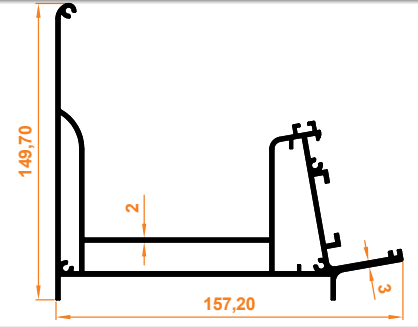

Oluk Profili
Groove Profile

423

3,142 kg/m

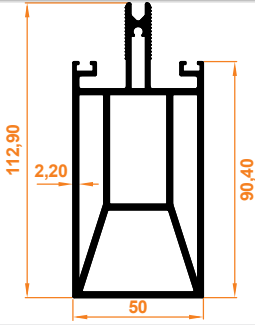

Destekli Orta Kayıt Profili
Reinforced Center Mullion Profile

424

2,835 kg/m

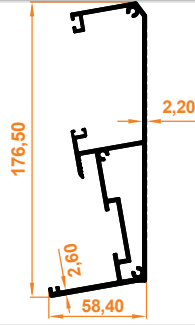

Duvar Kasa Profili
Wall Frame Profile

425

0,847 kg/m

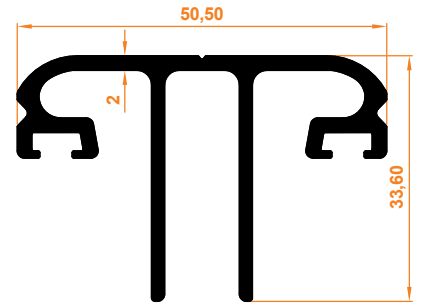

Cam Çıta Profili
Glass Strip Profile

426

3,434 kg/m

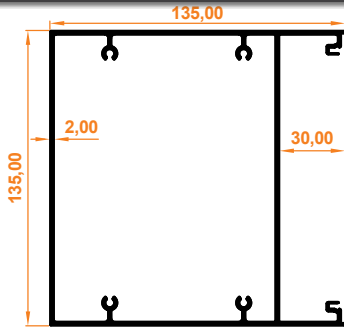

Gizli Ayak Profili
Hidden Leg Profile

427

2,271 kg/m

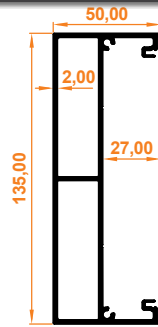

Destek Kutu Profili
Reinforcing Box Profile

428

0,501 kg/m

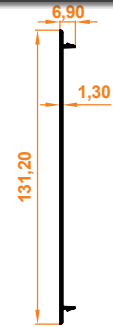

Gizli Ayak ve Destek Kutu Kapatma Profili
Hidden Leg Case Cover Support Profile

C60 SERİ ALÜMİNYUM PROFİL GRUBU

C60 Series Aluminum Profile Group

7100

0,921 kg/m

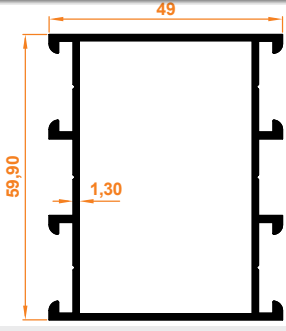

C60 Kasa Orta Kayıt Profili
C60 Case Mid Entry Profile

7101

0,988 kg/m

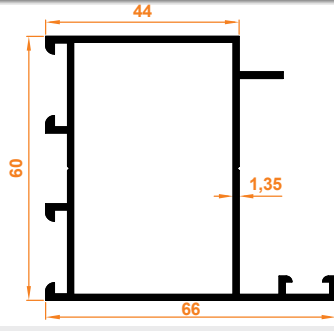

C60 Kanat Profili
C60 Wing Profile

7102

1,440 kg/m

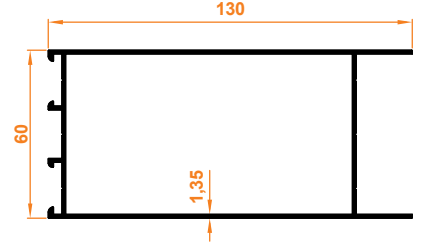

C60 Etek Profili
C60 Skirt Profile

7103

1,099 kg/m

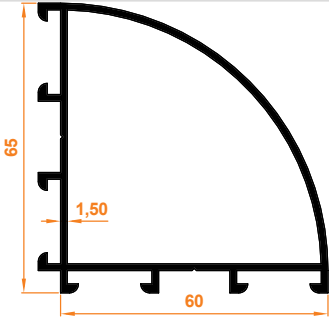

C60 Oval Köşe Dönüş Profili
C60 Oval Corner Profile

7104

0,436 kg/m

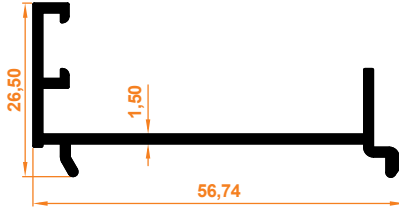

C60 Kanat Adaptörü Profili
C60 Wing Adapter Profile

7105

1,155 kg/m

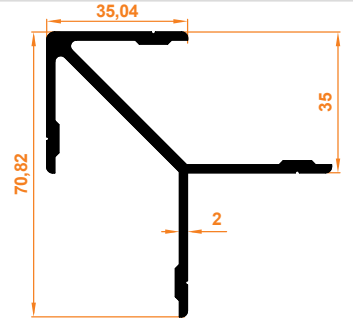

C60 Köşe Takozu
C60 Corner Wedge

7106

0,467 kg/m

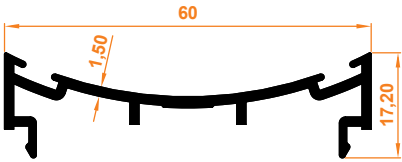

C60 Çarpma Kapı Adaptörü - Dişi
C60 Crash Door Adapter - Female

7107

0,367 kg/m

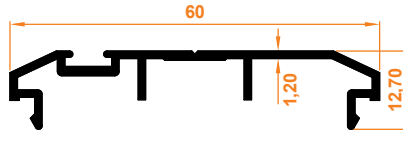

C60 Çarpma Kapı Adaptörü - Erkek
C60 Crash Door Adapter - Male

7108

0,241 kg/m

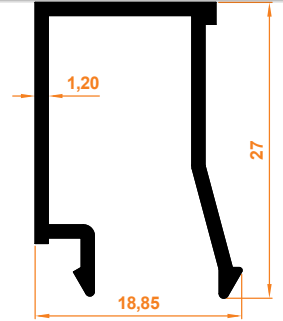

C60 Isıcam Çıta Profili
C60 Insulating Glass Stave Profile

7109

0,234 kg/m

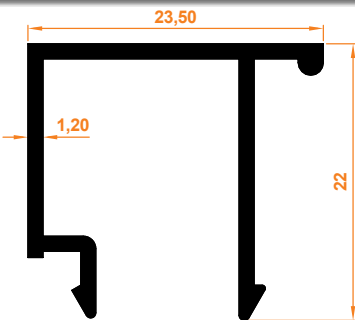

C60 Tek Cam Çıta Profili
C60 Single Glass Stave Profile

7000 0,473 kg/m

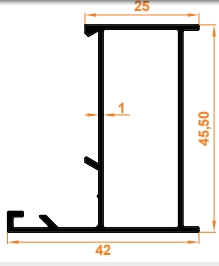

Aldoks (Dar) Kasa Profili
Aldoks (Tight) Frame Profile

7001 0,565 kg/m

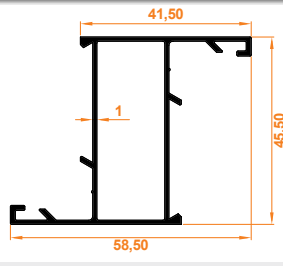

Aldoks (Dar) Kanat Profili
Aldoks (Tight) Wing Profile

7002 0,565 kg/m

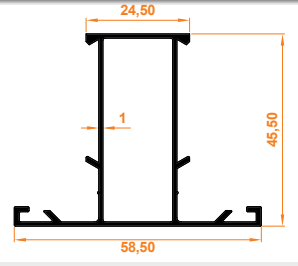

Aldoks (Dar) Orta Kayıt Profili
Aldoks (Tight) Mid Entry Profile

7003 0,891 kg/m

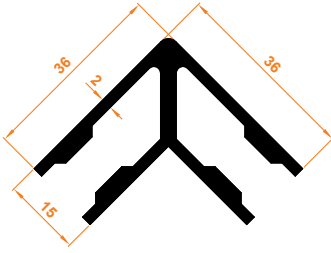

Aldoks (Dar) Köşe Takozu
Aldoks (Tight) Corner Wedge

7004 0,565 kg/m

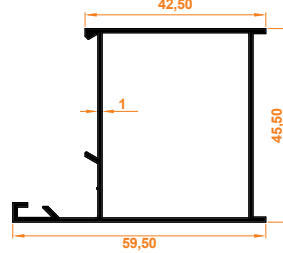

Aldoks (Orta) Kasa Profili
Aldoks (Mid) Frame Profile

7005 0,659 kg/m

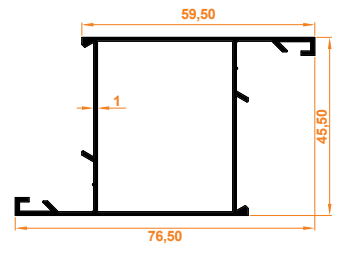

Aldoks (Orta) Kanat Profili
Aldoks (Mid) Wing Profile

7006 0,659 kg/m

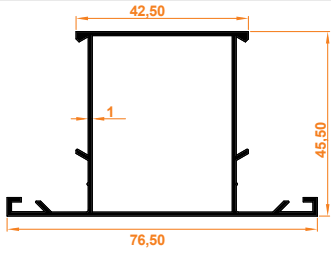

Aldoks (Orta) Kayıt Profili
Aldoks (Mid) Entry Profile

7007 1,136 kg/m

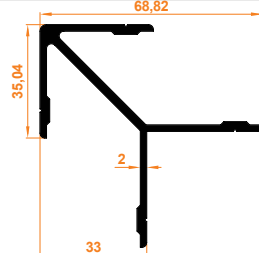

Aldoks (Orta) Köşe Takozu
Aldoks (Mid) Corner Wedge

7008 0,695 kg/m

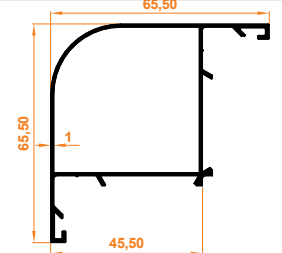

Aldoks Oval Köşe Dönüş Profili
Aldoks Oval Corner Profile

7009 0,719 kg/m

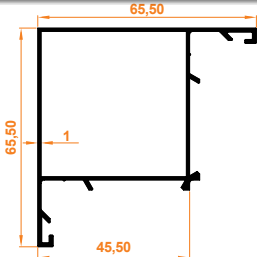

Aldoks Köşe Dönüş Profili
Aldoks Corner Profile

7010 1,028 kg/m

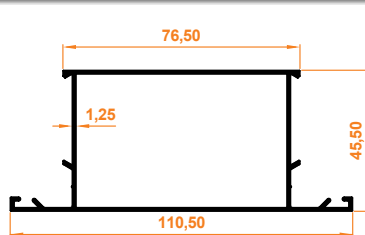

Aldoks (Geniş) Orta Kayıt Profili
Aldoks (Wide) Mid Entry Profile

7011 1,028 kg/m

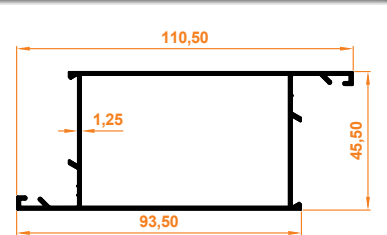

Aldoks (Geniş) Kanat Profili
Aldoks (Wide) Wing Profile

7012 1,149 kg/m

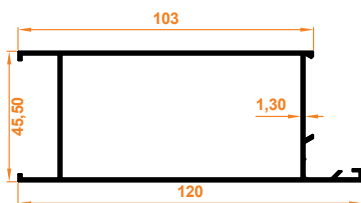

Aldoks Etek Profili
Aldoks Skirt Profile

7013 0,215 kg/m

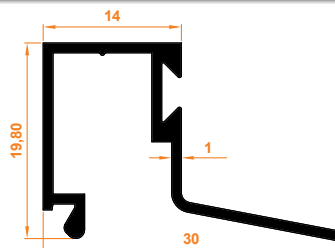

Aldoks Isıcam Çita
Aldoks Double Glazing Stave

7014 0,213 kg/m

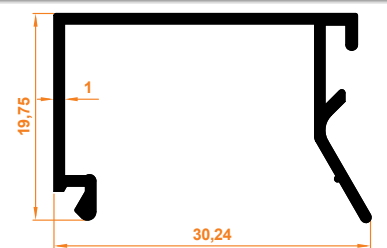

Aldoks Tek Cam Çita
Aldoks Single Glass Stave

700

0,185 kg/m

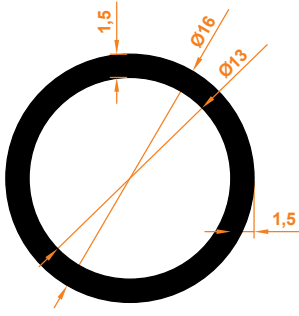

16x1,5 Boru
16x1,5 Pipe

701

0,538 kg/m

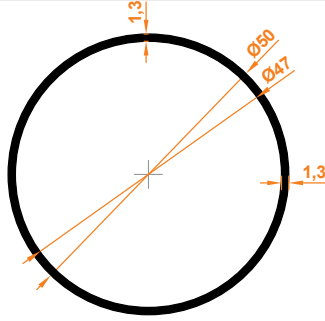

50x1,3 Boru
50x1,3 Pipe

702

0,509 kg/m

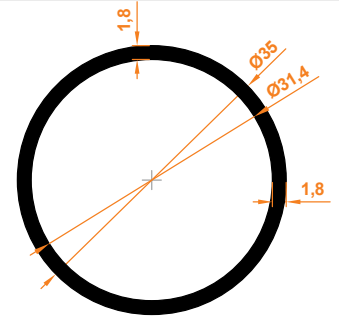

35x1,8 Boru
35x1,8 Pipe

703

0,182 kg/m

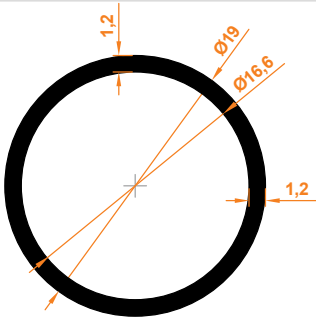

19x1,2 Boru
19x1,2 Pipe

704

0,162 kg/m

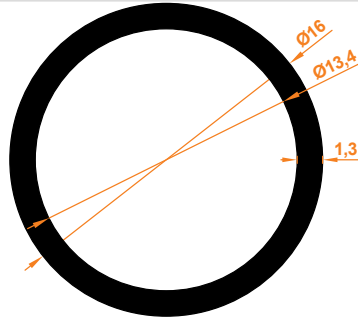

16x1,3 Boru
16x1,3 Pipe

900

0,685 kg/m

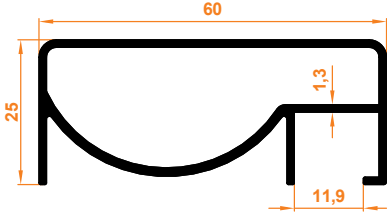

60x25 mm Üst Küpeşte Yandan Kanallı
60x25 mm Upper Handrail with Side Channel

901

0,230 kg/m

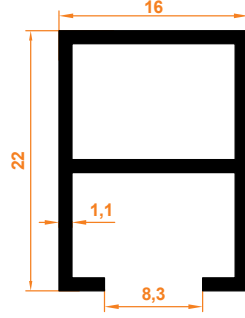

Cam Tutucu
Glass Holder

902

0,848 kg/m

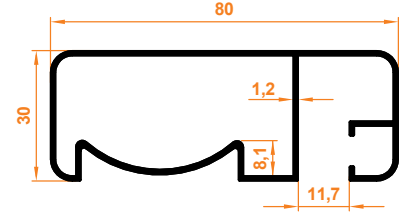

80x30 Yandan Kanallı
80x30 Side Channel

903

0,785 kg/m

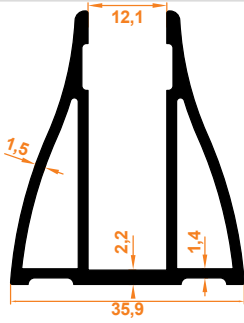

Cam Alt Baza
Glass Bottom Base

904

0,159 kg/m

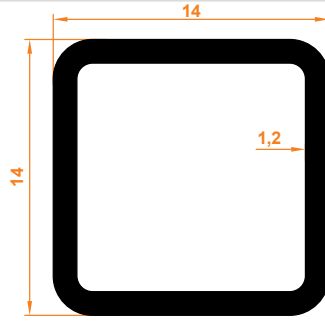

14x14 Emniyet Şeridi
14x14 Safety Strip

905

0,060 kg/m

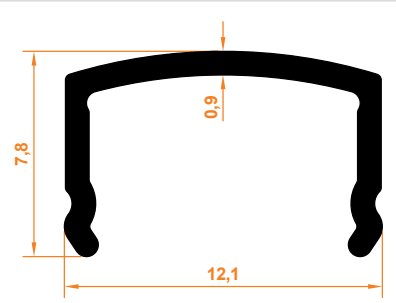

Boru Çıtası
Pipe Lath

906

0,650 kg/m

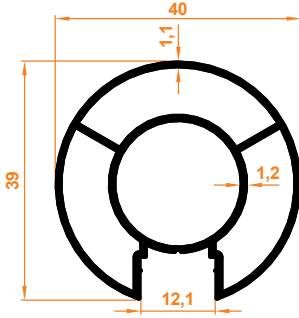

40x1,1 mm Tek Kanallı Çiftli Dikme
40x1,1 mm Single Channel Double Column

907

0,532 kg/m

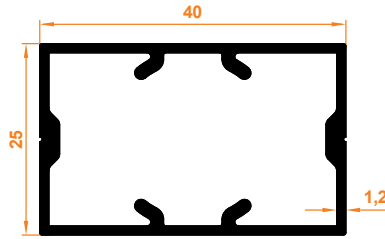

40x25 Dikme
40x25 Column

908

0,922 kg/m

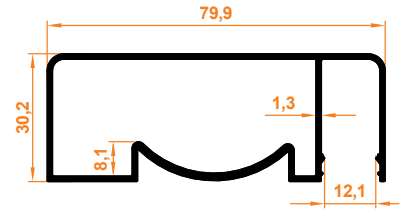

80x30 Yandan Kanallı
80x30 Side Channel

909

0,717 kg/m

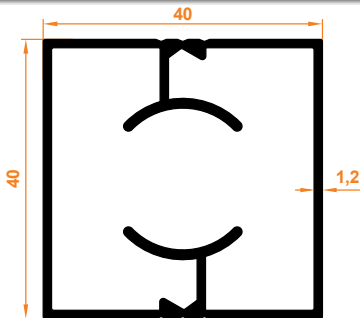

40x40 Kanalsız Dikme
40x40 Non Channel Column

910

0,631 kg/m

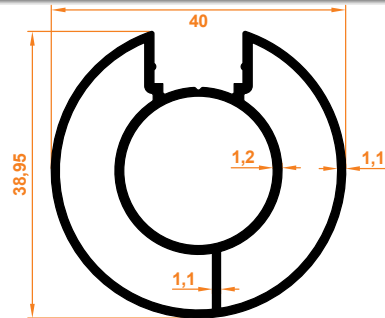

40x1,1 mm Tek Kanallı Tekli Dikme
40x1,1 mm Single Channel Single Column

911

0,840 kg/m

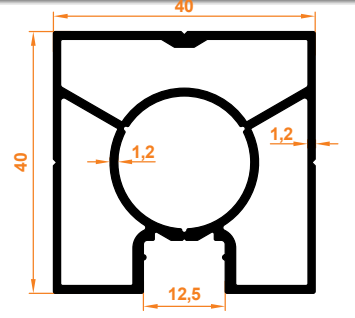

40x40 Tek Kanallı Dikme
40x40 Single Channel Column

912

0,641 kg/m

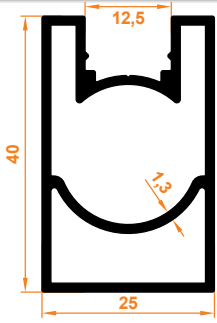

40x25 Tek Kanallı
40x25 Single Slot

913

0,664 kg/m

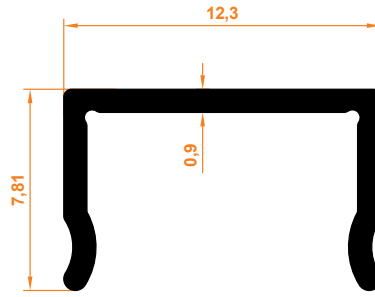

Kare Çıta
Square Slot

914

0,082 kg/m

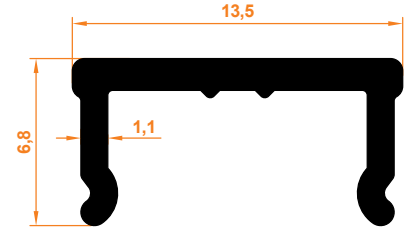

80x30 Yandan Kanallı Çıtası
80x30 Side Slot Rail

915

0,778 kg/m

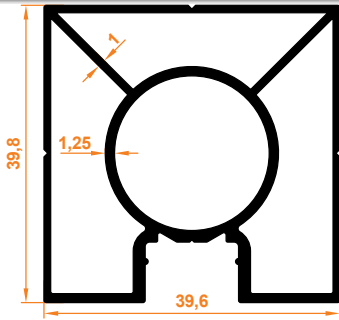

40x40 Tek Kanallı Dikme
40x40 Single Slot Column

916

0,627 kg/m

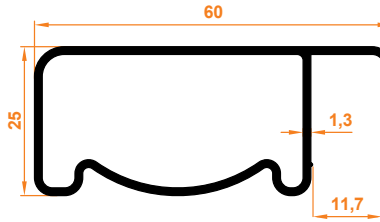

60x25 Yandan Kanallı
60x25 Side Slot

918

0,256 kg/m

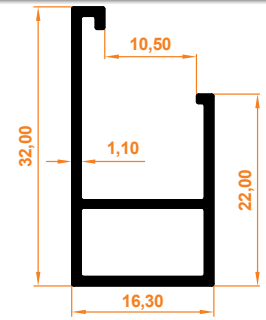

8-10 mm Cam Altı Profil
8-10 mm Glass Bottom

919

0,807 kg/m

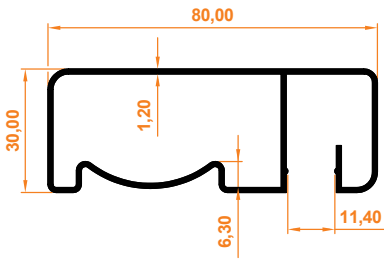

80x30 Yandan Kanallı
80x30 Side Slot

250 1,291 kg/m

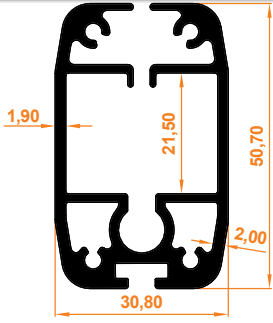

Kanat Profili
Wing Profile

251 0,572 kg/m

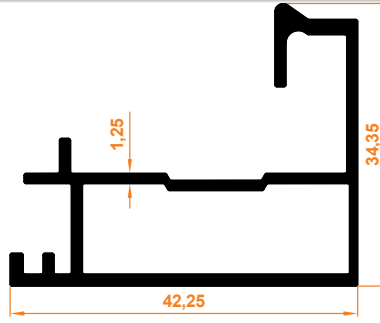

Yan Kasa Profili
Side Case Profile

252 0,313 kg/m

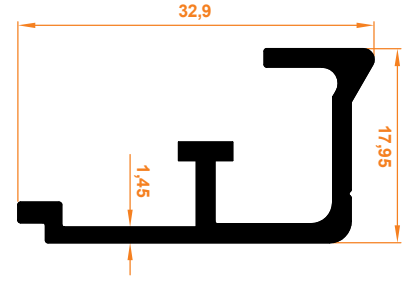

Yan Kasa Kapak Profili
Side Case Cover Profile

7150 1,776 kg/m

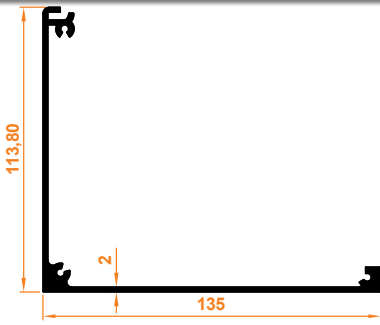

Üst Kasa Profili
Upper Case Profile

7151 1,475 kg/m

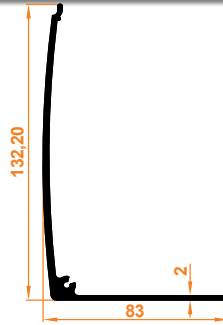

Üst Kasa Kapak Profili
Upper Case Cover Profile

ZP 13 2,110 kg/m

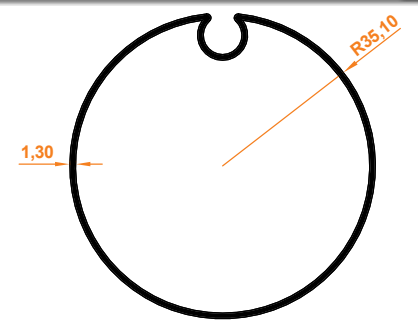

Sac Tambur Borusu
Sheet Drum Tube

ZP 15 0,800 kg/m



5x20 Lama Demir
5x20 Blade Iron

312

0,156 kg/m

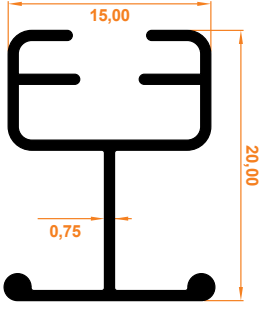

T Profil
T Profile

334

0,265 kg/m

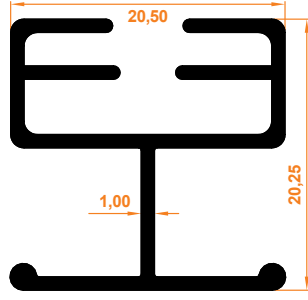

20'lik T Profil
20 T Profile

339

0,102 kg/m

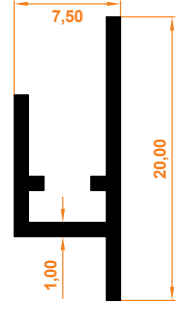

Yaylı Yapışkan Profil
Spring Adhesive Profile

332

0,094 kg/m

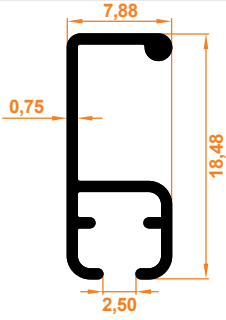

Small T Profil
Small T Profile

340

0,076 kg/m

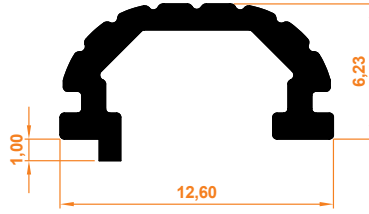

Yaylı Portray Profil
Spring Portray Profile

327

0,252 kg/m

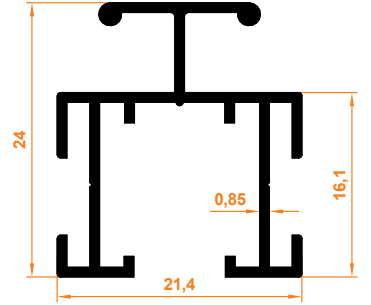

Çiftli Orta Profil
Double Middle Profile

200

0,136 kg/m

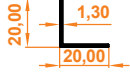

20x20 Köşebent
20x20 Angle Bracket

201

0,207 kg/m

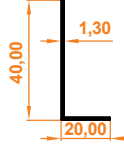

20x40 Köşebent
20x40 Angle Bracket

202

0,277 kg/m

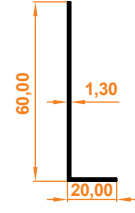

20x60 Köşebent
20x60 Angle Bracket

204

0,347 kg/m

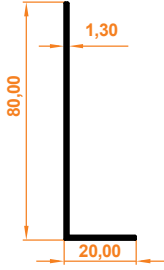

20x80 Köşebent
20x80 Angle Bracket

203

0,418 kg/m

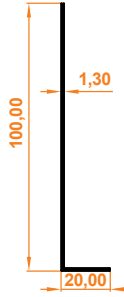

20x100 Köşebent
20x100 Angle Bracket

205

0,488 kg/m

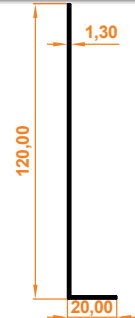

20x120 Köşebent
20x120 Angle Bracket

404

0,384 kg/m

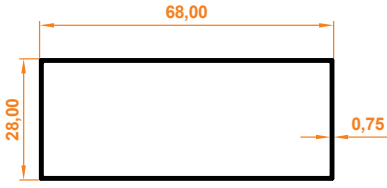

28x68 Kutu Profil
28x68 Box Profile

1044

0,960 kg/m

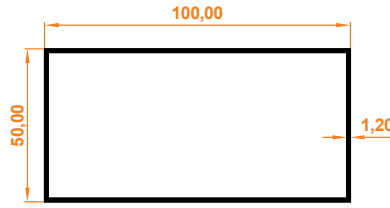

50x100 Kutu Profil
50x100 Box Profile

1102

0,531 kg/m

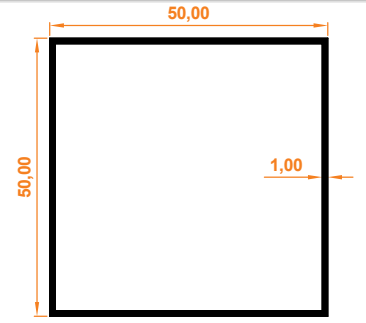

50x50 Kutu Profil
50x50 Box Profile

1400

0,426 kg/m

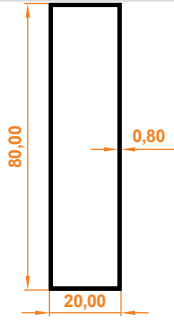

20x80 Kutu Profil
20x80 Box Profile

1402

0,917 kg/m

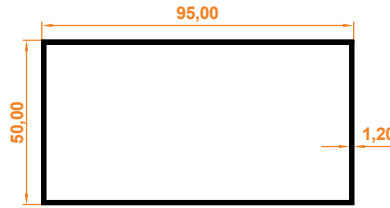

95x50 Kutu Profil
95x50 Box Profile

1403

0,505 kg/m

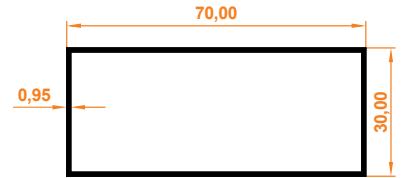

30x70 Kutu Profil
30x70 Box Profile

7

0,305 kg/m

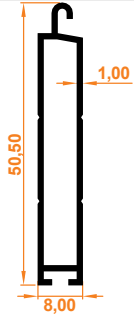

39x55 Alt Parça
39x55 Lower Part

8

0,502 kg/m

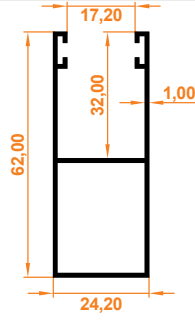

55'lik Yan Dikme
55 Side Column

9

0,439 kg/m

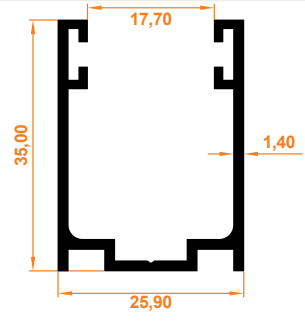

55'lik Kutusuz Dikme
55 Side Column Boxless

1130

0,372 kg/m

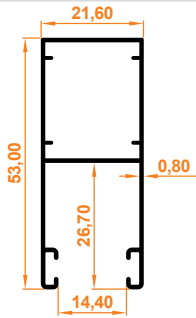

39'luk Yan Dikme
39 Side Column

ÖZEL ÜRETİM PROFİL GRUBU
Special Production Profile Group

510

1,174 kg/m

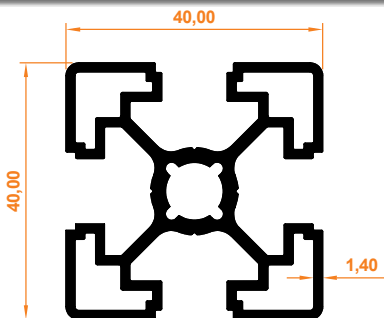

40x40 Sigma Profil
40x40 Sigma Profile

1003

0,053 kg/m

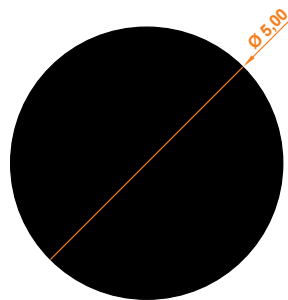

Q5 Dolu Mil
Q5 Solid Bar

İNNOVATİF ÜRETİM
GENİŞ BAYİ AĞI

Sektörde Öncü Marka



INNOVATIVE PRODUCTION
WIDE DISTRIBUTOR NETWORK

Leading Brand in the Industry





 demarco  panjurmen  prosin  process plise

 Process Alüminyum Plastik San. Tic. Ltd. Şti.

MERKEZ

Aşağıpınarbaşı OSB Mah. 524 Nolu Sk. No: 3/1
42250, Selçuklu-Konya/TÜRKİYE

T : +90 332 248 00 92

F : +90 332 248 00 93

M : info@process.com.tr

MARMARA BÖLGE MÜDÜRLÜĞÜ

Cihangir Mh. Talatpaşa Cad. No:67
Avcılar/İSTANBUL - TÜRKİYE

T : +90 212 407 17 42

F : +90 212 407 15 42

M : marmara@process.com.tr

www.demarco.com.tr

www.processplise.com.tr

www.panjurmen.com.tr

www.prosin.com.tr

www.process.com.tr

