



Firmamız, **Process Alüminyum ve PVC Sistemleri** ünvanıyla 2002 yılında Konya'da kurulmuştur.

Firmamızın uzmanlaştığı üretim alanları; sineklik sistemleri, cam balkon sistemleri, plise perde sistemleri, zip perde, cam tavan ve tavan kapatma sistemleridir. Tüm bu sistemleri oluşturan plastik aksesuarlar, alüminyum profiller ve polyester tül ile plise perde kumaşları, kendi tesislerimizde üretilmektedir. Tesisimiz 35.000 m² kapalı, 15.000 m² açık alanı olmak üzere toplam 50.000 m²'dir. Plastik enjeksiyon üretim bölümünde 15 adet enjeksiyon makinesi ile 24 saat çalışma esasıyla günlük ortalama 300.000 adet parça üretebilmektedir. Alüminyum ekstrüzyon bölümümüzde aylık ortalama 850 ton alüminyum profil üretilmektedir. Üretilen alüminyum profiller yine kendi tesisimizde yüzey işlemlerinden (eloksal - elektrostatik boya) geçmekte ve son olarak paketlenip sevk edilmektedir. Türkiye içerisinde 900 civarında atölyede ürünlerimiz işlenmekte ve son tüketiciye ulaştırılmaktadır. Türkiye dışında Balkan ülkelerinin tamamı, Avrupa Kıtasında; Almanya, Hollanda, Danimarka, Kuzey Afrikada; Tunus ve Cezayir, Orta Doğuda; Irak ve İsrail'in yanısıra Ermenistan, Azerbaycan, Arap Emirlikleri, Dubai, Katar, Ürdün gibi ülkelerde bayilikler oluşturulmuştur. Şu anda toplam ürünlerimizin %35'ini ihraç etmekteyiz.

Perde sektöründe son zamanların trend ürünü olan plise perde sistemlerini kendi Ar-Ge merkezimizde geliştirerek sektörün hizmetine sunmuş bulunmaktadır. Mekanik perde atölyeleri tarafından bugüne kadar Türkiye genelinde 150 adet bayilik oluşturulmuş ve bu bayilikler artarak çoğalmaktadır. Plise perdeyi oluşturan tüm parçaları; plastik aksesuarlar, alüminyum çita ve profiller, katlanmış pileli kumaşlar ürünlerimizi kendi tesislerimizde üretilip bayilerimize ulaştırmaktayız. 167 farklı desen ve renkte kumaş çeşidi olan firmamız çok güçlü stok altyapısı ile sektörün ihtiyacı olan hizmeti ve hızı sunmaktadır.

Our company, operating under the name of **Process Aluminum and PVC Systems**, was founded in 2002 in Konya.

Process specializes in the production of the following areas: insect screen systems, glass balcony systems, pleated blind systems, zip blinds, glass roofs, and ceiling closure systems. All the plastic accessories, aluminum profiles, polyester mesh, and pleated blind fabrics that make up these systems are manufactured in our own facilities. Our facility covers a total area of 50,000 m², with 35,000 m² being indoors and 15,000 m² outdoors. In the plastic injection production department, we can produce an average of 300,000 pieces per day with 15 injection machines operating 24 hours a day. In our aluminum extrusion department, an average of 850 tons of aluminum profiles are produced monthly. The aluminum profiles produced undergo surface treatments (anodizing - electrostatic paint) in our own facilities before being packaged and shipped. Within Turkey, our products are processed in approximately 900 workshops and delivered to end consumers. Outside of Turkey, we have established dealerships in all Balkan countries, across the European continent including Germany, the Netherlands, and Denmark, in North Africa including Tunisia and Algeria, in the Middle East including Iraq and Israel, as well as in countries such as Armenia, Azerbaijan, the United Arab Emirates, Dubai, Qatar, Jordan, and more. Currently, we export 35% of our total products.

In the curtain sector, our company has developed and introduced pleated blind systems, the trend product of recent years, to the sector through our own R&D center. Nowadays, we have established 150 dealerships across Turkey in the mechanical curtain workshops, and these dealerships continue to increase. We manufacture all the components that make up pleated blinds, including plastic accessories, aluminum bars, profiles, and folded pleated fabrics, in our own facilities and deliver them to our dealers. With 167 different patterns and colors of fabric, our company provides the service and speed that the sector needs with its strong stock infrastructure.





GELECEK YAPI MİMARİ
Tüm Yaşam Alanlarında

In all living areas

Future Structure Architecture



KALİTE
QUALITY

EKONOMİK
ECONOMIC

GARANTİ
WARRANTY



ÜRÜN KODU Product Code	ÖZELLİKLERİ Properties	ÖLÇÜLERİ Dimensions	KOLI İÇİ ADET Amount within Parcel
PJM - 01	Panjurmen Menfez / Vent	27 x 32	20
PJM - 02	Panjurmen Menfez / Vent	25 x 45	20
PJM - 19	Panjurmen Menfez / Vent	30 x 30	20
PJM - 16	Panjurmen Menfez / Vent	30 x 40	20
PJM - 03	Panjurmen Menfez / Vent	35 x 35	20
PJM - 04	Panjurmen Menfez / Vent	35 x 45	20
PJM - 05	Panjurmen Menfez / Vent	35 x 55	20
PJM - 06	Panjurmen Menfez / Vent	40 x 40	20
PJM - 15	Panjurmen Menfez / Vent	40 x 50	20
PJM - 07	Panjurmen Menfez / Vent	45 x 45	20
PJM - 08	Panjurmen Menfez / Vent	45 x 55	20
PJM - 09	Panjurmen Menfez / Vent	45 x 65	20
PJM - 10	Panjurmen Menfez / Vent	65 x 45	20
PJM - 11	Panjurmen Menfez / Vent	50 x 50	20
PJM - 17	Panjurmen Menfez / Vent	50 x 60	20
PJM - 12	Panjurmen Menfez / Vent	55 x 55	20
PJM - 13	Panjurmen Menfez / Vent	55 x 65	20
PJM - 18	Panjurmen Menfez / Vent	60 x 60	20
PJM - 14	Panjurmen Menfez / Vent	65 x 65	15

Alüminyum Renk Seçeneği

Aluminum Color Options

PB

Parlak Eloksal
Gloss Anodized

P0

Parlak Bronz
Gloss Bronze

7016

Antrasit Gri
Anthracite Gray



ÜRÜN ADI Product Name	ÜRÜN KODU Product Code	KOLİ İÇİ ADET Amount within Parcel
Boru Tipi Çamaşır Askısı Pipe Type Clotheshorse	CMS 01	20



ÜRÜN ADI Product Name	ÜRÜN KODU Product Code	KOLİ İÇİ ADET Amount within Parcel
Lüks Çamaşır Askısı Luxurious Clotheshorse	CMS 04	20



ÜRÜN ADI Product Name	ÜRÜN KODU Product Code	KOLİ İÇİ ADET Amount within Parcel
Ayarlı Kare Çamaşırılık (25x60cm ve 30x80 cm) Adjustable Square Clotheshorse (25x60cm and 30x80cm)	CMS 05	20



ÜRÜN ADI Product Name	ÜRÜN KODU Product Code	KOLİ İÇİ ADET Amount within Parcel
Duvar Tipi Çamaşır Askısı Wall Type Clotheshorse	CMS 02	15



ÜRÜN ADI Product Name	AÇIKLAMA Explanation
Doğalgaz Takım (Isıcam) Natural Gas Set (Double-Glass)	3 m
Doğalgaz Sağ-Sol Başlık Natural Gas Right-Left Header (CAP)	Adet Pcs
Doğalgaz Takım (Tekcam 8mm) Natural Gas Set (Single-Glass 8mm)	3 m
Doğalgaz Takım (Tekcam 10mm) Natural Gas Set (Single-Glass 10mm)	Adet Pcs
Doğalgaz Sağ-Sol Başlık Natural Gas Right-Left Header (CAP)	3 m
Oda Havalandırma Room Ventilation	3 m
Sağ-Sol Başlık Right Left Header (CAP)	Adet Pcs

ONAYLI ÜRÜN
APPROVED PRODUCT



Ürünlerimiz Patentli Olup;
IGDAŞ Onaylıdır.

Our products have patent
and approved by IGDAŞ.

AYARLI CAM TAKOZU

Adjustable Glass Wedges

ÜRÜN ADI Product Name	ÜRÜN KODU Product Code	KOLİ İÇİ ADET (m ²) Amount within Parcel (m ²)
18 mm Ayarlı Cam Takozu / 18 mm Adjustable Glass Wedge	ACT 1	500
24 mm Ayarlı Cam Takozu / 24 mm Adjustable Glass Wedge	ACT 2	400
28 mm Ayarlı Cam Takozu / 28 mm Adjustable Glass Wedge	ACT 3	400
32 mm Ayarlı Cam Takozu / 32 mm Adjustable Glass Wedge	ACT 4	400
Ayarlı Cam Takozu Pensesi / Adjustable Glass Wedge Holder	ACT 5	1



ÖZELLİKLER

PROPERTIES

Kanat sarkmalarını ortadan kaldırır.
It removes wing sagging.

PVC, ahşap ve alüminyum doğramalarda kullanılabilir.
It can be used in PVC, wood and aluminum joiner.

Ayar pensesi sayesinde kanadınızın kolaylıkla teraziye alınmasını sağlar.
It provides balancing your wind easily by means of adjustment claw.

Ekstra takoz seçeneğiyle standartların üzerinde kaldırma kapasitesine sahiptir.
It has lifting capacity over standard by means of extra wedge option.





ÜRÜN KODU Product Code	ÖLÇÜLERİ Dimensions	KOLI İÇİ RULO Amount within Parcel (roll)	RULO/METRE Roll/Meter	KOLI İÇİ ADET (m) Amount within Parcel (m)
FİTİL 72	45-800	4	275	1.100
FİTİL 01	48-300	4	800	3.200
FİTİL 02	48-450	4	550	2.200
FİTİL 03	48-500	4	550	2.200
FİTİL 04	48-550	4	500	2.000
FİTİL 05	48-600	4	450	1.800
FİTİL 06	48-650	4	450	1.800
FİTİL 07	48-700	4	400	1.600
FİTİL 08	48-800	4	275	1.100
FİTİL 66	48-900	4	250	1.000
FİTİL 09	48-1000	4	250	1.000
FİTİL 10	48-1200	4	200	800
FİTİL 60	48-1500	4	150	600
FİTİL 11	51-500	4	375	1.500
FİTİL 54	51-550	4	375	1.500
FİTİL 12	51-650	4	350	1.400
FİTİL 13	51-800	4	325	1.300
FİTİL 14	51-1000	4	250	1.000
FİTİL 15	51-1200	4	200	800
FİTİL 16	55-550	4	375	1.500
FİTİL 68	55-600	4	350	1.400
FİTİL 67	55-650	4	350	1.400
FİTİL 17	55-700	4	350	1.400
FİTİL 18	55-800	4	325	1.300
FİTİL 65	55-1000	4	250	1.000
FİTİL 19	60-575	4	350	1.400
FİTİL 20	67-450	4	375	1.500
FİTİL 21	67-500	4	375	1.500
FİTİL 22	67-550	4	375	1.500
FİTİL 23	67-600	4	350	1.400
FİTİL 24	67-650	4	350	1.400
FİTİL 46	67-700	4	300	1.200
FİTİL 26	67-800	4	250	1.000
FİTİL 61	67-900	4	225	900
FİTİL 28	67-1000	4	200	800
FİTİL 29	67-1100	4	175	700
FİTİL 30	67-1200	4	175	700
FİTİL 31	67-1500	4	125	500
FİTİL 32	67-1800	4	125	500
FİTİL 33	67-2000	4	100	400
FİTİL 74	67-2500	4	75	300
FİTİL 34	69-550	4	375	1.500
FİTİL 35	69-700	4	250	1.000
FİTİL 36	69-1000	4	200	800
FİTİL 37	69-1200	4	175	700
FİTİL 38	72-800	4	200	800
FİTİL 39	127-700	4	175	700
FİTİL 73	51-550 Finli	4	350	1.400
FİTİL 40	51-650 Finli	4	325	1.300
FİTİL 41	51-800 Finli	4	300	1.200
FİTİL 42	51-1000 Finli	4	225	900
FİTİL 77	55-650 Finli	4	325	1.300
FİTİL 43	55-700 Finli	4	325	1.300
FİTİL 44	55-800 Finli	4	300	1.200
FİTİL 45	60-575 Finli	4	325	1.300
FİTİL 76	67-600 Finli	4	325	1.300
FİTİL 55	67-650 Finli	4	325	1.300
FİTİL 58	67-700 Finli	4	275	1.100
FİTİL 47	67-1000 Finli	4	175	700
FİTİL48	67-1200 Finli	4	150	600
FİTİL 49	69-700 Finli	4	225	900
FİTİL 50	69-800 Finli	4	225	900
FİTİL 51	69-1000 Finli	4	175	700
FİTİL 52	72-800 Finli	4	175	700
FİTİL 53	127-700 Finli	4	150	600

ÜRÜN ADI Product Name	ÜRÜN KODU Product Code	RULO m ² Roll m ²	KOLI İÇİ ADET (m ²) Amount within Parcel (m ²)
60cmx30m Sineklik Tülü / 60cmx30m Flynet Tulle	60 S	18 m ²	6
80cmx30m Sineklik Tülü / 80cmx30m Flynet Tulle	80 S	24 m ²	6
100cmx30m Sineklik Tülü / 100cmx30m Flynet Tulle	100 S	30 m ²	6
120cmx30m Sineklik Tülü / 120cmx30m Flynet Tulle	120 S	36 m ²	6
140cmx30m Sineklik Tülü / 140cmx30m Flynet Tulle	140 S	42 m ²	6
160cmx30m Sineklik Tülü / 160cmx30m Flynet Tulle	160 S	48 m ²	6
180cmx30m Sineklik Tülü / 180cmx30m Flynet Tulle	180 S	54 m ²	6
200cmx30m Sineklik Tülü / 200cmx30m Flynet Tulle	200 S	60 m ²	6
220cmx30m Sineklik Tülü / 220cmx30m Flynet Tulle	220 S	66 m ²	6
240cmx30m Sineklik Tülü / 240cmx30m Flynet Tulle	240 S	72 m ²	6
Pet Tül 160 / Pet Tulle 160	160 PET	16 m ²	6
Pet Tül 220 / Pet Tulle 220	220 PET	22 m ²	6

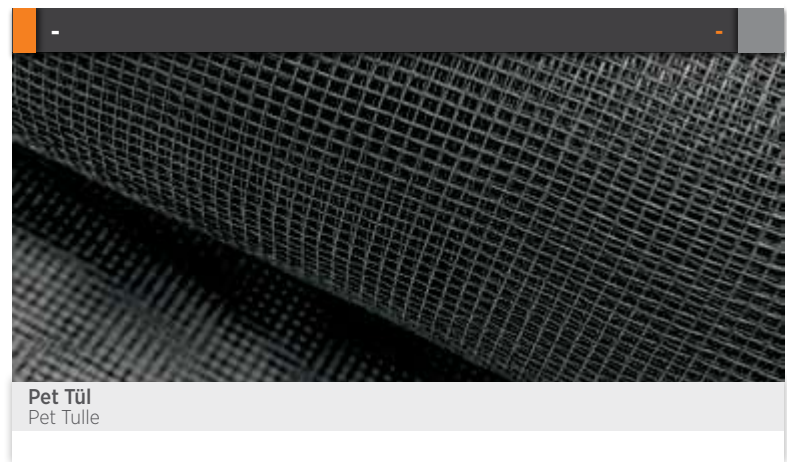

GOLD SERİ PLİSE SİNEKLİK / GOLD SERIES PLEATED FLY SCREEN

İçten Gergi

Internal Tensioner

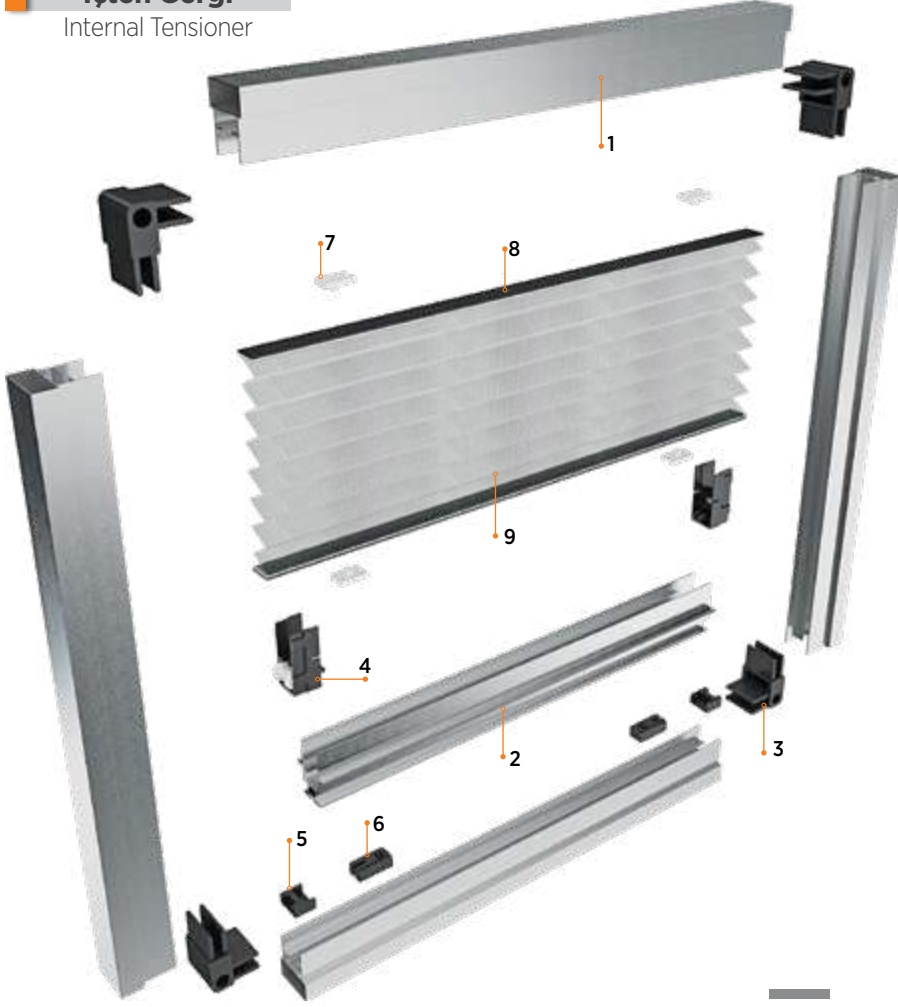

İçten Gergi Set İçeriği / Internal Tensioner Set Contents

No	ÜRÜN KODU Product Code	ÜRÜN ADI Product Name
1	304	Gold Kasa Gold Case
2	305	Gold Kanat Gold Wing
3	-	Köşe Takoğu Corner Wedge
4	-	Rulman Takımı Bearing Set
5	-	İp Kontrol Plastiği Rope Control Plastic
6	-	İp Gergi Takoğu Rope Tensioner Chock
7	-	Delikli Klips Hole Clip
8	-	Plise Serit Pleat Ribbon
9	-	Plise Tül Pleat Tulle

Özellikle kapılar için çok tercih edilen bir seridir, tül ağı bir tarafta veya her iki tarafta kasa içerisine katlanır.

Pileli kaset, alüminyum kasa profili ile kapı veya pencere pervazına, köşe takozlarında yer alan montaj deliklerinden vida yardımıyla doğrudan ve kolayca sabitlenir.

This model is a terrifically preferential profile particularly for doors, tulle is folded into the one side of the case frame or even two sides of the case frame.

The pleated tape is fastened straightly and easily to the door or window sill with the support of screws through the mounting holes in the corner wedges with the aluminum frame case profile.



Gold Kasa Profil Gold Case Profile			
Paket İçi Adet Amount within package	10	Gramajı Weight	0,318 kg/m



Gold Kanat Profil Gold Wing profile			
Paket İçi Adet Amount within package	10	Gramajı Weight	0,330 kg/m



Gold Seri İçten Gergi Aksesuar Seti Gold Serie Internal Tensioner Accessory Set			
Koli İçi Adet Amount within parcel	100 Set		

Alüminyum Renk Seçeneği

Aluminum Color Options

9016

Beyaz
White

Eloksal Boyalı
Anodized Painted

Bronz Boyalı
Bronze Painted

8003

Altın Meşe
Golden Oak

8016

Maun
Mahogany

7016

Antrasit Gri
Anthracite Gray

STAR SERİ PLİSE SİNEKLİK / STAR SERIES PLEATED FLY SCREEN

Köşeden Gergi

Corner Tensioner



Kanat hareketliliğini sağlayan ipler kasa içerisinde ip gergi aparatı ile sabitlenen modelinin yanı sıra köşe takozunda yer alan ip gergi vida ile ipin sabitlendiği modeli de mevcuttur.

Kasa genişliği Gold seriye göre daha dar olduğu için kimi alanlarda montaj kolaylığı sağlamaktadır.

The rope which lets the wing frame move is stabled with the rope tensioner in the case frame. Also, this rope is fixed with the rope tension screw in the corner of the profile.

Due to the case frame width of the Star Series is narrower than the Gold series, in some areas it provides simple installation.

İçten Gergi

Internal Tensioner



İçten Gergi Set İçeriği / Internal Tensioner Set Contents

No	ÜRÜN KODU Product Code	ÜRÜN ADI Product Name
1	302	Star Kasa Star Case
2	301	Star Kanat Star Wing
3	-	Köşe Takozu Corner Wedge
4	-	Rulman Takımı Bearing Set
5	-	İp Kontrol Rope Control
6	-	İp Gergi Takozu Rope Tensioner Chock
7	-	Delikli Klips Hole Clip
8	-	Plise Tül Pleat Tulle
9	-	Plise Şerit Pleat Ribbon

Köşeden Gergi Set İçeriği / Corner Tensioner Set Contents

No	ÜRÜN KODU Product Code	ÜRÜN ADI Product Name
1	302	Star Kasa Star Case
2	301	Star Kanat Star Wing
3	-	Köşe Takozu Corner Wedge
4	-	Rulman Takımı Bearing Set
5	-	Plise Şerit Pleat Ribbon
6	-	Delikli Klips Hole Clip
7	-	Plise Tül Pleat Tulle

AKS 05
AKS 06

Beyaz / White
Siyah / Black



Star Seri Köşeden Gergi Aksesuar Seti
Star Series Corner Tensioner Accessory Set

Koli İçi Adet
Amount within parcel

100 Set

AKS 07
AKS 08

Beyaz / White
Siyah / Black



Star Seri İçten Gergi Aksesuar Seti
Star Serie Internal Tensioner Accessory Set

Koli İçi Adet
Amount within parcel

100 Set

301



Star Kanat Profil
Star Wing Profile

Paket İçi Adet
Amount within package

10

Gramajı
Weight

0,303 kg/m

302



Star Kasa Profil
Star Case Profile

Paket İçi Adet
Amount within package

10

Gramajı
Weight

0,272 kg/m

Alüminyum Renk Seçeneği

Aluminum Color Options

9016

Beyaz
White

Eloksal Boyalı
Anodized Painted

Bronz Boyalı
Bronze Painted

8003

Altın Meşe
Golden Oak

8016

Maun
Mahogany

7016

Antrasit Gri
Anthracite Gray

SLİM SERİ PLİSE SİNEKLİK / SLIM SERIES PLEATED FLY SCREEN

Köşeden Gergi

Corner Tensioner

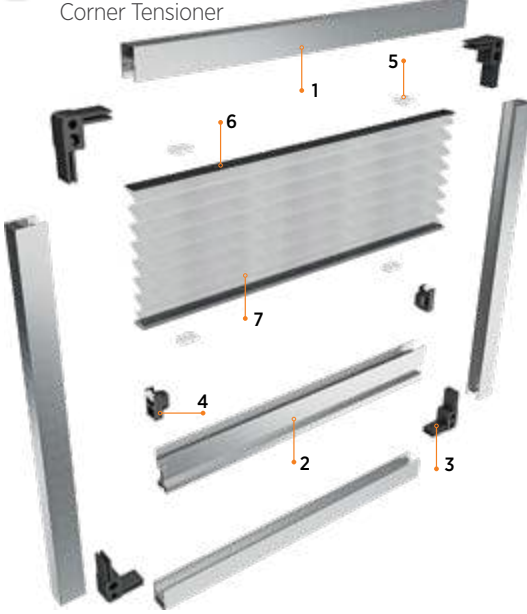

Köşeden Gergi Set İçeriği / Corner Tensioner Set Contents

No	ÜRÜN KODU Product Code	ÜRÜN ADI Product Name
1	300	Slım Kasa Slim Case
2	301	Slım Kanat Slim Wing
3	-	Köşe Birleştirme Corner Wedge
4	-	Rulman Takımı Bearing Set
5	-	Delik Klips Hole Clip
6	-	Plıse Şerit Pleat Ribbon
7	-	Plıse Tül Pleat Tulle

İçten Gergi

Internal Tensioner



İçten Gergi Set İçeriği / Internal Tensioner Set Contents

No	ÜRÜN KODU Product Code	ÜRÜN ADI Product Name
1	300	Slım Kasa Slim Case
2	301	Slım Kanat Slim Wing
3	-	Köşe Birleştirme Corner Wedge
4	-	Kanat Kapağı Wing Cover
5	-	İp Gergi Takozu Rope Tensioner Chock
6	-	İp Kontrol Plastiği Rope Control Plastic
7	-	Delikli Klips Hole Clip
8	-	Plıse Şerit Pleat Ribbon
9	-	Plıse Tül Pleat Tulle

Alüminyum Renk Seçeneği

Aluminum Color Options



AKS 01 / Beyaz / White AKS 02 / Siyah / Black



Slım Seri Köşeden Gergi Aksesuar Seti Slim Series Corner Tensioner Accessory Set

Koli İçi Adet
Amount within parcel

100 Set

AKS 01 E / Beyaz / White AKS 02 E / Siyah / Black

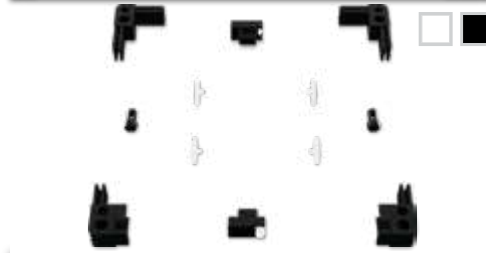

Slım Köşeden Gergi Eşiksiz Aksesuar Seti Slim Corner Tensioner Accessory Set without Threshold

Koli İçi Adet
Amount within parcel

100 Set

AKS 03 / Beyaz / White AKS 04 / Siyah / Black

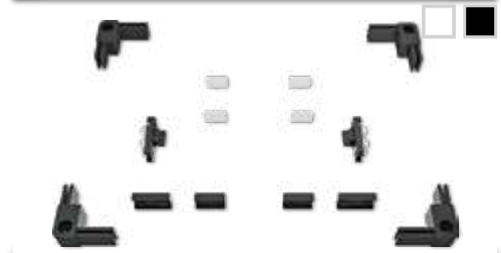

Slım Seri İçten Gergi Aksesuar Seti Slim Serie Internal Tensioner Accessory Set

Koli İçi Adet
Amount within parcel

100 Set

300



Slım Kasa Profil Slim Case Profile

Paket İçi Adet
Amount within package

10

Gramajı
Weight

0,218 kg/m

331



Slım Eşiksiz Profil Slim Profile without Threshold

Paket İçi Adet
Amount within package

10

Gramajı
Weight

0,168 kg/m

301



Slım Kanat Profil Slim Wing Profile

Paket İçi Adet
Amount within package

10

Gramajı
Weight

0,303 kg/m

JUNIOR SERİ PLİSE SİNEKLİK / JUNIOR SERIES PLEATED FLY SCREEN

Köşeden Gergi

Corner Tensioner



Köşeden Gergi Set İçeriği / Corner Tensioner Set Contents

No	ÜRÜN KODU Product Code	ÜRÜN ADI Product Name
1	306	Junior Kasa Profili Junior Case Profile
2	307	Junior Kanat Profili Junior Wing Profile
3	-	Köşe Birleştirme Corner Wedge
4	-	Rulman Takımı Bearing Set
5	PLS 11	Delikli Klips Hole Clip
6	PLS 05	Plise Şerit Pleat Ribbon
7	PLS 04	Plise Tül Pleat Tulle

Junior Seri, pratik ve estetik bir sineklik çözümü sunar. Köşeden gergi sistemiyle tasarlanan bu model, kullanımı kolay ve dayanıklıdır. Evinize zarif bir görünüm katan Junior Seri, sineklik ihtiyaçlarınızı en iyi şekilde karşılar.

Junior Series offers a practical and aesthetic solution for insect screens. Designed with a corner tensioning system, this model is easy to use and durable. Adding an elegant look to your home, Junior Series meets your insect screen needs perfectly.

AKS 15
AKS 16

Beyaz / White
Siyah / Black



Junior Seri Köşeden Gergi Aksesuar Seti
Junior Seri Corner Tensioner Accessory Set

Koli İçerik Adet
Amount within parcel

100 Set

AKS 15 E
AKS 16 E

Beyaz / White
Siyah / Black



Junior Seri Köşeden Gergi Eşiksiz Aksesuar Seti
Junior Seri Corner Tensioner without Threshold Accessory Set

Koli İçerik Adet
Amount within parcel

100 Set

306



Junior Kasa Profil
Junior Case Profile

Paket İçerik Adet
Amount within package

10

Gramajı
Weight

0,243 kg/m

307



Junior Kanat Profil
Nobel Wing Profile

Paket İçerik Adet
Amount within package

10

Gramajı
Weight

0,304 kg/m

345



Junior Eşiksiz Kasa Profil
Junior Case Profile without Threshold

Paket İçerik Adet
Amount within package

12

Gramajı
Weight

0,162 kg/m

Alüminyum Renk Seçeneği

Aluminum Color Options

9016

Beyaz
White



Eloksoal Boyalı
Anodized Painted



Bronz Boyalı
Bronze Painted

8003

Altın Meşe
Golden Oak

8016

Maun
Mahogany

7016

Antrasit Gri
Anthracite Gray

SÜPER SERİ PLİSE SİNEKLİK / SUPER SERIES PLEATED FLY SCREEN

Köşeden Gergi

Corner Tensioner



İçten Gergi Set İçeriği / Internal Tensioner Set Contents

No	ÜRÜN KODU Product Code	ÜRÜN ADI Product Name
1	316	Süper Kasa Profili Super Case Profile
2	320	Süper Kanat Profili Super Wing Profile
3	-	Köşe Birleştirme Corner Wedge
4	-	Rulman Takımı Bearing Set
5	PLS 11	Delikli Klips Hole Clip
6	PLS 05	Plise Şerit Pleat Ribbon
7	PLS 04	Plise Tül Pleat Tulle

Kapı ve pencereler için tasarlanmış özel bir modeldir. Montajı, panjur ile kapı-pencere pervazı arasındaki boşluğa kolayca yapılabilir.

Bu ürün, panjurlu kapı ve pencerelerde de sineklik kullanımını mümkün kılar.

It is a specially designed model for doors and windows with shutters. It can be easily installed in the space between the shutter and the door-window frame.

This product allows the use of insect screens on doors and windows with shutters.

AKS 11
AKS 12

Beyaz / White
Siyah / Black



Süper Seri Köşeden Gergi Aksesuar Seti
Super Serie Corner Tensioner Accessory Set

Koli İçi Adet
Amount within parcel

100 Set

AKS 24
AKS 25

Beyaz / White
Siyah / Black



Süper Büyük Seri Köşeden Gergi Aksesuar Seti
Super Big Serie Corner Tensioner Accessory Set

Koli İçi Adet
Amount within parcel

100 Set

316



Süper Kasa Profil
Super Case Profile

Paket İçi Adet
Amount within package

10

Gramajı
Weight

0,248 kg/m

320



Süper Kanat Profil
Super Wing profile

Paket İçi Adet
Amount within package

10

Gramajı
Weight

0,303 kg/m

325



Süper Büyük Kasa Profil
Super Big Case Profile

Paket İçi Adet
Amount within package

4

Gramajı
Weight

0,469 kg/m

Alüminyum Renk Seçeneği

Aluminum Color Options

9016

Beyaz
White



Eloksal Boyalı
Anodized Painted



Bronz Boyalı
Bronze Painted

8003

Altın Meşe
Golden Oak

8016

Maun
Mahogany

7016

Antrasit Gri
Anthracite Gray

NOBEL SERİ PLİSE SİNEKLİK / NOBEL SERIES PLEATED FLY SCREEN

Köşeden Gergi

Corner Tensioner

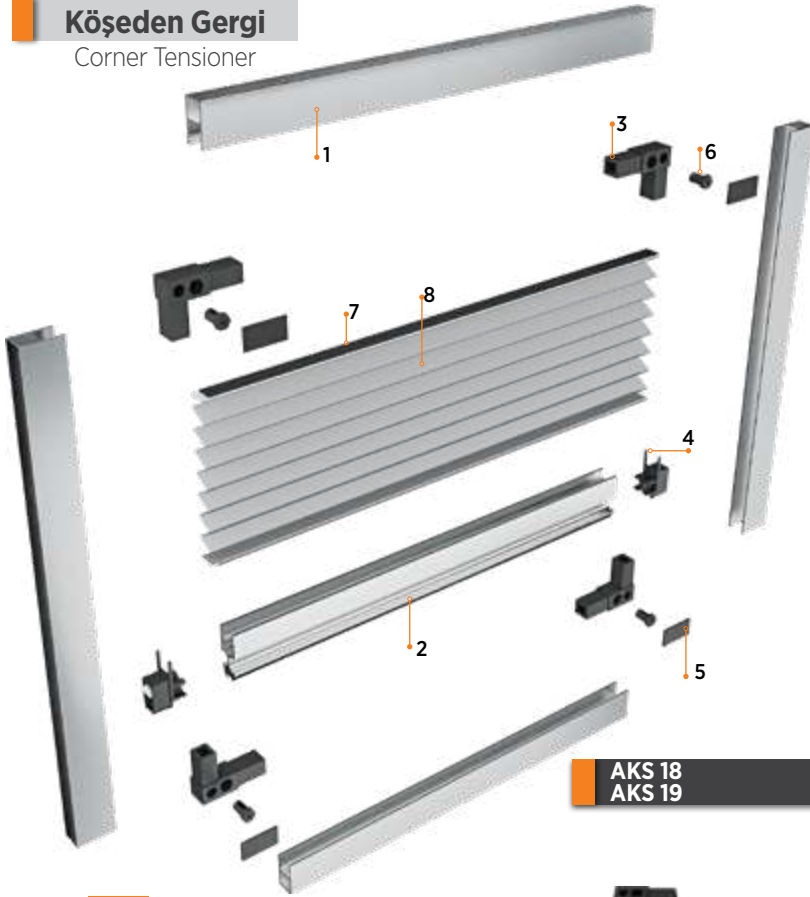

Yeni Ürün New Product

Köşeden Gergi Set İçeriği / Corner Tensioner Set Contents

No	ÜRÜN KODU Product Code	ÜRÜN ADI Product Name
1	338	Nobel Kasa Profili Nobel Case Profile
2	335	Nobel Kanat Profili Nobel Wing Profile
3	-	Nobel Köşe Takoza Nobel Corner Wedge
4	-	Nobel Rulman Takımı Nobel Bearing Set
5	-	Nobel Köşe Takoza Kapağı Nobel Corner Wedge Lid
6	-	Nobel Köşe Takoza Pimi Nobel Corner Wedge Pin
7	-	Plise Şerit Pleat Ribbon
8	-	Plise Tül Pleat Tulle

Özellikle panjur ve karavan gibi dar alanlarda tercih edilen bir sistemdir. Kasa genişliği diğer serilere göre daha küçüktür. Bu ürünle birlikte panjur sistemlerinde kullanım imkânı sağlayan slim seriye alternatif olarak değerlendirilmektedir.

It is a preferred system, especially in narrow areas such as blinds and caravans. The case width is smaller than other series. With this product, it is considered an alternative to the slim series, which provides the opportunity to be used in shutter systems.

AKS 18
AKS 19

Beyaz / White
Siyah / Black



Nobel Köşeden Gergi Aksesuar Seti
Nobel Corner Tensioner Accessory Set

Koli İçi Adet
Amount within parcel

100 Set

AKS 22
AKS 23

Beyaz / White
Siyah / Black

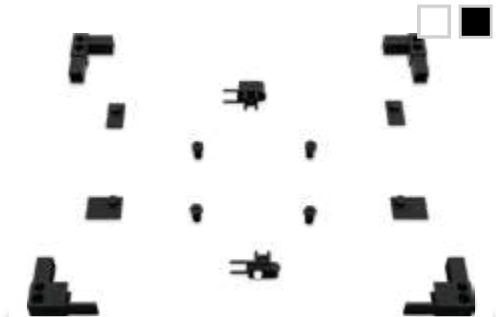

Nobel Köşeden Gergi Eşiksiz Aksesuar Seti

Nobel Corner Tensioner Accessory Set without Threshold

Koli İçi Adet
Amount within parcel

100 Set

335



Nobel Kanat Profili
Nobel Wing Profile

Paket İçi Adet
Amount within package

10

Gramajı
Weight

0,345 kg/m

336



Nobel Eşiksiz Kasa Profili
Nobel Case Profile without Threshold

Paket İçi Adet
Amount within package

10

Gramajı
Weight

0,148 kg/m

338



Nobel Kasa Profili
Nobel Case Profile

Paket İçi Adet
Amount within package

10

Gramajı
Weight

0,250 kg/m

Alüminyum Renk Seçeneği

Aluminum Color Options

9016

Beyaz
White



Eloksal Boyalı
Anodized Painted



Bronz Boyalı
Bronze Painted

8003

Altın Meşe
Golden Oak

8016

Maun
Mahogany

7016

Antrasit Gri
Anthracite Gray

NOBEL SERİ PLİSE SİNEKLİK / NOBEL SERIES PLEATED FLY SCREEN

İçten Montajlı Internal Mounted

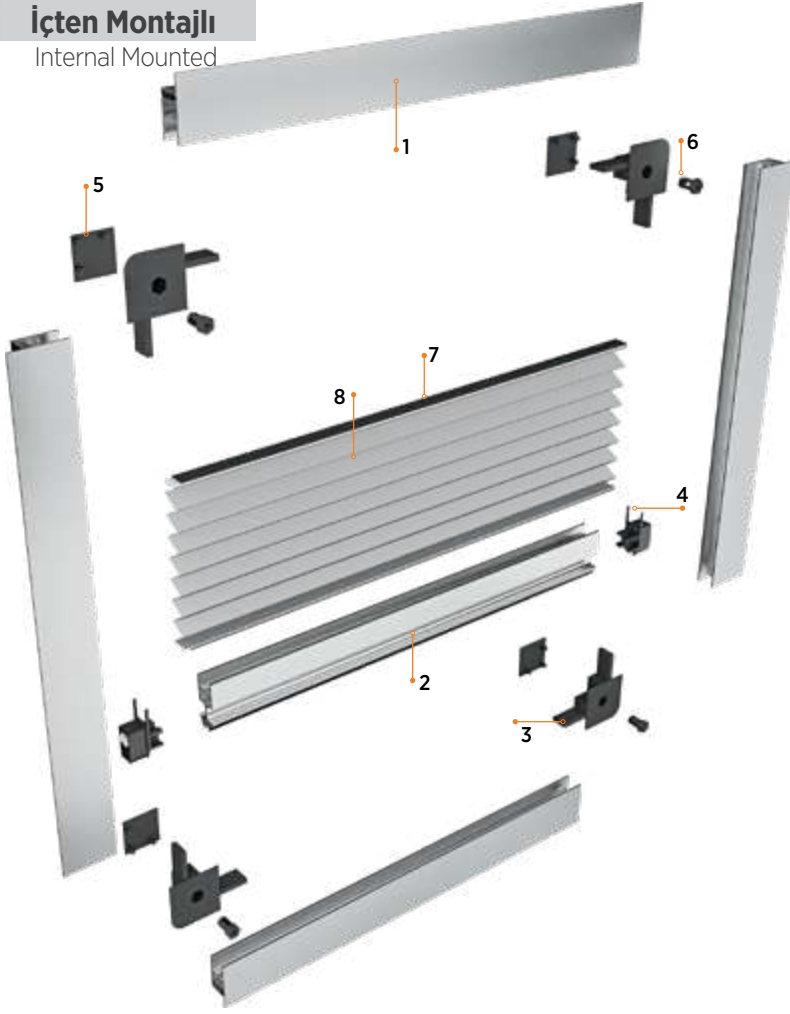

Yeni Ürün New Product

İçten Montaj Set İçeriği / Internal Mounted Set Contents

No	ÜRÜN KODU Product Code	ÜRÜN ADI Product Name
1	337	Nobel İçten Montajlı Kasa Nobel Internal Mounted Case Profile
2	335	Nobel Kanat Profili Nobel Wing
3	-	Nobel İçten Montajlı Köşe Takoza Nobel Internally Assembled Corner Wedge
4	-	Nobel Rulman Takımı Nobel Bearing Set
5	-	Nobel İçten Montajlı Köşe Takoza Kapağı Nobel Internal Mounted Corner Wedge Lid
6	-	Nobel Köşe Takoza Pimi Nobel Corner Wedge Pin
7	-	Plise Şerit Pleat Ribbon
8	-	Plise Tül Pleat Tulle

PLS 06



Nobel Seri Metal Klips Nobel Serial Metal Cleps

Paket İçi Adet Amount within package	500	Koli İçi Adet Amount within parcel	500
---	-----	---------------------------------------	-----

Montaj alanı dar olan Pvc ve panjur sistemleri için kullanılmaktadır. Sistem içerisinde kolay ve hızlı bir şekilde montajlanabilmektedir. İhtiyaç halinde sökülüp takılabileme imkanı sunar.

It is used for PVC and shutter systems with narrow mounting areas. It can be assembled easily and quickly from within the system. It offers the possibility to be disassembled and mounted when needed.



335	
Nobel Kanat Profil Nobel Wing Profile	
Paket İçi Adet Amount within package	10
Gramajı Weight	0,345 kg/m



337	
Nobel İçten Montajlı Kasa Profil Nobel Internal Mounted Case Profile	
Paket İçi Adet Amount within package	10
Gramajı Weight	0,338 kg/m



AKS 20 AKS 21	Beyaz / White Siyah / Black
Nobel İçten Montajlı Aksesuar Seti Nobel Internal Mounted Accessory Set	
Koli İçi Adet Amount within parcel	100 Set

Alüminyum Renk Seçeneği Aluminum Color Options

9016

Beyaz
White



Eloksoal Boyalı
Anodized Painted



Bronz Boyalı
Bronze Painted

8003

Altın Meşe
Golden Oak

8016

Maun
Mahogany

7016

Antrasit Gri
Anthracite Gray

SLIM SERİ İÇTEN MONTAJLI PLİSE SİNEKLİK / SLIM SERIES INTERNAL MOUNTED PLAIT FLY SCREEN



Slim İçten Geçmeli Sineklik Profil
Slim Internal Mounted Fly Screen Profile

Paket İçi Adet Amount within package	10	Gramajı Weight	0,272 kg/m
---	----	-------------------	------------



Slim Kanat Profil
Slim Wing profile

Paket İçi Adet Amount within package	10	Gramajı Weight	0,303 kg/m
---	----	-------------------	------------



İçten Montajlı Metal Klips
Internal Mounted Metal Clip

Paket İçi Adet Amount within package	500	Koli İçi Adet Amount within parcel	500
---	-----	---------------------------------------	-----



İçten Montajlı Plise Köşeden Gergi Aksesuar Seti
Internal Mounted Pleated Corner Tensioner Accessory Set

Koli İçi Adet Amount within parcel	100 Set
---------------------------------------	---------

Aksesuar İçeriği / Accessory Contents

No	ÜRÜN KODU Product Code	ÜRÜN ADI Product Name
1	-	4 adet Köşe Takoza 4 Pieces Corner Wedge
2	-	2 Adet Rulmanlı Hareket Kapağı 2 Pieces Ball Bearing
3	-	2 Adet Köşe Gergi Vidası 2 Pieces Corner Screw
4	-	10 Adet İp Dağıtım Aparatı (Delikli Klips) 10 Pieces Rope Distribution Apparatus (Hole Clip)

ÖZELLİKLER
PROPERTIES

İçten Takılabilen Plise Sineklik;
Internal Mountable Pleated Flyscreen;

Pencere önünde engel olan yerlerde (korkuluk, panjur, çiçeklik, vb.) kullanılır.

Used in areas where there are obstacles in front of windows (railings, window shades, flower beds, etc.).

Yüksek katlarda sinekliğin dışarı açılmasını istemediğiniz durumlarda,

In cases where you don't want the fly screen to be opened on higher floors to the exterior,

Montaj için pencere kasasına herhangi bir vida atılmasını istemediğiniz durumlarda,

If you don't want any screws to be inserted into the window frame for installation,

Bütün olumsuzlukları ortadan kaldıran sineklik sistemidir.

It is a flyscreen systems which eliminates all the problems.

İçten takılabilen sineklik, sabit sineklik olarak vazife görür.

The flyscreens which can be fitted from the inside, serve as fixed flyscreen.

Klips ile takıldığı için montajda vida kullanılmaz. Montajı çok kolaydır.

Screw is not used in the assembly since it is attached with the clip. It is very easy to assemble.

Kolayca sökülerek temizliği yapılabilir.

It can be easily removed and cleaned.



Alüminyum Renk Seçeneği

Aluminum Color Options

9016

Beyaz
White



Eloksal Boyalı
Anodized Painted



Bronz Boyalı
Bronze Painted

8003

Altın Meşe
Golden Oak

8016

Maun
Mahogany

7016

Antrasit Gri
Anthracite Gray

İÇTEN MONTAJLI SABİT SİNEKLİK / INTERNAL MOUNTED FIXED FLY SCREEN



Kasa Profil Case Profile			
Paket İçi Adet Amount within package	10	Gramajı Weight	0,256 kg/m



Köşe Birleştirici Takoz Corner Combiner Wedge			
Paket İçi Adet Amount within package	100	Koli İçi Adet Amount within parcel	500



İçten Montajlı Metal Klips Internal Mounted Metal Clip			
Paket İçi Adet Amount within package	500	Koli İçi Adet Amount within parcel	500

ÖZELLİKLER PROPERTIES



İçten Takılabilen Sineklik; Internal Mountable Flyscreen;

Pencere önünde engel olan yerlerde (korkuluk, panjur, çiçeklik, vb.) kullanılır.
Used in areas where there are obstacles in front of windows (railings, window shades, flower beds, etc.).

Yüksek katlarda sinekliğin dışarı açılmasını istemediğiniz durumlarda,
In cases where you don't want the fly screen to be opened on higher floors to the exterior,

Montaj için pencere kasasına herhangi bir vida atılmasını istemediğiniz durumlarda,
If you don't want any screws to be inserted into the window frame for installation,

Bütün olumsuzlukları ortadan kaldıran sineklik sistemidir.
It is a flyscreen systems which eliminates all the problems.

İçten takılabilen sineklik, sabit sineklik olarak vazife görür.
The flyscreens which can be fitted from the inside, serve as fixed flyscreen.

Klips ile takıldığı için montajda vida kullanılmaz. Montajı çok kolaydır.

Screw is not used in the assembly since it is attached with the clip. It is very easy to assemble.

Kolayca sökülerek temizliği yapılabilir.
It can be easily removed and cleaned.

Alüminyum Renk Seçeneği Aluminum Color Options

9016

Beyaz
White



Eloksal Boyalı
Anodized Painted



Bronz Boyalı
Bronze Painted

8003

Altın Meşe
Golden Oak

8016

Maun
Mahogany

7016

Antrasit Gri
Anthracite Gray

ÜRÜN ADI Product Name	ÜRÜN KODU Product Code	Paket m ² Package m ²	KOLİ İÇİ ADET (m ²) Amount within Parcel (m ²)
200cm Plise Polyester Tül 200cm Plait Polyester Tulle	200 P	60 m ²	300 m ²
210cm Plise Polyester Tül 210cm Plait Polyester Tulle	210 P	63 m ²	315 m ²
220cm Plise Polyester Tül 220cm Plait Polyester Tulle	220 P	66 m ²	330 m ²
240cm Plise Polyester Tül 240cm Plait Polyester Tulle	240 P	72 m ²	360 m ²
270cm Plise Polyester Tül 270cm Plait Polyester Tulle	270 P	81 m ²	405 m ²
300cm Plise Polyester Tül 300cm Plait Polyester Tulle	300 P	90 m ²	450 m ²



Pile yüksekliği: 14 mm, 16 mm ve 19 mm ölçülerinde stoklarımızda mevcuttur.

A ve B kalitede satışa sunulmaktadır.

Plait height: Available in stock in sizes of 14 mm, 16 mm, and 19 mm.

Available for sale in A and B quality.

PLS 12



Plise İpi

Pleat Yarn

Paket İçi Adet Amount within package	1 Top * 500 m	Koli İçi Adet Amount within parcel	12
---	---------------	---------------------------------------	----

PLS 52



PVC Bantlı Şerit 12 mm

PVC Taped Stripe 12 mm

Paket İçi Adet Amount within package	1 Top * 500 m	Koli İçi Adet Amount within parcel	10
---	---------------	---------------------------------------	----

PLS 50



PVC Bantlı Şerit 16 mm

PVC Taped Stripe 16 mm

Paket İçi Adet Amount within package	1 Top * 500 m	Koli İçi Adet Amount within parcel	10
---	---------------	---------------------------------------	----

PLS 51



PVC Bantlı Şerit 19 mm

PVC Taped Stripe 19 mm

Paket İçi Adet Amount within package	1 Top * 500 m	Koli İçi Adet Amount within parcel	10
---	---------------	---------------------------------------	----

PLS 14-A



PVC Yeşil Şerit 16mm

PVC Green Stripe 16mm

Paket İçi Adet Amount within package	1 Top * 1.400 m
---	-----------------

PLS 14-B



PVC Yeşil Şerit 19mm

PVC Green Stripe 19mm

Paket İçi Adet Amount within package	1 Top * 1.000 m
---	-----------------

PLS 14



PVC Siyah Şerit

PVC Black Stripe

Paket İçi Adet Amount within package	1 Top * 100 m	Koli İçi Adet Amount within parcel	10
---	---------------	---------------------------------------	----

PLS 53



Çift Taraflı Bant

Double Sided Band

Paket İçi Adet Amount within package	1 Top * 50 m	Koli İçi Adet Amount within parcel	10
---	--------------	---------------------------------------	----

PLS 22



Mıknatıs

Magnet

Paket İçi Adet Amount within package	16 kg	Koli İçi Adet Amount within parcel	≈175 m
---	-------	---------------------------------------	--------

PRD 08



Kuş Gözü (Metal) 4 mm

Rivet (Metal) 4 mm

Koli İçi Adet Amount within parcel	5.000
---------------------------------------	-------

PLS 11



Kuş Gözü (Metal) - 5 mm

Rivet (Metal) - 5 mm

Koli İçi Adet Amount within parcel	5.000
---------------------------------------	-------

PRD 31



Kumaş Delme Makinesi

Fabric Punching Machine

PLATİN SÜRME SİNEKLİK / PLATIN SLIDING FLY SCREEN



Platin Set İçeriği / Platin Set Contents

No	ÜRÜN KODU Product Code	ÜRÜN ADI Product Name
1	321/322	Kasa Profil Case Profile
2	-	Plastik Köşe Takozu Plastic Corner Wedge
3	-	Denge Plastiği Balance Plastic
4	-	Rulmanlı Teker Bearing Wheel
5	-	Alüminyum Köşe Takozu Aluminum Corner Wedge
6	323	Kanat Profil Wing Profile
7	-	Sineklik Tülü Flynet Tulle

Platin Sürme Sineklik, açılan kapının yanında sabit panele sahip kapı modelleri için idealdir. Verandaların açık alanlarını çepeçevre kapatarak konforlu bir kullanım sağlar. Ayrıca katlanır cam balkon sistemlerinde uygulanabilmektedir. Çerçevesiz sineklik paneli alt ve üst raylarda çalışmaktadır. Sistemin alt ve üst rayları tek panel ve iki panele uygun olarak tekli ve çiftli ray şeklinde tasarlanmıştır. Bu sistemde bir sineklik paneli max. 200 cm genişlik ve max. 250 cm yükseklikte tavsiye edilmektedir.

Platin Sliding Fly Screen is ideal for door models with fixed panels next to the opening door. It provides comfortable use by covering the open areas of the verandas all around. It can also be applied in folding glass balcony systems. Framed fly screen panel works on the lower and upper rails. The lower and upper rails of the system are designed as single and double rails in accordance with single panels and two panels. In this system, a mosquito net panel is recommended with a max. width of 200 cm and a max. height of 250 cm.



Platin Serie Aksesuar Seti
Platin Serie Accessory Set

Koli İçi Adet
Amount within parcel

50 Set



Platin Sürme Sineklik Tekli Kasa
Platin Single Case

Paket İçi Adet
Amount within package

8

Gramajı
Weight

0,352 kg/m



Platin Çiftli Kasa
Platin Double Case

Paket İçi Adet
Amount within package

6

Gramajı
Weight

0,455 kg/m



Platin Sürme Sineklik Kanat Profil
Platin Wing Profile

Paket İçi Adet
Amount within package

10

Gramajı
Weight

0,506 kg/m

Alüminyum Renk Seçeneği

Aluminum Color Options

9016

Beyaz
White



Eloksoal Boyalı
Anodized Painted



Bronz Boyalı
Bronze Painted

8003

Altın Meşe
Golden Oak

8016

Maun
Mahogany

7016

Antrasit Gri
Anthracite Gray

AYKİM SÜRME SİNEKLİK / AYKİM SLIDING FLY SCREEN

PRS 37

Beyaz / Altın Meşe / Siyah
White / Golden oak / Black



Aykim Makarasız Köşe
Aykim Corner whitout Roll

Paket İçi Adet Amount within package	50	Koli İçi Adet Amount within parcel	500
---	----	---------------------------------------	-----

PRS 36

Beyaz / Altın Meşe / Siyah
White / Golden oak / Black



Aykim Makaralı Köşe
Aykim Corner whit Roll

Paket İçi Adet Amount within package	50	Koli İçi Adet Amount within parcel	500
---	----	---------------------------------------	-----

PRS 38

Beyaz / Altın Meşe / Siyah
White / Golden oak / Black



Aykim Kasa Takozu
Aykim Wedge

Paket İçi Adet Amount within package	100	Koli İçi Adet Amount within parcel	1.000
---	-----	---------------------------------------	-------

309



Aykim Kasa Profil
Aykim Case Profile

Paket İçi Adet Amount within package	8	Gramajı Weight	0,374 kg/m
---	---	-------------------	------------

310



Aykim Kanat Profil
Aykim Wing profile

Paket İçi Adet Amount within package	10	Gramajı Weight	0,315 kg/m
---	----	-------------------	------------



Alüminyum Renk Seçeneği

Aluminum Color Options

9016

Beyaz
White



Eloksoal Boyalı
Anodized Painted



Bronz Boyalı
Bronze Painted

8003

Altın Meşe
Golden Oak

8016

Maun
Mahogany

7016

Antrasit Gri
Anthracite Gray



Stor Set içeriği / Stor Set Contents

No	ÜRÜN KODU Product Code	ÜRÜN ADI Product Name
1	409	Üst Kasa Profil Upper Case Profile
2	410	Yan Kasa Profil Side Case Profile
3	411	Alt Kasa Profil Bottom Case Profile
4	407	Kanat Profil Wing Profile
5	408	Tül Boru Profil Tulle Pipe Profile
6	-	Stor Tül Stor Tulle
7	-	Fren Köşe Plastiği Brake Corner Plastic
8	-	Yay Köşe Plastiği Spring Corner Plastic
9	-	Yay Spring
10	-	Yay Kapama Boru Plastiği Spring Closure Pipe Plastic
11	-	Yay Sabitleme Plastiği Spring Fixing Plastic
12	-	Kasa Birleştirme Plastiği Case Joining Plastic
13	-	Kulp Handle
14	-	İp Tutma Aparatı Rope Holder
15	-	Kanat Kapağı Wing Cover
16	-	Fren Sistemi Brake System
17	-	Kıl FİTİL Hair Seal



STR 01

Beyaz / Siyah
White / Black



Stor Sineklik Aksesuar Seti
Stor Fly Screen Accessory Set

Paket İçi Adet Amount within package	1 Set	Koli İçi Adet Amount within parcel	50 Set
---	-------	---------------------------------------	--------

STR 02

Siyah
Black



Stor Sineklik Fren Sistemi
Stor Fly Screen Pipe Profile

Paket İçi Adet Amount within package	50	Koli İçi Adet Amount within parcel	50
---	----	---------------------------------------	----

Fitul 22



67x650 Kıl Fitol
67x650 Weatherstrips

Paket İçi Adet Amount within package	350 m	Koli İçi Adet Amount within parcel	1400 m
---	-------	---------------------------------------	--------

STR 03



Stor Kaset 160 cm
Cassette 160 cm

Paket İçi Adet Amount within package	1 Set		
---	-------	--	--

STR 04



Stor Kaset 240 cm
Cassette 240 cm

Paket İçi Adet Amount within package	1 Set		
---	-------	--	--

410



Stor Sineklik Yan Kasa Profil
Stor Fly Screen Side Case Profile

Paket İçi Adet Amount within package	6	Gramajı Weight	0,413 kg/m
---	---	-------------------	------------

411



Stor Sineklik Alt Kasa Profil
Stor Fly Screen Bottom Case Profile

Paket İçi Adet Amount within package	10	Gramajı Weight	0,318 kg/m
---	----	-------------------	------------



- Yay mekanizmalı ve geri sarmalı olarak tasarlandı.
- Alt kasa aynı zamanda sineklik ekranını kilitleyecek şekilde tırnaklı olarak tasarlandı.
- ALüminyum kanat alt kasa tırnaklarından ayrıldığı anda sarım profili içerisindeki kurulmuş olan yay, sineklik tülünü üst kasa içerisinde geri sarım yaparak toplar. Bu toplama esnasında hidrolik fren devreye girer. Böylece sarım yavaş ve düzgün olur.
- Sinekliğin çerçevesini oluşturan profiller aynı zamanda kasa profili olarak dizayn edildi. Üst kasa, yan kasa ve alt kasa profilleri 4 adet takoz ile birleştirildi.
- Sistem kurulur. Köşe takozlarındaki kanallardan yapılan vidalama ile sistem yerine montajlanır. İşte bu kadar basit!

- It is designed with a spring mechanism and rewind.
- The bottom case is also designed with tabs to lock the fly screen.
- As soon as the aluminum wing is separated from the lower case tabs, the spring installed in the winding profile collects the fly net in the upper case by rewinding. During this collection, the hydraulic brake is activated. Thus, the winding is slow and smooth.
- The profiles forming the frame of the fly screen were also designed as frame profiles. Upper case, side case, and lower case profiles were combined with 4 wedges.
- The system is easily installed. The installation is accomplished by screwing through the channels in the corner wedges. That's all it takes!

Alüminyum Renk Seçeneği

Aluminum Color Options

9016

Beyaz
White



Eloksal Boyalı
Anodized Painted



Bronz Boyalı
Bronze Painted

8003

Altın Meşe
Golden Oak

8016

Maun
Mahogany

7016

Antrasit Gri
Anthracite Gray



Ahşap
Wooden

PRS 01



17x25 Sineklik Köşe Takozu
17x25 Flynet Corner Wedge

Paket İçi Adet Amount within package	100	Koli İçi Adet Amount within parcel	1.000
---	-----	---------------------------------------	-------

PRS 02



17x25 Sineklik Mentеше (Plastik Pimli)
17x25 Flynet Plastic Hinge (with Plastic Pin)

Paket İçi Adet Amount within package	100	Koli İçi Adet Amount within parcel	2.000
---	-----	---------------------------------------	-------

PRS 04



17x25 Sineklik Tutamak
17x25 Flynet Handle

Paket İçi Adet Amount within package	100	Koli İçi Adet Amount within parcel	1.500
---	-----	---------------------------------------	-------

PRS 05



17x25 Sineklik Çıtçı
17x25 Flynet Gripper

Paket İçi Adet Amount within package	100	Koli İçi Adet Amount within parcel	2.000
---	-----	---------------------------------------	-------

PRS 06



17x25 Sineklik Bağlama Pabucu
17x25 Flynet Fastening Plate

Paket İçi Adet Amount within package	50	Koli İçi Adet Amount within parcel	500
---	----	---------------------------------------	-----

PRS 07



10x20 Sineklik Köşe Takozu
10x20 Flynet Corner Wedge

Paket İçi Adet Amount within package	100	Koli İçi Adet Amount within parcel	2.500
---	-----	---------------------------------------	-------

PRS 08



10x20 Sineklik Mentеше (Plastik Pimli)
10x20 Flynet Plastic Hinge (with Plastic Pin)

Paket İçi Adet Amount within package	100	Koli İçi Adet Amount within parcel	2.000
---	-----	---------------------------------------	-------

PRS 10



10x20 Sineklik Tutamak
10x20 Flynet Handle

Paket İçi Adet Amount within package	100	Koli İçi Adet Amount within parcel	3.000
---	-----	---------------------------------------	-------

PRS 11



10x20 Sineklik Çıtçı
10x20 Flynet Gripper

Paket İçi Adet Amount within package	100	Koli İçi Adet Amount within parcel	3.000
---	-----	---------------------------------------	-------

PRS 12

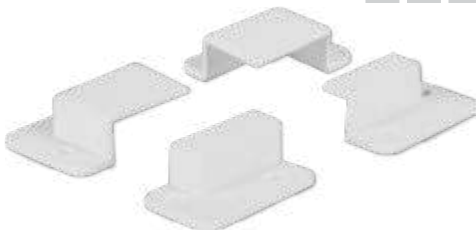

10x20 Sineklik Bağlama Pabucu
10x20 Flynet Fastening Plate

Paket İçi Adet Amount within package	50	Koli İçi Adet Amount within parcel	500
---	----	---------------------------------------	-----

PRS 13



10x20 Sineklik Tutma Halkası
10x20 Flynet Holding Ring

Paket İçi Adet Amount within package	100	Koli İçi Adet Amount within parcel	2.500
---	-----	---------------------------------------	-------

PRS 14



10x20 Sineklik Tutma Halkası Altı
10x20 Flynet Holding Ring Bottom Part

Paket İçi Adet Amount within package	100	Koli İçi Adet Amount within parcel	2.500
---	-----	---------------------------------------	-------

PRS 15



20x40 Sineklik Köşe Takozu
20x40 Flynet Corner Wedge

Paket İçi Adet Amount within package	50	Koli İçi Adet Amount within parcel	600
---	----	---------------------------------------	-----

PRS 16



10x20 Sineklik Köşe Takozu 45°
10x20 Flynet Corner Wedge 45°

Paket İçi Adet Amount within package	100	Koli İçi Adet Amount within parcel	2.000
---	-----	---------------------------------------	-------

PRS 17



17x25 Sineklik Köşe Takozu 45°
17x25 Flynet Corner Wedge 45°

Paket İçi Adet Amount within package	100	Koli İçi Adet Amount within parcel	600
---	-----	---------------------------------------	-----

PRS 26



Sineklik Köşe Mukavemet Takozu
Flynet Corner Strength Wedge

Paket İçi Adet Amount within package	100	Koli İçi Adet Amount within parcel	1.500
---	-----	---------------------------------------	-------

PRS 24



Plastik "D" Kol
Plastic "D" Handle

Paket İçi Adet Amount within package	50	Koli İçi Adet Amount within parcel	600
---	----	---------------------------------------	-----

PRS 30



Plastik "C" Kol
Plastic "C" Handle

Paket İçi Adet Amount within package	100	Koli İçi Adet Amount within parcel	1.500
---	-----	---------------------------------------	-------

PRS 27

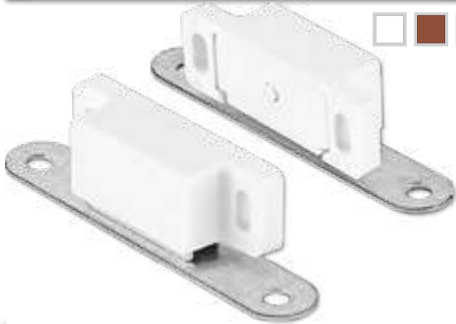

Mıknatıslı Çıtçı
Gripper with Magnet

Paket İçi Adet Amount within package	100	Koli İçi Adet Amount within parcel	500
---	-----	---------------------------------------	-----

PRS 19



Sineklik Fıtılı (Beyaz)
Flynet Seal (White)

Paket İçi Adet Amount within package	15	Koli İçi Adet Amount within parcel	1.500 m
---	----	---------------------------------------	---------

PRS 29



Sineklik Takma Aparatı 3'lü
Triple Flynet Mounting Apparatus

Paket İçi Adet Amount within package	20	Koli İçi Adet Amount within parcel	100
---	----	---------------------------------------	-----

PRS 37



Aykim Makarasız Köşe
Aykim Corner without Pulley

Paket İçi Adet Amount within package	50	Koli İçi Adet Amount within parcel	500
---	----	---------------------------------------	-----

PRS 36



Aykim Makaralı Köşe
Aykim Corner with Pulley

Paket İçi Adet Amount within package	50	Koli İçi Adet Amount within parcel	500
---	----	---------------------------------------	-----

PRS 38



Aykim Kasa Takozu
Aykim Wedge

Paket İçi Adet Amount within package	100	Koli İçi Adet Amount within parcel	1.000
---	-----	---------------------------------------	-------

PRS 25



Cam Küreği
Glass Showed

Koli İçi Adet
Amount within parcel 150

PRS 20



Plastik Çarpma
Plastic Crash Barrier

Koli İçi Adet
Amount within parcel 500

ZZ 29



Emniyet Kilidi
Safety Lock

Koli İçi Adet
Amount within parcel 150

ZZ 32



Pimli Emniyet Kilidi
Safety Lock with Pin

Koli İçi Adet
Amount within parcel 150

ZZ 39



Halatlı Emniyet Kilidi
Safety Lock with Rope

Koli İçi Adet
Amount within parcel 100

PSS 8



Paslanmaz Lüks Teker
Stainless Luxury Wheel

Koli İçi Adet
Amount within parcel 200

ZZ 26



Teflon Bant
Teflon Tape

Koli İçi Adet
Amount within parcel 50 m

Cam Takozları

Glass Wedges



ÜRÜN ADI
Product Name

ÜRÜN KODU
Product Code

KOLİ İÇİ ADET
Amount within Parcel

İnce Cam Takozu (2mmx20mmx80mm) / Thin Glass Wedge

ACT 6

20.000

Kalın Cam Takozu (Kırılan) (5mmx20mmx80mm) / Thick Glass Wedge Broken One

ACT 7

12.000

Kalın Cam Takozu (Bükülen) (5mmx20mmx80mm) / Thick Glass Wedge Bending

ACT 8

12.000

6000 Cam Takozu Kalın (5mmx25mmx80mm) / Thick Glass Wedge

ACT 9

10.000

Geniş Cam Takozu Kalın (5mmx28mmx80mm) / Wide Glass Wedge Thick

ACT 10

10.000

32'lik Cam Takozu Kalın (5mmx32mmx80mm) / Glass Wedge for Size 32 Thick

ACT 11

5.000

DESTEK SACLI 90 mm PLASTİK KAPI MENTEŞESİ

90 mm Plastic Door Hinge with Support Sheet

ÜRÜN ADI Product Name	ÜRÜN KODU Product Code	KOLI İÇİ ADET Amount within Parcel
Beyaz 9016 / White 9016	SM 90 9016	150
Altın Meşe 8003 / Golden Oak 8003	SM 90 8003	150
Maun 8016 / Mahogany 8016	SM 90 8016	150
Antrasit Gri 7016 / Anthracite Gray 7016	SM 90 7016	150
Siyah 9005 / Black 9005	SM 90 9005	150



ÖZELLİKLER

PROPERTIES

1,2 mm galvaniz kaplamalı çelik sac ile desteklenmiştir.
Supported by 1,2 mm galvanized steel sheet.

İç yapısındaki sac desteği sayesinde zamak menteşelere göre taşıma kapasitesi daha yüksektir.
Thanks to the sheet metal support in the internal structure higher carrying capacity is given compared to the zamak hinges.

Kanatlarda sarkma problemini tamamen ortadan kaldırır.
It completely eliminates the problem of sagging in the wings.



1,2 mm galvaniz kaplamalı
çelik sac (90 mm)

1,2 mm galvanized
steel sheet (90 mm)



DESTEK SACLI 75 mm PLASTİK PENCERE MENTEŞESİ

75 mm Plastic Window Hinge with Support Sheet

ÜRÜN ADI Product Name	ÜRÜN KODU Product Code	KOLI İÇİ ADET Amount within Parcel
Beyaz 9016 / White 9016	SM 75 9016	150
Altın Meşe 8003 / Golden Oak 8003	SM 75 8003	150
Maun 8016 / Mahogany 8016	SM 75 8016	150
Antrasit Gri 7016 / Anthracite Gray 7016	SM 75 7016	150
Siyah 9005 / Black 9005	SM 75 9005	150



ÖZELLİKLER

PROPERTIES

1,2 mm galvaniz kaplamalı çelik sac ile desteklenmiştir.
Supported by 1,2 mm galvanized steel sheet.

İç yapısındaki sac desteği sayesinde zamak menteşelere göre taşıma kapasitesi daha yüksektir.
Thanks to the sheet metal support in the internal structure higher carrying capacity is given compared to the zamak hinges.

Kanatlarda sarkma problemini tamamen ortadan kaldırır.
It completely eliminates the problem of sagging in the wings.



1,2 mm galvaniz kaplamalı
çelik sac (75 mm)

1,2 mm galvanized
steel sheet (75 mm)



Gold Baza Profil
Gold Base Profile

Paket İçi Adet Amount within package	3	Gramajı Weight	0,717 kg/m
---	---	-------------------	------------

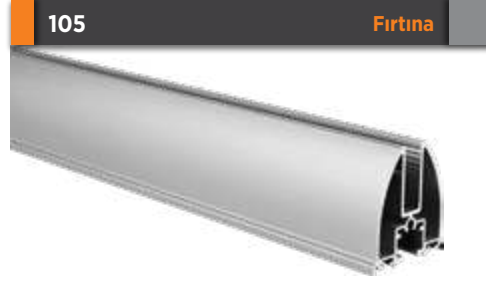

Firtına Baza Profil
Firtına Base Profile

Paket İçi Adet Amount within package	3	Gramajı Weight	0,730 kg/m
---	---	-------------------	------------



Oluklu Kasa Profil
Corrugated Case Profile

Paket İçi Adet Amount within package	3	Gramajı Weight	1,396 kg/m
---	---	-------------------	------------



Düz Kasa Profil
Flat Case Profile

Paket İçi Adet Amount within package	3	Gramajı Weight	1,355 kg/m
---	---	-------------------	------------



Oluklu Büyük Kasa Profil
Corrugated Big Case Profile

Paket İçi Adet Amount within package	3	Gramajı Weight	1,611 kg/m
---	---	-------------------	------------



Büyük Düz Kasa Profil
Big Flat Case Profile

Paket İçi Adet Amount within package	3	Gramajı Weight	1,570 kg/m
---	---	-------------------	------------



Dar Yan Dikme Profil
Thin Side Column Profile

Paket İçi Adet Amount within package	6	Gramajı Weight	0,441 kg/m
---	---	-------------------	------------



Geniş Yan Dikme Profil
Thick Side Column Profile

Paket İçi Adet Amount within package	6	Gramajı Weight	0,457 kg/m
---	---	-------------------	------------



Stor Profil
Stor Profile

Paket İçi Adet Amount within package	2	Gramajı Weight	1,062 kg/m
---	---	-------------------	------------



8 mm İspanyolet Profil
8 mm Espagnolette Profile

Paket İçi Adet Amount within package	6	Gramajı Weight	0,517 kg/m
---	---	-------------------	------------



8 mm İspanyolet Profil Karşılığı
8 mm Espagnolette Combination Profile

Paket İçi Adet Amount within package	6	Gramajı Weight	0,343 kg/m
---	---	-------------------	------------

8mm CAM BALKON FITİL PROFİLLERİ

8mm Balcony Wick Profiles



Büyük D Fitol
Big D Wick

Paket İçi Adet Amount within package	10	Gramajı Weight	0,247 kg/m
---	----	-------------------	------------



Küçük D Fitol
Small D Wick

Paket İçi Adet Amount within package	10	Gramajı Weight	0,167 kg/m
---	----	-------------------	------------

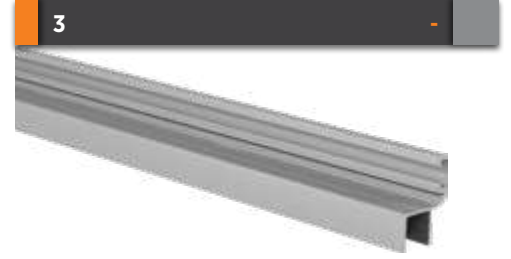

Küçük h Fitol
Small h Wick

Paket İçi Adet Amount within package	20	Gramajı Weight	0,116 kg/m
---	----	-------------------	------------

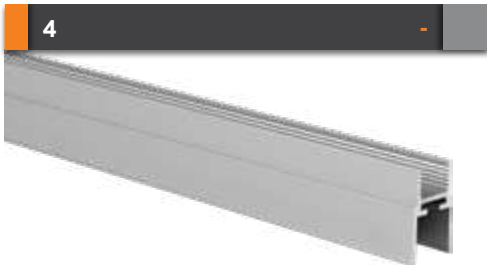

Orta H Fitol
Medium H Wick

Paket İçi Adet Amount within package	20	Gramajı Weight	0,150 kg/m
---	----	-------------------	------------

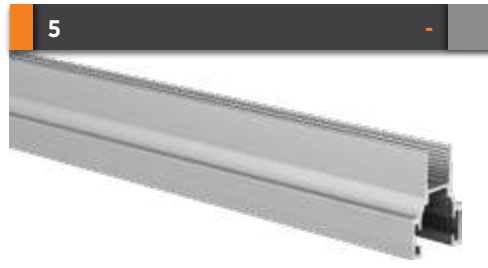

Büyük H Fitol
Big H Wick

Paket İçi Adet Amount within package	20	Gramajı Weight	0,214 kg/m
---	----	-------------------	------------

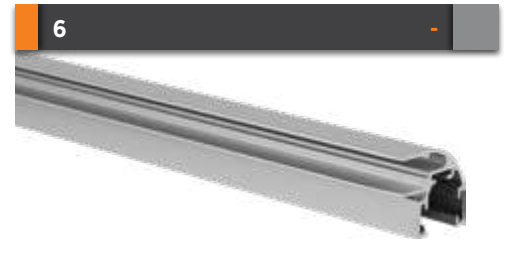

Köşe Dönüş Fitol
Corner Return Wick

Paket İçi Adet Amount within package	10	Gramajı Weight	0,276 kg/m
---	----	-------------------	------------



Alüminyum Renk Seçeneği

Aluminum Color Options

9016

Beyaz
White

E6

Mat Eloksal
Matt Anodized

M0

Mat Bronz
Matt Bronze

P0

Parlak Bronz
Gloss Bronze

8003

Altın Meşe
Golden Oak

8016

Maun
Mahogany

7016

Antrasit Gri
Anthracite Gray

Eloksal Boyalı
Anodized Painted

Bronz Boyalı
Bronze Painted

PRC 01

Gold Dıştan Geçmeli Sistem



Düz Baza Kapak Sağ - Sol
Base Intermediate Cover Flat Right-Left

Paket İçi Adet Amount within package	150	Koli İçi Adet Amount within parcel	1.500
---	-----	---------------------------------------	-------

PRC 02

Gold Dıştan Geçmeli Sistem



Gold Radius Kapak
Gold Radius Cover Flat

Paket İçi Adet Amount within package	100	Koli İçi Adet Amount within parcel	600
---	-----	---------------------------------------	-----

PRC 05

Gold Dıştan Geçmeli Sistem



90° Alt Kapak Sağ - Sol
90° Bottom Cover Right-Left

Paket İçi Adet Amount within package	100	Koli İçi Adet Amount within parcel	400
---	-----	---------------------------------------	-----

PRC 06

Gold Dıştan Geçmeli Sistem



90° Üst Kapak Sağ - Sol
90° Top Cover Right-Left

Paket İçi Adet Amount within package	100	Koli İçi Adet Amount within parcel	400
---	-----	---------------------------------------	-----

PRC 09

Gold Dıştan Geçmeli Sistem



Baza Bitiş Kapak Sağ - Sol
Base Side Column Cover Right-Left

Paket İçi Adet Amount within package	100	Koli İçi Adet Amount within parcel	800
---	-----	---------------------------------------	-----

PRC 11

Gold Dıştan Geçmeli Sistem



22,5° Alt Kapak Sağ - Sol
22,5° Bottom Cover Right-Left

Paket İçi Adet Amount within package	100	Koli İçi Adet Amount within parcel	800
---	-----	---------------------------------------	-----

PRC 12

Gold Dıştan Geçmeli Sistem



22,5° Üst Kapak Sağ - Sol
22,5° Top Cover Right-Left

Paket İçi Adet Amount within package	100	Koli İçi Adet Amount within parcel	800
---	-----	---------------------------------------	-----

PRC 01-PİM

Gold Pimli Sistem



Düz Baza Kapak Pimli Sağ-Sol
Base Intermediate Cover Flat with Pin Right-Left

Paket İçi Adet Amount within package	150	Koli İçi Adet Amount within parcel	1.500
---	-----	---------------------------------------	-------

PRC 05-PİM

Gold Pimli Sistem



90° Alt Kapak Pimli Sağ - Sol
90° Bottom Cover with Pin Right-Left

Paket İçi Adet Amount within package	100	Koli İçi Adet Amount within parcel	400
---	-----	---------------------------------------	-----

PRC 06-PİM

Gold Pimli Sistem



90° Üst Kapak Pimli Sağ - Sol
90° Top Cover with Pin Right-Left

Paket İçi Adet Amount within package	100	Koli İçi Adet Amount within parcel	400
---	-----	---------------------------------------	-----

PRC 09-PİM

Gold Pimli Sistem



Baza Bitiş Kapak Pimli Sağ - Sol
Base Side Column Cover with Pin Right-Left

Paket İçi Adet Amount within package	100	Koli İçi Adet Amount within parcel	800
---	-----	---------------------------------------	-----

PRC 11-PİM

Gold Pimli Sistem



22,5° Alt Kapak Pimli Sağ - Sol
22,5° Bottom Cover with Pin Right-Left

Paket İçi Adet Amount within package	100	Koli İçi Adet Amount within parcel	800
---	-----	---------------------------------------	-----

8mm CAM BALKON AKSESUARLARI

8mm Balcony Glass Accessories

Renk Seçeneği
Color Options

Siyah
Black

process
ALUMINIUM & PVC SYSTEMS

PRC 12-PİM

Gold Pimli Sistem



22,5° Üst Kapak Pimli Sağ - Sol
22,5° Top Cover with Pin Right-Left

Paket İçi Adet Amount within package	100	Koli İçi Adet Amount within parcel	800
---	-----	---------------------------------------	-----

PRC 44

Fırtına Sistem



Fırtına Düz Baza Kapak Sağ - Sol
Fırtına Base Intermediate Cover Flat Right-Left

Paket İçi Adet Amount within package	150	Koli İçi Adet Amount within parcel	1.500
---	-----	---------------------------------------	-------

PRC 46

Fırtına Sistem



Fırtına 90° Alt Kapak Sağ - Sol
Fırtına 90° Bottom Cover Right-Left

Paket İçi Adet Amount within package	100	Koli İçi Adet Amount within parcel	400
---	-----	---------------------------------------	-----

PRC 47

Fırtına Sistem



Fırtına 90° Üst Kapak Sağ - Sol
Fırtına 90° Top Cover Right-Left

Paket İçi Adet Amount within package	100	Koli İçi Adet Amount within parcel	400
---	-----	---------------------------------------	-----

PRC 48

Fırtına Sistem



Fırtına Baza Bitiş Kapak Sağ - Sol
Fırtına Base Side Column Cover Right-Left

Paket İçi Adet Amount within package	100	Koli İçi Adet Amount within parcel	800
---	-----	---------------------------------------	-----

PRC 50

Fırtına Sistem



Fırtına 22,5° Alt Kapak Sağ - Sol
Fırtına 22,5° Bottom Cover Right-Left

Paket İçi Adet Amount within package	100	Koli İçi Adet Amount within parcel	800
---	-----	---------------------------------------	-----

PRC 51

Fırtına Sistem



Fırtına 22,5° Üst Kapak Sağ - Sol
Fırtına 22,5° Top Cover Right-Left

Paket İçi Adet Amount within package	100	Koli İçi Adet Amount within parcel	800
---	-----	---------------------------------------	-----

PRC 14



Kilitli Metal Teker
Locking Wheel with Stainless Pin (Metal)

Paket İçi Adet Amount within package	250	Koli İçi Adet Amount within parcel	250
---	-----	---------------------------------------	-----

PRC 13



Düz Metal Teker
Plain Wheel with Stainless Pin (Metal)

Paket İçi Adet Amount within package	250	Koli İçi Adet Amount within parcel	250
---	-----	---------------------------------------	-----

PRC 82



8 mm İspanyolet Karşılık Aksesuarı
8 mm Espagnolette Return Accessory

Paket İçi Adet Amount within package	250	Koli İçi Adet Amount within parcel	1.000
---	-----	---------------------------------------	-------

PRC 32



Plastik Zincir
Plastic Bead Rope

Paket İçi Adet Amount within package	200 m	Koli İçi Adet Amount within parcel	2.400 m
---	-------	---------------------------------------	---------

PRC 33



Plastik Zincir Tutamağı
Plastic Bead Rope Handle

Paket İçi Adet Amount within package	700	Koli İçi Adet Amount within parcel	700
---	-----	---------------------------------------	-----

PRC 17



Yönlendirici Boynuz
Router

Paket İçi Adet Amount within package	50	Koli İçi Adet Amount within parcel	300
---	----	---------------------------------------	-----

PRC 18



Kilit
Lock

Paket İçi Adet Amount within package	100	Koli İçi Adet Amount within parcel	700
---	-----	---------------------------------------	-----

PRC 26



Borulu Stoplama
Stopper

Paket İçi Adet Amount within package	150	Koli İçi Adet Amount within parcel	150
---	-----	---------------------------------------	-----

PRC 22



Polyemit Lama 4'lü
Guide and Brake for System (4)

Paket İçi Adet Amount within package	200	Koli İçi Adet Amount within parcel	200
---	-----	---------------------------------------	-----

PRC 23



Polyemit Lama 7'li
Guide and Brake for System (7)

Paket İçi Adet Amount within package	200	Koli İçi Adet Amount within parcel	200
---	-----	---------------------------------------	-----

PRC 24



Polyemit Lama 10'lü
Guide and Brake for System (10)

Paket İçi Adet Amount within package	100	Koli İçi Adet Amount within parcel	100
---	-----	---------------------------------------	-----

PRC 20



Teker Çıkış Plastiği U
Outlet Plastics U

Paket İçi Adet Amount within package	100	Koli İçi Adet Amount within parcel	800
---	-----	---------------------------------------	-----

PRC 79



U Çıkış Plastik Kapağı
Outlet Plastic Cover U

Paket İçi Adet Amount within package	500	Koli İçi Adet Amount within parcel	500
---	-----	---------------------------------------	-----

PRC 21



Polyemit Lama Tekli
Guide and Brake for System

Paket İçi Adet Amount within package	300	Koli İçi Adet Amount within parcel	300
---	-----	---------------------------------------	-----

PRC 25



İnce Yan Dikme Aparatı
Thin Side Column Equipment Sys.

Paket İçi Adet Amount within package	150	Koli İçi Adet Amount within parcel	1.500
---	-----	---------------------------------------	-------

PRC 52



Kalın Yan Dikme Aparatı
Thick Side Column Equipment Sys.

Paket İçi Adet Amount within package	100	Koli İçi Adet Amount within parcel	600
---	-----	---------------------------------------	-----

PRC 77



Geniş Yan Dikme Aparatı
Wide Side Column Equipment Sys.

Paket İçi Adet Amount within package	100	Koli İçi Adet Amount within parcel	600
---	-----	---------------------------------------	-----

8mm CAM BALKON AKSESUARLARI

8mm Balcony Glass Accessories

PRC 27



Alüminyum Köşe Dönüş Takımı
Hinged T-square

Paket İçi Adet Amount within package	200	Koli İçi Adet Amount within parcel	200
---	-----	---------------------------------------	-----

PRC 28



Menteşe Takımı Pim Ayarlı Üst
Hinge Up - Adjustable

Paket İçi Adet Amount within package	200	Koli İçi Adet Amount within parcel	200
---	-----	---------------------------------------	-----

PRC 29



Menteşe Takımı Pim Ayarlı Alt
Hinge Bottom - Adjustable

Paket İçi Adet Amount within package	200	Koli İçi Adet Amount within parcel	200
---	-----	---------------------------------------	-----

PRC 30



Menteşe Takımı Üst
Hinge Up

Paket İçi Adet Amount within package	200	Koli İçi Adet Amount within parcel	400
---	-----	---------------------------------------	-----

PRC 31



Menteşe Takımı Alt
Hinge Bottom

Paket İçi Adet Amount within package	200	Koli İçi Adet Amount within parcel	400
---	-----	---------------------------------------	-----

ZZ 126



İspanyolet Kol
Espagnolette Handle

Paket İçi Adet Amount within package	1	Koli İçi Adet Amount within parcel	40
---	---	---------------------------------------	----

ZZ 068

Antrasit Gri
Anthracite Gray



Akustik Kol
Acoustic Handle

Paket İçi Adet Amount within package	1	Koli İçi Adet Amount within parcel	50
---	---	---------------------------------------	----

PRC 68

Antrasit Gri
Anthracite Gray



Eksenel Kol
Double Glass Axial Handle

Paket İçi Adet Amount within package	1	Koli İçi Adet Amount within parcel	10
---	---	---------------------------------------	----



Baza Profil
Double Glass Base

Paket İçi Adet Amount within package	6	Gramajı Weight	0,618 kg/m
---	---	-------------------	------------



Düz Kapak Profil
Double Glass Flat Cover Profile

Paket İçi Adet Amount within package	6	Gramajı Weight	0,321 kg/m
---	---	-------------------	------------



Düz Kapak Mentеше Profil
Double Glass Flat Cover with Hinge Profile

Paket İçi Adet Amount within package	6	Gramajı Weight	0,327 kg/m
---	---	-------------------	------------



45° Dönüş Profil
45° Return Profile

Paket İçi Adet Amount within package	6	Gramajı Weight	0,445 kg/m
---	---	-------------------	------------



22,5° Dönüş Profil
22,5° Return Profile

Paket İçi Adet Amount within package	6	Gramajı Weight	0,378 kg/m
---	---	-------------------	------------



11° Dönüş Profil
11° Return Profile

Paket İçi Adet Amount within package	6	Gramajı Weight	0,366 kg/m
---	---	-------------------	------------

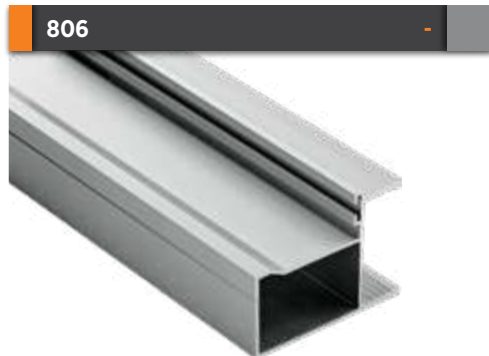

90° Dönüş Profil
90° Return Profile

Paket İçi Adet Amount within package	6	Gramajı Weight	0,475 kg/m
---	---	-------------------	------------



Açılı Dönüş Mentеше Profil
PopUp Return Hinge Profile

Paket İçi Adet Amount within package	6	Gramajı Weight	0,346 kg/m
---	---	-------------------	------------



Isıcam Yan Dikme Profil
Double Glass Side Column Profile

Paket İçi Adet Amount within package	6	Gramajı Weight	0,369 kg/m
---	---	-------------------	------------



Sabit Cam Mentеше Profil
Stable Glass Hinge Profile

Paket İçi Adet Amount within package	6	Gramajı Weight	0,328 kg/m
---	---	-------------------	------------



Sabit Cam (Tijli) Kilit Profil
Stable Glass Lock Profile

Paket İçi Adet Amount within package	6	Gramajı Weight	0,355 kg/m
---	---	-------------------	------------



Sabit Cam (Tijli) Kilit Karşılık Profil
Stable Glass Lock Combination Profile

Paket İçi Adet Amount within package	6	Gramajı Weight	0,342 kg/m
---	---	-------------------	------------

ISICAMLI CAM BALKON PROFİLLERİ

Glazed with Thermopane Glass Balcony Profiles

819



Düz Kasa Üstten Fitilli Profil
Flat Case Top Wicked Profile

Paket İçi Adet Amount within package	3	Gramajı Weight	1,344 kg/m
---	---	-------------------	------------

820



Oluklu Kasa Üstten Fitilli Profil
Corrugated Case Top Wicked Profile

Paket İçi Adet Amount within package	3	Gramajı Weight	1,389 kg/m
---	---	-------------------	------------

822



Açılır Dikme Profil
PopUp Column Profile

Paket İçi Adet Amount within package	6	Gramajı Weight	0,378 kg/m
---	---	-------------------	------------

816



Üstten Fitilli Büyük Oluklu Kasa
Large Corrugated Case with Top Wick

Paket İçi Adet Amount within package	3	Gramajı Weight	1,577 kg/m
---	---	-------------------	------------

817



Üstten Fitilli Büyük Düz Kasa
Large Flat Case with Wed from Top

Paket İçi Adet Amount within package	3	Gramajı Weight	1,532 kg/m
---	---	-------------------	------------

815



Tij Profil
Espagnolette Profile

Paket İçi Adet Amount within package	10	Gramajı Weight	0,100 kg/m
---	----	-------------------	------------

823



Isıcam Geniş Yan Dikme
Double Glass Wide Side Column

Paket İçi Adet Amount within package	6	Gramajı Weight	0,459 kg/m
---	---	-------------------	------------

824



Sabit Cam İspanyolet Profil
Fixed Glass Espagnolette Profile

Paket İçi Adet Amount within package	6	Gramajı Weight	0,583 kg/m
---	---	-------------------	------------

825



Sabit Cam İspanyolet Karşılık Profil
Fixed Glass Espagnolette Handle Provision Profile

Paket İçi Adet Amount within package	6	Gramajı Weight	0,356 kg/m
---	---	-------------------	------------

Alüminyum Renk Seçeneği

Aluminum Color Options

9016

Beyaz
White

E6

Mat Eloksal
Matt Anodized

M0

Mat Bronz
Matt Bronze

PO

Parlak Bronz
Gloss Bronze

8003

Altın Meşe
Golden Oak

8016

Maun
Mahogany

7016

Antrasit Gri
Anthracite Gray

Eloksal Boyalı

Anodized Painted

Bronz Boyalı

Bronze Painted

ZZ 126



İspanyolet Kol
Espagnolette Handle

Paket İçi Adet Amount within package	1	Koli İçi Adet Amount within parcel	40
---	---	---------------------------------------	----

ZZ 068

Antrasit Gri
Anthracite Gray



Akustik Kol
Acoustic Handle

Paket İçi Adet Amount within package	1	Koli İçi Adet Amount within parcel	50
---	---	---------------------------------------	----

PRC 68

Antrasit Gri
Anthracite Gray



Eksenel Kol
Double Glass Axial Handle

Paket İçi Adet Amount within package	1	Koli İçi Adet Amount within parcel	10
---	---	---------------------------------------	----

PRC 76



Kilit Karşılık (Metal)
Double Glass Lock Provision (Metal)

Paket İçi Adet Amount within package	100	Koli İçi Adet Amount within parcel	400
---	-----	---------------------------------------	-----

PRC 63



Bağlantı Adaptörü
Double Glass Connection Adapter

Paket İçi Adet Amount within package	100	Koli İçi Adet Amount within parcel	400
---	-----	---------------------------------------	-----

PRC 65



Destek Takozu
Double Glass Bracket Wedge

Paket İçi Adet Amount within package	100	Koli İçi Adet Amount within parcel	400
---	-----	---------------------------------------	-----

PRC 75



Sistem Tij Pimi
System Rod Pin

Paket İçi Adet Amount within package	100	Koli İçi Adet Amount within parcel	200
---	-----	---------------------------------------	-----

PRC 73



Isı Cam EPDM Kauçuk Fitol Çift Conta
Double Glass EPDM Rubber Wick Double Gasket

Paket İçi Adet Amount within package	1 Top (10 kg)	Koli İçi Adet Amount within parcel	125 m
---	---------------	---------------------------------------	-------

PRC 74



Isı Cam EPDM Kauçuk Fitol Tek Conta
Double Glass EPDM Rubber Wick Single Gasket

Paket İçi Adet Amount within package	1 Top (10 kg)	Koli İçi Adet Amount within parcel	290 m
---	---------------	---------------------------------------	-------

Alüminyum Renk Seçeneği

Aluminum Color Options

9016 Beyaz White	E6 Mat Eloksal Matt Anodized	M0 Mat Bronz Matt Bronze	P0 Parlak Bronz Gloss Bronze
8003 Altın Meşe Golden Oak	8016 Maun Mahogany	7016 Antrasit Gri Anthracite Gray	Eloksal Boyalı Anodized Painted
			Bronz Boyalı Bronze Painted

210



Sürme Baza Profil
Sliding Base Profile

Paket İçi Adet Amount within package	4	Gramajı Weight	0,643 kg/m
---	---	-------------------	------------

215



Çekme Kol Profil
Pull Handle Profile

Paket İçi Adet Amount within package	3	Gramajı Weight	0,908 kg/m
---	---	-------------------	------------

212



Kenet Profil
Clamp Profile

Paket İçi Adet Amount within package	6	Gramajı Weight	0,423 kg/m
---	---	-------------------	------------

211



Birleştirme Karşılık Profil
Combination Provisions Profile

Paket İçi Adet Amount within package	6	Gramajı Weight	0,301 kg/m
---	---	-------------------	------------

213



İkili Eşikli Alt Kasa Profil
Double Threshold Lower Case Profile

Paket İçi Adet Amount within package	4	Gramajı Weight	0,974 kg/m
---	---	-------------------	------------

222



Üçlü Eşikli Alt Kasa Profil
Triple Threshold Lower Case Profile

Paket İçi Adet Amount within package	2	Gramajı Weight	1,333 kg/m
---	---	-------------------	------------

220



Üçlü Eşiksiz Alt Kasa Profil
Triple Bottom Case Profile without Threshold

Paket İçi Adet Amount within package	4	Gramajı Weight	0,867 kg/m
---	---	-------------------	------------

229



İkili Üst Kasa Profil
Double Upper Case Profile

Paket İçi Adet Amount within package	3	Gramajı Weight	1,120 kg/m
---	---	-------------------	------------

230



Üçlü Üst Kasa Profil
Triple Upper Case Profile

Paket İçi Adet Amount within package	2	Gramajı Weight	1,552 kg/m
---	---	-------------------	------------

221



Dörtlü Eşiksiz Alt Kasa Profil
Quadruple Bottom Case Profile without Threshold

Paket İçi Adet Amount within package	2	Gramajı Weight	1,156 kg/m
---	---	-------------------	------------

214



İkili Yan Kasa Profil
Double Side Case Profile

Paket İçi Adet Amount within package	4	Gramajı Weight	0,587 kg/m
---	---	-------------------	------------

223



Üçlü Yan Kasa Profil
Triple Side Case Profile

Paket İçi Adet Amount within package	2	Gramajı Weight	0,792 kg/m
---	---	-------------------	------------

219 Tek cam adaptörü/ Single glass adapter



8 mm Cam Adaptörü
8 mm Glass Adapter

Paket İçi Adet Amount within package	10	Gramajı Weight	0,219 kg/m
---	----	-------------------	------------

226



Kapatma Profili
Closing Profile

Paket İçi Adet Amount within package	10	Gramajı Weight	0,071 kg/m
---	----	-------------------	------------

227



İspanyolet Çekme Kol Profili
Espagnolette Pull Handle Profile

Paket İçi Adet Amount within package	4	Gramajı Weight	0,957 kg/m
---	---	-------------------	------------

228



İspanyolet Karşılık Profili
Espagnolette Provision Profile

Paket İçi Adet Amount within package	10	Gramajı Weight	0,156 kg/m
---	----	-------------------	------------



PSS 1

Siyah
Black



Çekme Kol Profil Aksesuarı
Sliding Profile Plastic

Paket İçi Adet Amount within package	50	Koli İçi Adet Amount within parcel	200
---	----	---------------------------------------	-----

PSS 2

Siyah
Black



Kenet Profil Aksesuarı - Üst
Tensile Profile Plastic Top

Paket İçi Adet Amount within package	50	Koli İçi Adet Amount within parcel	200
---	----	---------------------------------------	-----

PSS 3

Siyah
Black



Kenet Profil Aksesuarı - Alt
Tensile Profile Plastic Bottom

Paket İçi Adet Amount within package	50	Koli İçi Adet Amount within parcel	200
---	----	---------------------------------------	-----

PSS 4

Siyah
Black



İspanyollet Çekme Kol Aksesuarı
Espagnolette Pull Handle Accessory

Paket İçi Adet Amount within package	50	Koli İçi Adet Amount within parcel	200
---	----	---------------------------------------	-----

PSS 5

Siyah
Black



İkili Köşe Takoğu
Double Corner Wedge

Paket İçi Adet Amount within package	50	Koli İçi Adet Amount within parcel	200
---	----	---------------------------------------	-----

PSS 6

Siyah
Black



Üçlü Köşe Takoğu
Triple Corner Wedge

Paket İçi Adet Amount within package	50	Koli İçi Adet Amount within parcel	200
---	----	---------------------------------------	-----

PSS 7

Siyah
Black



Vida Tapası
Screw Plug

Koli İçi Adet Amount within parcel	2.000
---------------------------------------	-------

PSS 12

Siyah
Black



Sürme Yalıtım Aksesuarı
Sliding Insulation Accessory

Koli İçi Adet Amount within parcel	200
---------------------------------------	-----

PSS 8



Paslanmaz Lüks Teker
Stainless Luxury Wheel

Koli İçi Adet Amount within parcel	200
---------------------------------------	-----

PSS 9



Havuz Kol (Kilitsiz)
Hole Handle (Unlocked)

Paket İçi Adet Amount within package	1	Koli İçi Adet Amount within parcel	1
---	---	---------------------------------------	---

PSS 10



Klips Kol
Clasp Handle

Paket İçi Adet Amount within package	1	Koli İçi Adet Amount within parcel	1
---	---	---------------------------------------	---

PSS 11



Kale 201 F (Horoz) Kilit
Kale 201 F (Pin) Lock

Paket İçi Adet Amount within package	1	Koli İçi Adet Amount within parcel	1
---	---	---------------------------------------	---



140

Sabit Panel Açılır Alt Baza Profil
Fixed Panel Pop-up Base Profile

Paket İçi Adet Amount within package	6	Gramajı Weight	0,563 kg/m
---	---	-------------------	------------



164

Sabit Panel Yan Dikme Profil
Fixed Panel Side Column Profile

Paket İçi Adet Amount within package	4	Gramajı Weight	0,842 kg/m
---	---	-------------------	------------



142

Sabit Panel Üst Baza Profil
Fixed Panel Top Base Profile

Paket İçi Adet Amount within package	4	Gramajı Weight	0,750 kg/m
---	---	-------------------	------------



167

Kenet Baza Profil
Clamp Base Profile

Paket İçi Adet Amount within package	4	Gramajı Weight	1,144 kg/m
---	---	-------------------	------------



144

Hareketli Panel Yan Dikme Profil
Movable Panel Side Column Profile

Paket İçi Adet Amount within package	6	Gramajı Weight	0,434 kg/m
---	---	-------------------	------------



145

Küpeşte Baza Profil
Handrail Base Profile

Paket İçi Adet Amount within package	6	Gramajı Weight	0,579 kg/m
---	---	-------------------	------------



146

Hareketli Panel Açılır Alt Baza Profil
Movable Panel Pop-up Lower Base Profile

Paket İçi Adet Amount within package	4	Gramajı Weight	0,741 kg/m
---	---	-------------------	------------



161

Ray Kapatma "T" Profil
Rail Closure "T" Profile

Paket İçi Adet Amount within package	4	Gramajı Weight	0,482 kg/m
---	---	-------------------	------------



160

Yan Ray "T" Profil
Side Rail "T" Profile

Paket İçi Adet Amount within package	2	Gramajı Weight	1,057 kg/m
---	---	-------------------	------------



166

Açılımlı için Ray Kapatma 'L' Profil
Rail Closure 'L' Profile for Opening

Paket İçi Adet Amount within package	10	Gramajı Weight	0,144 kg/m
---	----	-------------------	------------



162

Yan Ray "L" Profil
Side Rail "L" Profile

Paket İçi Adet Amount within package	4	Gramajı Weight	0,703 kg/m
---	---	-------------------	------------



GYT 28

Et Kalınlığı 1,2 mm
wall thickness 1,2 mm

Sac Tambur Borusu
Sheet Drum Pipe

Paket İçi Adet Amount within package	1	Boy Length	7 m
---	---	---------------	-----



152

Alt Kasa Profil
Lower Case Profile

Paket İçi Adet Amount within package	2	Gramajı Weight	1,563 kg/m
---	---	-------------------	------------



156

Üst Kasa Profil
Top Case Profile

Paket İçi Adet Amount within package	1	Gramajı Weight	3,449 kg/m
---	---	-------------------	------------



153

Üst Kasa Kapak Profil
Top Case Cover Profile

Paket İçi Adet Amount within package	2	Gramajı Weight	0,864 kg/m
---	---	-------------------	------------



155

Yan Kasa Profil
Side Case Profile

Paket İçi Adet Amount within package	2	Gramajı Weight	1,669 kg/m
---	---	-------------------	------------



154

Küpeşte Profil
Handrail Profile

Paket İçi Adet Amount within package	2	Gramajı Weight	0,759 kg/m
---	---	-------------------	------------



165

Yan Kasa Kertme Profil
Side Case Notched Profile

Paket İçi Adet Amount within package	4	Gramajı Weight	0,644 kg/m
---	---	-------------------	------------



158

Açılımsız Tek Fıtil Yan Ray L Kasa Profil
Single Weatherstrips Without Opening Side L Case Profile

Paket İçi Adet Amount within package	4	Gramajı Weight	0,510 kg/m
---	---	-------------------	------------



159

Açılımsız Çift Fıtil Yan Ray L Kasa Profil
Double Weatherstrips Without Opening Side L Case Profile

Paket İçi Adet Amount within package	4	Gramajı Weight	0,660 kg/m
---	---	-------------------	------------



219

Tek Cam Adaptörü / Single Glass Adapter

8 mm Cam Adaptörü
8mm Glass Adapter

Paket İçi Adet Amount within package	10	Gramajı Weight	0,219 kg/m
---	----	-------------------	------------



149

Açılımsız İçin Ray Kapatma 'L' Profil
Rail Closure 'L' Profile for Non-Opening

Paket İçi Adet Amount within package	10	Gramajı Weight	0,162 kg/m
---	----	-------------------	------------

Alüminyum Renk Seçeneği

Aluminum Color Options



9016
Beyaz
White



E6
Mat Eloksal
Matt Anodized



MO
Mat Bronz
Matt Bronze



8003
Altın Meşe
Golden Oak



8016
Maun
Mahogany



7016
Antrasit Gri
Anthracite Gray



9005
Siyah
Black

GYT 1

Siyah
Black



Küpeste Baza Profil Aksesuarı
Handrail Base Profile Accessories

Koli İçi Adet
Amount within parcel 100

GYT 2

Siyah
Black



Sabit Panel Aksesuar - Alt
Fixed Panel Accessory - Bottom

Koli İçi Adet
Amount within parcel 100

GYT 3 A

Siyah
Black



Kenet Kapak Profil - Sağ / Sol - 146
Clamp Profile Plastics - Right / Left - 146

Koli İçi Adet
Amount within parcel 200

GYT 3 B

Siyah
Black



Kenet Kapak Profil - Sağ / Sol - 167
Clamp Profile Plastics - Right / Left - 167

Koli İçi Adet
Amount within parcel 400

GYT 4



Oluklu Köşe Takozu
Corrugated Corner Wedge

Koli İçi Adet
Amount within parcel 50

GYT 5



Köşe Takozu
Corner Wedge

Koli İçi Adet
Amount within parcel 100

GYT 6

Siyah
Black



Üst Kasa Rulmanlı Kapak
Top Case Bearing Cover

Koli İçi Adet
Amount within parcel 20

GYT 7

Siyah
Black



Üst Kasa Motor Bağlantı Kapak
Top Case Engine Connection Cover

Koli İçi Adet
Amount within parcel 20

GYT 8

Siyah
Black



Yan Kasa Köşe Birleştirme Takozu
Side Case Corner Joint Plastic

Koli İçi Adet
Amount within parcel 100

GYT 9

Siyah
Black



Küpeste Kapağı - Sağ / Sol
Handrail Cover - Right / Left

Koli İçi Adet
Amount within parcel 200

GYT 10

Siyah
Black



Zincir Kapama Aksesuar Sağ/Sol
Chain Cover Accessory - Right / Left

Koli İçi Adet
Amount within parcel 200

GYT 11

Siyah
Black



Çift Açılır Sabit Panel Aksesuar Üst - Sağ/Sol
Double Open Fixed Panel Accessory Top - Right/Left

Koli İçi Adet
Amount within parcel 200

GYT 27

Siyah
Black



Açılımsız Sabit Panel Aksesuar - Alt
Fixed Panel Accessory without Opening - Bottom

Koli İçi Adet
Amount within parcel 100

GYT 12



Giyyotin Makası
Guillotine Junction

Koli İçi Adet
Amount within parcel 6 Set/Sets

GYT 13

Siyah
Black



Orta Panel Çeliđi
Center Panel Steel

Koli İçi Adet
Amount within parcel 40

GYT 14

Siyah
Black



Kilit Takımı
Lock Set

Koli İçi Adet
Amount within parcel 100

GYT 15

Siyah
Black



Zincir Bađlantı Elemanı
Chain Connector

Koli İçi Adet
Amount within parcel 40

GYT 16



Tekerli Bađlantı Elemanı
Wheel Connector

Koli İçi Adet
Amount within parcel 80

GYT 17

Siyah
Black



Panel Hizalama - Sađ/Sol
Panel Aligning - Right/Left

Koli İçi Adet
Amount within parcel 100

GYT 19



Tambur Bađlantı Elemanı
Drum Connector

Koli İçi Adet
Amount within parcel 20

GYT 20



Zincir Diđli
Sprocket

Koli İçi Adet
Amount within parcel 20

GYT 18

Siyah
Black



Zincir Yönlendirici
Chain Router

Koli İçi Adet
Amount within parcel 100

GYT 21



Zincir
Chain

Koli İçi Adet
Amount within parcel 1 (5 m)

GYT 25



Zincir Ađırlık
Chain Weight

Koli İçi Adet
Amount within parcel 16

GYT 26

Siyah
Black



Sabit Panel Sızdırmazlık Contası
Fixed Panel Sealing Gasket

Koli İçi Adet
Amount within parcel

200 m

GYT 30

Siyah
Black



Üst Kasa Balon Conta
Top Case Balloon Gasket

Koli İçi Adet
Amount within parcel

100 m

GYT 31

Somfy

somfy.



Giyotin Motor (120Nm)
Guillotine Engine (120Nm)

Koli İçi Adet
Amount within parcel

1

KMD 1

Somfy

somfy.



Motor Kumandası (tekli)
Engine Remote Control (mono)

Koli İçi Adet
Amount within parcel

1

KMD 2

Somfy

somfy.



Motor Kumandası (çoklu)
Engine Remote Control (multi)

Koli İçi Adet
Amount within parcel

1

GYT 32

A-OK

A-OK

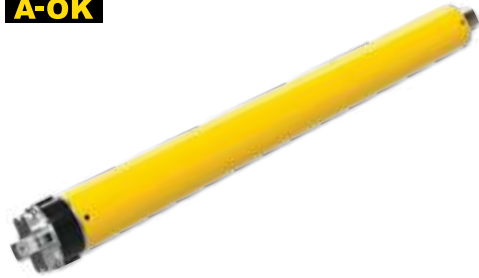

Giyotin Motor (120Nm)
Guillotine Engine (120Nm)

Koli İçi Adet
Amount within parcel

1

KMD 3

A-OK

A-OK



Motor Kumandası (tekli)
Engine Remote Control (mono)

Koli İçi Adet
Amount within parcel

1

KMD 4

A-OK

A-OK



Motor Kumandası (çoklu)
Engine Remote Control (multi)

Koli İçi Adet
Amount within parcel

1



417

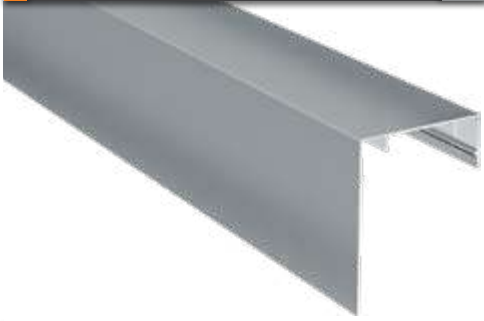

Sonlandırıcı Cam Çıta Kapak Profili
End Cap Glass Strip Cover Profile

Paket İçi Adet Amount within package	6	Gramajı Weight	0,467 kg/m
---	---	-------------------	------------

418



Cam Çıta Kapak Profili
Glass Strip Cover Profile

Paket İçi Adet Amount within package	10	Gramajı Weight	0,329 kg/m
---	----	-------------------	------------

419



Orta Kayıt Profili
Center Mullion Profile

Paket İçi Adet Amount within package	2	Gramajı Weight	2,100 kg/m
---	---	-------------------	------------

420

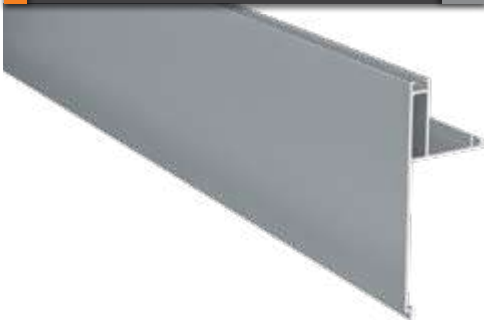

Kasa Kapatma Profili
Frame Closure Profile

Paket İçi Adet Amount within package	4	Gramajı Weight	0,682 kg/m
---	---	-------------------	------------

421



Ayak Profili
Leg Profile

Paket İçi Adet Amount within package	1	Gramajı Weight	3,184 kg/m
---	---	-------------------	------------

422



Oluk Profili
Groove Profile

Paket İçi Adet Amount within package	1	Gramajı Weight	4,318 kg/m
---	---	-------------------	------------

423



Destekli Orta Kayıt Profili
Reinforced Center Mullion Profile

Paket İçi Adet Amount within package	2	Gramajı Weight	3,142 kg/m
---	---	-------------------	------------

424



Duvar Kasa Profili
Wall Frame Profile

Paket İçi Adet Amount within package	1	Gramajı Weight	2,835 kg/m
---	---	-------------------	------------

425



Cam Çıtası Profili
Glass Strip Profile

Paket İçi Adet Amount within package	4	Gramajı Weight	0,847 kg/m
---	---	-------------------	------------

426



Gizli Ayak Profili
Hidden Leg Profile

Paket İçi Adet Amount within package	1	Gramajı Weight	3,434 kg/m
---	---	-------------------	------------

427



Destek Kutu Profili
Reinforcing Box Profile

Paket İçi Adet Amount within package	2	Gramajı Weight	2,271 kg/m
---	---	-------------------	------------

428



Gizli Ayak ve Destek Kutu Kapatma Profili
Hidden Leg Case Cover Support Profile

Paket İçi Adet Amount within package	8	Gramajı Weight	0,501 kg/m
---	---	-------------------	------------

CT 01

Siyah
Black



Orta Kayıt Plastik Kapak
Middle Mullion Plastic Cover

Koli İçi Adet
Amount within parcel 60

CT 02

⊕ Renk seçenekleri mevcuttur
⊕ Color options are available



Ayak Profili Sabitleme Aksesuarı
Leg Profile Fixing Accessory

Koli İçi Adet
Amount within parcel 20

CT 03

⊕ Renk seçenekleri mevcuttur
⊕ Color options are available



Metal Oluk Kasa Kapak
Metal Gutter Box Cover

Koli İçi Adet
Amount within parcel 20

CT 04

⊕ Renk seçenekleri mevcuttur
⊕ Color options are available



Metal Duvar Kasa Kapak
Metal Wall Casing Cover

Koli İçi Adet
Amount within parcel 20

CT 05



Oluklu Kasa Bağlantı Aksesuarı
Corrugated Box Connection Accessory

Koli İçi Adet
Amount within parcel 100

CT 06



Duvar Kasa Bağlantı Aksesuarı
Wall Casing Connection Accessory

Koli İçi Adet
Amount within parcel 100

CT 07

Siyah
Black

CT 08



Orta Kayıt Contası
Middle Mullion Gasket

Koli İçi Adet
Amount within parcel 200 mt

Cam Çıta Contası
Glass Strip Gasket

Koli İçi Adet
Amount within parcel 140 mt

CT 09

Siyah
Black



Oluk Kasa Yalıtım Yaprak Contası
Gutter Box Insulation Leaf Gasket

Koli İçi Adet
Amount within parcel 85 mt

CT 10

Siyah
Black



Duvar Kasa Yalıtım Yaprak Contası
Wall Casing Insulation Leaf Gasket

Koli İçi Adet
Amount within parcel 55 mt

CT 11

⊕ Renk seçenekleri mevcuttur
⊕ Color options are available



Gizli Ayak Profili Sabitleme Aksesuarı
Hidden Leg Profile Fixing Accessory

Koli İçi Adet
Amount within parcel 20

CT 12

⊕ Renk seçenekleri mevcuttur
⊕ Color options are available



Destek Kutu Sabitleme Aksesuarı
Reinforcing Box Fixing Accessory

Koli İçi Adet
Amount within parcel 40

CT 13

Siyah
Black



Filtre Kapağı
Filter Cover

Koli İçi Adet
Amount within parcel 20

Plise Perde

Perdecilik sektörünün teknolojik gelişmelere paralel olarak sürekli bir ilerleme göstermesinin sonucunda tüm mekanlarda kullanılabilecek yeni nesil perde sistemleri geliştirerek müşterilerimizin konforunu sağlamayı hedefliyoruz. Klasik perde kumaşlarından farklı olarak güneş ışınlarını filtrelemek, mekanlarda ısı dengesini sağlamak gibi işlevleri olan teknik kumaşlardan yapılan modern perde modellerinin kullanımı giderek daha yaygın hale geliyor. İple kontrol edilenlerinin yanında motorlu alternatifleri de olan plise perde modelleri özellikle modern tarzda dekore edilmiş mekanlara çok iyi uyum sağlıyor.

Özellikleri

Plise perde sistemlerinin katlanır cam balkonlar, geometrik pencereler PVC pencere ve kapılar için çözüm odaklı olduğunu söylesek yanılmış olmayız. Aynı zaman da sürekli olarak ulaşılması zor noktalar için de başarılı çözümler geliştirmiştir. Yarı geçirgen yapısı sayesinde aydınlık ortamlar yaratır.

Katlanır cam balkon sistemlerinde, PVC pencere ve kapılarda, Winter Garden(Kış Bahçesi) Sistemlerde, yat, tekne, tavan perdeleri, çatı perdesi, eğimli ve geometrik pencereler vs. uygulamalarda kullanılmaktadır. Motorlu ve kumandalı sistemlerinde çok rahatlıkla uygulandığı modeller arasındadır.

Yıkabilen, silinebilen özelliği ile plise perde sistemleri kolay kullanım sağlar. Aynı zaman da alev almama özelliği ile de sağlıklı ortamlar yaratır.



Mekanlarda Sade ve Modern Bir Görünüm

Plise perdelerin görünümü sade ve detaysızdır, bu yüzden hemen her ortama uyum sağlarlar. Biraz modern – biraz klasik veya daha gösterişli bir görünüm istediğiniz mekanlar için plise perdeyi kumaş perdelerle kombinleyerek de kullanabilirsiniz.



Plise Perde Nedir?

Katlanır cam balkon sistemleri ve PVC Kapı, pencereler için sıklıkla tercih edilen, ipli mekanizmasıyla aşağı-yukarı yönlü hareket imkanı sağlayan, mekanda gün ışığının yumuşak bir şekilde dağılımını sağlayan bir perde türüdür. Özellikle çatı katları, gemiler, kış bahçeleri, katlanır cam balkon sistemleri gibi mekanların çok köşeli, eğimli, bazen ulaşılması zor olan pencereleri için kullanılmaya uygundur. Görünümü dekoratif, kullanımı pratiktir. Belli bir boyuta kadar tek parça olarak uygulanabildiği gibi ayrı cam kanatlara uygun ebattaki parçalar halinde monte edilerek uygulanabilmektedir.

Modern bir dizaynı olan bu fonksiyonel perde türü tasarım ilkelerinin bir avantajı olarak mekanlarda enerji sarfiyatının azaltılmasına yardımcı olur. Güçlü ve kullanışlı bir perde türüdür. Katlanmış hali çok az yer kapladığı için görüntü kirliliğine yol açmaz. 3 metre uzunluğundaki bir tepe penceresine uygulanması durumunda, toplandığında kapladığı yer 10 cm civarındadır. Farklı renk seçenekleri mevcuttur. Esnek yapısı sayesinde dar bölgelerde, asimetrik formlu, üçgen veya dairesel pencerelerde, tavanlarda kullanılabilir. Pencere kanatlarıyla tavan arasındaki mesafenin az olması durumunda da uygulanabilir. Mekanları sıcak günlerde fazla ısınmaktan korur, istenilen ölçüde mahremiyet sağlar.

Tavan camları veya cam balkon için perdeye ihtiyacınız varsa plise perde sizin için en iyi seçim olacaktır.

İple Kontrol Etmek Tek Seçenek Değil

Plise perdenizi mekanizmasındaki ip sistemi yardımıyla kontrol edebilir veya motorlu olarak üretilmesini tercih edebilirsiniz.



T Profil Kapak
T Profile Cover

Paket İçi Adet Amount within package	1.000	Koli İçi Adet Amount within parcel	2.000
---	-------	---------------------------------------	-------



Small T Profil Kapak
Small T Profile Cover

Paket İçi Adet Amount within package	1.000	Koli İçi Adet Amount within parcel	2.000
---	-------	---------------------------------------	-------



Çiftli Orta Profil Kapak
Double Middle Profile Cover

Paket İçi Adet Amount within package	500	Koli İçi Adet Amount within parcel	500
---	-----	---------------------------------------	-----



20'lik T Profil Kapak
20 T Profile Cover

Paket İçi Adet Amount within package	1.000	Koli İçi Adet Amount within parcel	2.000
---	-------	---------------------------------------	-------



Yaylı Yapışkan Profil Kapak
Spring Adhesive Profile Cover

Paket İçi Adet Amount within package	1.000	Koli İçi Adet Amount within parcel	2.000
---	-------	---------------------------------------	-------



Yaylı Portray Profil Kapak
Spring Portray Profile Cover

Paket İçi Adet Amount within package	1.000	Koli İçi Adet Amount within parcel	2.000
---	-------	---------------------------------------	-------



Kilit Takımı (Çıtırıtılı)
Lock Set (with snap fastener)

Paket İçi Adet Amount within package	2.000	Koli İçi Adet Amount within parcel	2.000
---	-------	---------------------------------------	-------

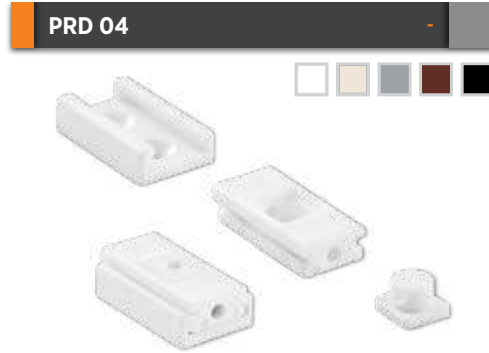

Kilit Takımı (Alyanlı)
Lock Set (with hex key)

Paket İçi Adet Amount within package	2.000	Koli İçi Adet Amount within parcel	2.000
---	-------	---------------------------------------	-------

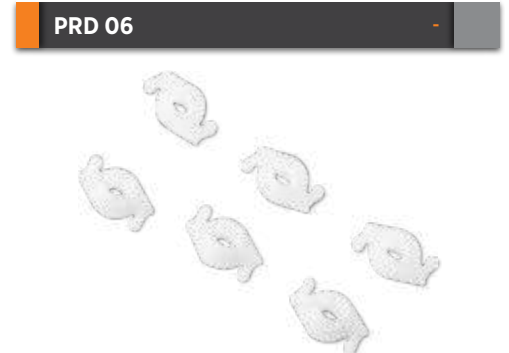

Çiftli Orta Profil Klips
Double Middle Profile Clip

Paket İçi Adet Amount within package	500	Koli İçi Adet Amount within parcel	500
---	-----	---------------------------------------	-----



Yaylı Portray Klips
Spring Portray Cleps

Koli İçi Adet Amount within parcel	500
---------------------------------------	-----



Kuş Gözü (Metal) 4 mm **Kuş Gözü (Metal) 3 mm**
Rivet (Metal) 4 mm Rivet (Metal) 3 mm

Koli İçi Adet Amount within parcel	5.000	Koli İçi Adet Amount within parcel	5.000
---------------------------------------	-------	---------------------------------------	-------



Kuş Gözü (Plastik)
Rivet (Plastic)

Paket İçi Adet Amount within package	10.000
---	--------

PRD 47



Çiftli Orta Profil Klips Anahtarı (Metal)
Double Middle Profile Clip Key (Metal)

Paket İçi Adet Amount within package	1	Koli İçi Adet Amount within parcel	1
---	---	---------------------------------------	---

PRD 35



Perde Çekme Aparatı
Curtain Pulling Apparatus

Paket İçi Adet Amount within package	1	Koli İçi Adet Amount within parcel	1
---	---	---------------------------------------	---

PRD 34



Montaj Vidası (2,9x6,5 YHB)
Mounting Screw (2.9x6.5 YHB)

Koli İçi Adet Amount within parcel	10.000
---------------------------------------	--------

PRD 07



12 mm Bantlı Şerit
12 mm Taped Strip

Paket İçi Adet Amount within package	50	Koli İçi Adet Amount within parcel	500
---	----	---------------------------------------	-----

PRD 39



Çift Taraflı Silikonlu Bant
Double Sided Silicone Tape

Paket İçi Adet Amount within package	1	Koli İçi Adet Amount within parcel	35 m
---	---	---------------------------------------	------

PRD 05



Plise Perde İp
Pleat Curtain Rope

Paket İçi Adet Amount within package	1 rulo/ roll	Koli İçi Adet Amount within parcel	12
---	--------------	---------------------------------------	----

PRD 30

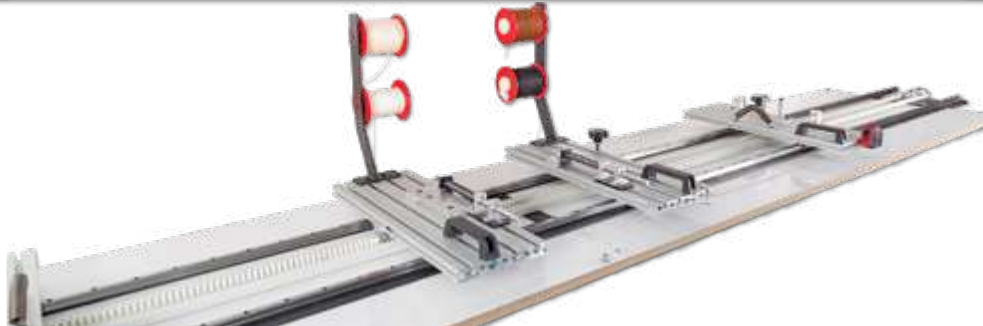

İp Ayar Boylama Tezgahı
Rope Adjustment Lengthening Machine

PRD 31



Kumaş Delme Makinesi
Fabric Punching Machine

PRD 32



Kumaş Kesim Makinesi
Fabric Cutting Machine

PRD 33



Perçin Makinesi
Rivet Machine

PLİSE PERDE PROFİLLERİ

Pleated Blinds Profiles



312

T Profil
T Profile

Paket İçi Adet Amount within package	10	Gramajı Weight	0,156 kg/m
---	----	-------------------	------------



334

20'lik T Profil
20 T Profile

Paket İçi Adet Amount within package	10	Gramajı Weight	0,265 kg/m
---	----	-------------------	------------



339

Yaylı Yapışkan Profil
Spring Adhesive Profile

Paket İçi Adet Amount within package	10	Gramajı Weight	0,102 kg/m
---	----	-------------------	------------



332

Small T Profil
Small T Profile

Paket İçi Adet Amount within package	10	Gramajı Weight	0,094 kg/m
---	----	-------------------	------------



340

Yaylı Portray Profil
Spring Portray Profile

Paket İçi Adet Amount within package	10	Gramajı Weight	0,076 kg/m
---	----	-------------------	------------



327

Çiftli Orta Profil
Double Middle Profile

Paket İçi Adet Amount within package	10	Gramajı Weight	0,252 kg/m
---	----	-------------------	------------



Alüminyum Renk Seçeneği

Aluminum Color Options

9016

Beyaz
White



Eloksoal Boyalı
Anodized Painted



Bronz Boyalı
Bronze Painted

8003

Altın Meşe
Golden Oak

8016

Maun
Mahogany

7016

Antrasit Gri
Anthracite Gray

Zip Perde

Zip perde sistemleri, dış mekanları veya büyük cam yüzeyleri rüzgar, güneş ışığı ve böcekler gibi dış etkenlere karşı korumak ve kontrol altına almak için kullanılan özel bir pencere kaplama çözümdür. Zip perdeler, aynı zamanda "screen perdeleri" olarak da adlandırılır ve aşağıdaki özelliklere sahiptir:

Zip Blinds

Zip blind systems are a specialized window covering solution used to protect and control outdoor spaces or large glass surfaces from external factors such as wind, sunlight, and insects. Zip blinds are also referred to as "screen blinds" and have the following features:

Fonksiyonellik:

Zip perdeler, güneş ışığına karşı koruma sağlar ve iç mekan sıcaklığını kontrol etmek için kullanılır. Aynı zamanda yağmur, rüzgar ve böcekler gibi dış etkenlere karşı da koruma sunar.

Functionality:

Zip blinds provide protection against sunlight and are used to control indoor temperatures. They also offer protection against external elements like rain, wind, and insects.

Estetik Tasarım:

Zip perdeler, modern ve şık bir görünüme sahiptir. Dikey yönde çalışabilen bir sistemle tasarlanırlar ve bu, farklı pencere türlerine uygunluk sağlar.

Aesthetic Design:

Zip blinds have a modern and stylish appearance and can be designed with a system that operates vertically, making them suitable for various types of windows.

Güneş Işığı Kontrolü:

Zip perdeler, güneş ışığını isteğe bağlı olarak engelleyebilir veya iç mekana geçirilebilir. Bu, iç mekanın aydınlatmasını ve sıcaklığını ayarlamak için kullanışlıdır.

Sunlight Control:

Zip blinds can either block or allow sunlight to enter the interior as desired, making it convenient for adjusting indoor lighting and temperature.

Rüzgar Dayanıklılığı:

Bu perdeler, dayanıklı ve rüzgarlı hava koşullarına karşı dirençli olarak tasarlanır. Rüzgarla temas ettiğinde dengeli ve sabit kalırlar.

Wind Resistance:

These blinds are designed to withstand strong and windy weather conditions, remaining stable even when in contact with the wind.

Kullanım Kolaylığı:

Otomatik kontrol seçenekleri mevcuttur. Otomasyon, kullanım kolaylığı sağlar ve perdelerin istenen pozisyonda sabit kalmasını sağlar.

Ease of Use:

Zip blinds come with automatic options, providing convenience and allowing the blinds to stay in the desired position.

Sineklik İşlevi:

Zip perdeler, açık havada oturma alanları veya teraslar için idealdir. Aynı zamanda sineklik işlevi görebilir ve böceklerin içeri girmesini engelleyebilir.

Insect Protection:

Zip blinds are ideal for outdoor seating areas or terraces, as they can also function as insect screens, preventing bugs from entering.

Uzun Ömür:

Kaliteli malzemelerle yapıldığında, zip perdeler uzun yıllar boyunca dayanıklılık ve performans sunabilirler.

Longevity:

When made from high-quality materials, zip blinds can offer durability and long-lasting performance.



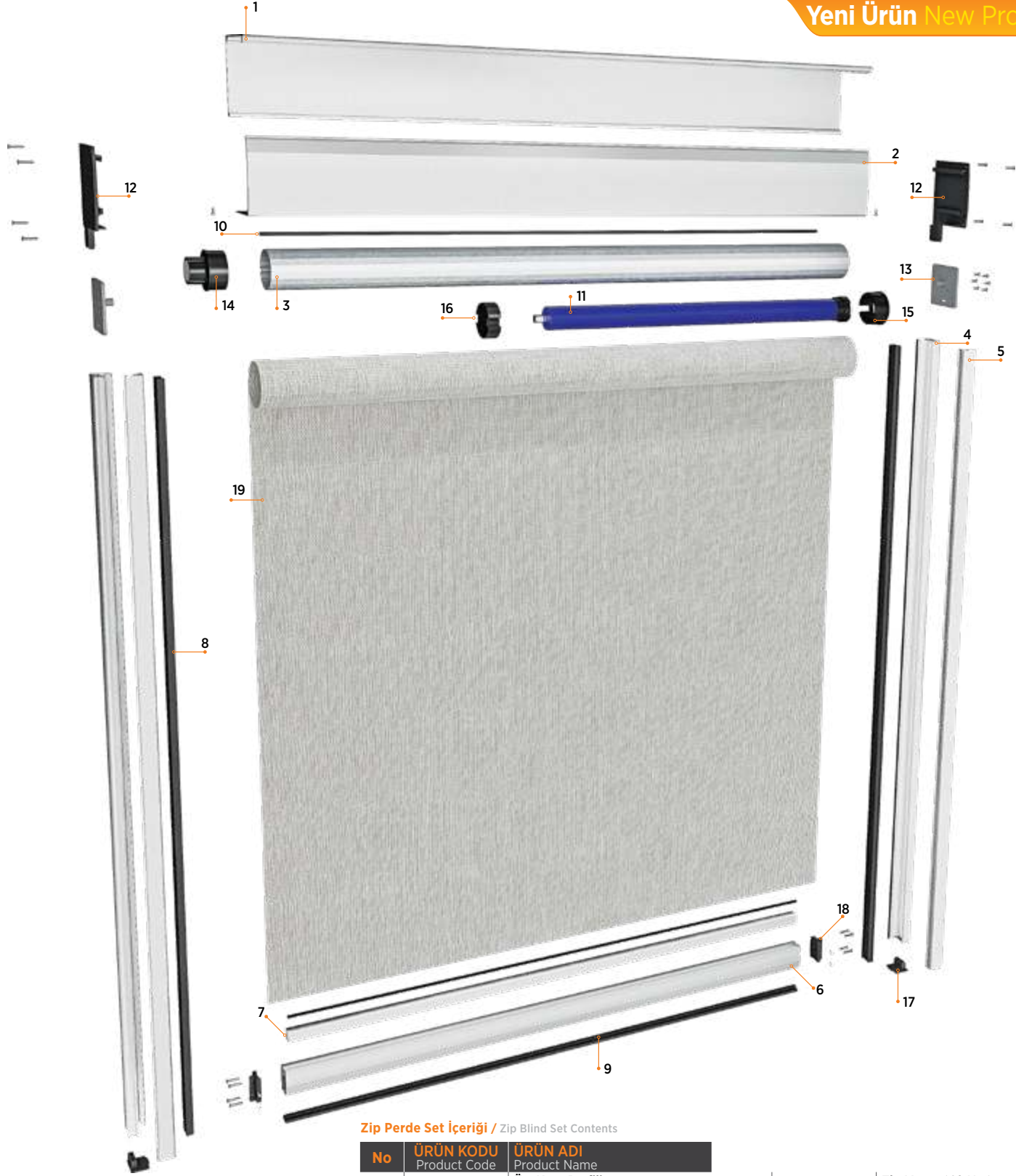

Zip Perde Set İçeriği / Zip Blind Set Contents

No	ÜRÜN KODU Product Code	ÜRÜN ADI Product Name
1	7150	Üst Kasa Profili Upper Case Profile
2	7151	Üst Kasa Kapak Profili Upper Case Cover Profile
3	ZP 13	Sac Tambur Borusu Sheet Drum Tube
4	251	Yan Kasa Profili Side Case Profile
5	252	Yan Kasa Kapak Profili Side Case Cover Profile
6	250	Kanat Profili Wing Profile
7	ZP 15	5x20 Lama Demir 5x20 Blade Iron
8	ZP 09	Fermuar Aparatı Zipper Apparatus
9	ZP 10	Kanat Contası Wing Seal
10	ZP 11	Perde Plastiği Curtain Plastic

11	ZP 12	Zip Motor (40 Nm) Zip Engine 40 Nm
12	ZP 01	Üst Kasa Kapak - Sağ/Sol Upper Case Cover - Right/Left
13	ZP 02	Çelik Pimli Motor Bağlantı Parçası Steel Pinned Motor Connection Part
14	ZP 03	Rulmanlı Tambur Bağlantı Bearing Drum Connection
15	ZP 04	Motorlu Tambur Bağlantı Motorized Drum Connection
16	ZP 05	Rotor Aktarma Parçası Rotor Transmission Part
17	ZP 06	Yan Kasa Kapakları - Sağ/Sol Side Case Covers - Right/Left
18	ZP 07	Kanat Kapakları Wing Covers
19	-	Zip Perde Zip Blind

Zip perdeler, özellikle evler, restoranlar, kafeler, oteller ve ticari binalar gibi birçok farklı mekan için popüler bir seçenektir. Bu perdeler, iç mekan konforunu artırmak ve enerji tasarrufu sağlamak için kullanışlıdır.

Zip blinds are a popular choice for various settings, including homes, restaurants, cafes, hotels, and commercial buildings. They are useful for enhancing indoor comfort and promoting energy efficiency.

ALÜMİNYUM PROFİL GRUBU

Aluminium Profile Group

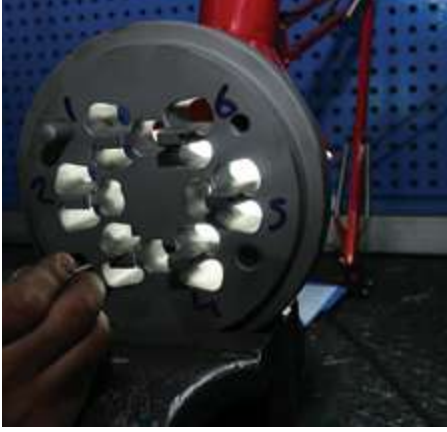

ISO 9001 | ISO 14001 | OHSAS 18001

GOLD SERİ PLİSE SİNEKLİK / GOLD SERIES PLAİT FLY SCREEN

304

0,318 kg/m

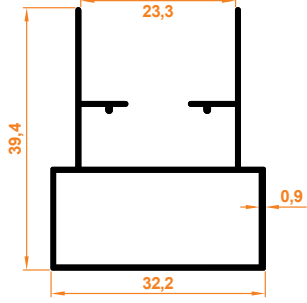

Gold Kasa Profil
Gold Case Profile

305

0,330 kg/m

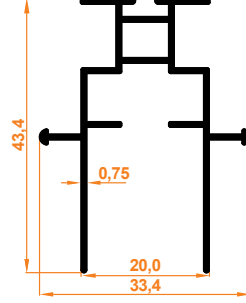

Gold Kanat Profil
Gold Wing Profile

STAR SERİ PLİSE SİNEKLİK / STAR SERIES PLAİT FLY SCREEN

302

0,272 kg/m

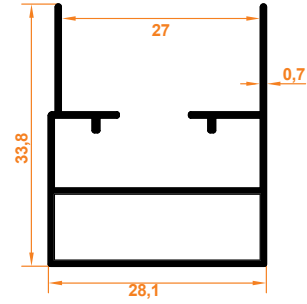

Star Kasa Profil
Star Case Profile

301

0,303 kg/m

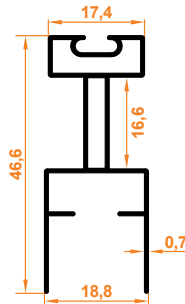

Star Kanat Profil
Star Wing Profile

JUNIOR SERİ PLİSE SİNEKLİK / JUNIOR SERIES PLAİT FLY SCREEN

306

0,243 kg/m

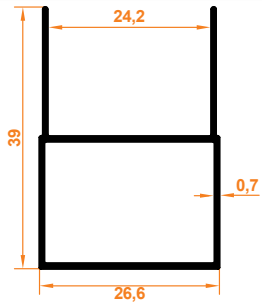

Junior Kasa Profil
Junior Case Profile

307

0,304 kg/m

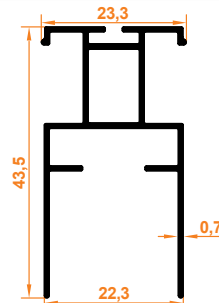

Junior Kanat Profil
Junior Wing Profile

345

0,162 kg/m

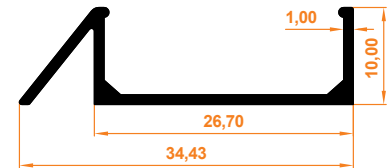

Junior Eşiksiz Kasa Profil
Junior Case Profile without Threshold

SLIM SERİ PLİSE SİNEKLİK / SLIM SERIES PLAİT FLY SCREEN

300

0,218 kg/m

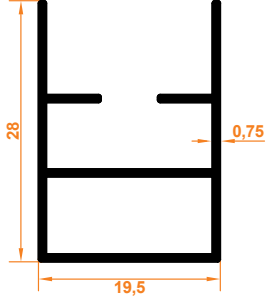

Slim Kasa Profil
Slim Case Profile

301

0,303 kg/m

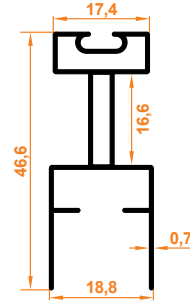

Slim Kanat Profil
Slim Wing Profile

331

0,168 kg/m



Slim Eşiksiz Profil
Slim Profile without Threshold

NOBEL SERİ PLİSE SİNEKLİK / NOBEL SERIES PLAİT FLY SCREEN

335

0,345 kg/m

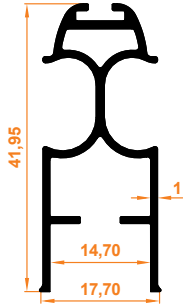

Nobel Kanat Profili
Nobel Wing Profile

336

0,148 kg/m

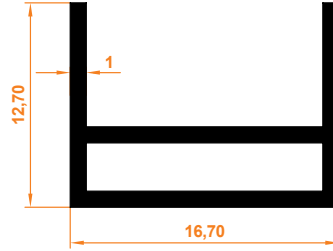

Nobel Eşiksiz Kasa Profili
Nobel Case Profile without Threshold

338

0,250 kg/m

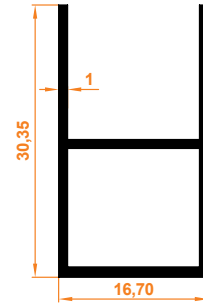

Nobel Kasa Profili
Nobel Case Profile

SÜPER SERİ PLİSE SİNEKLİK / SUPER SERIES PLAİT FLY SCREEN

316

0,248 kg/m

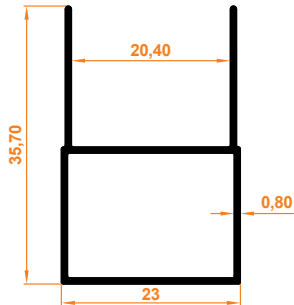

Süper Seri Kasa Profili
Super Case Profile

320

0,303 kg/m

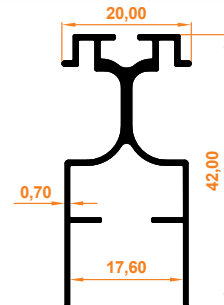

Süper Seri Kanat Profili
Super Wing Profile

325

0,469 kg/m

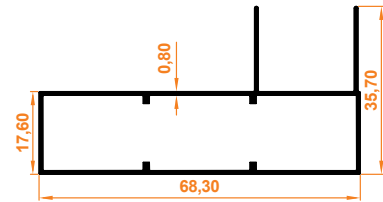

Süper Büyük Kasa Profili
Super Big Case Profile

NOBEL SERİ İÇTEN MONTAJLI PLİSE SİNEKLİK / NOBEL SERIES INTERNAL MOUNTED PLAIT FLY SCREEN

337

0,338 kg/m

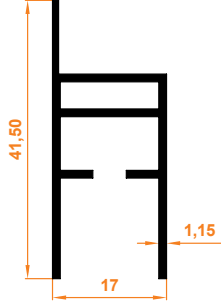

Nobel İçten Montajlı Kasa Profili
Nobel Internal Mounted Case Profile

335

0,345 kg/m

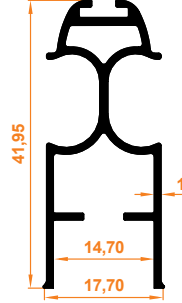

Nobel Kanat Profili
Nobel Wing Profile

SLIM SERİ İÇTEN MONTAJLI PLİSE SİNEKLİK / SLIM SERIES INTERNAL MOUNTED PLAIT FLY SCREEN

317

0,272 kg/m

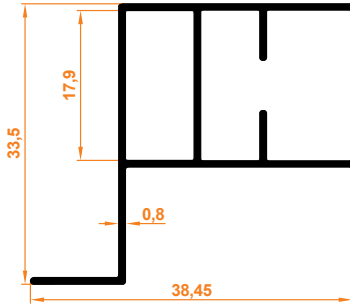

Kasa Profil
Case Profile

301

0,303 kg/m

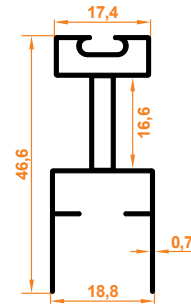

Kanat Profil
Wing Profile

İÇTEN MONTAJLI SABİT SİNEKLİK / INTERNAL MOUNTED FIXED FLY SCREEN

405

0,256 kg/m

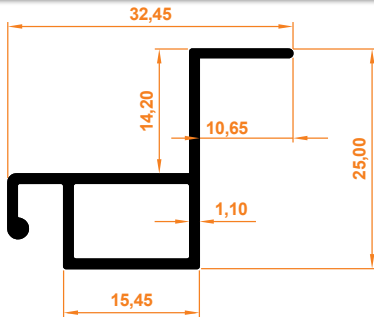

Kasa Profili
Case Profile

AYKİM SERİ SİNEKLİK / AYKİM SERIES FLY SCREEN

309

0,374 kg/m

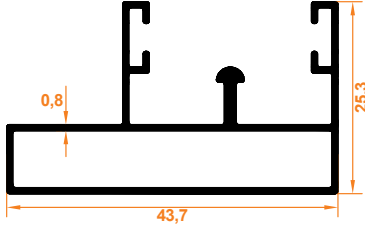

Aykim Kasa Profil
Aykim Case Profile

310

0,315 kg/m

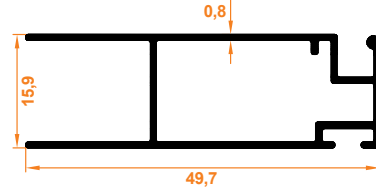

Aykim Hareketli Profil
Aykim Sliding Profile

PLATİN SERİ SİNEKLİK / PLATİN SERIES FLY SCREEN

321

0,352 kg/m

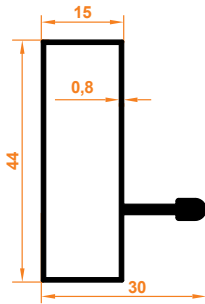

Platin Tekli Kasa Profil
Platin Single Case Profile

322

0,455 kg/m

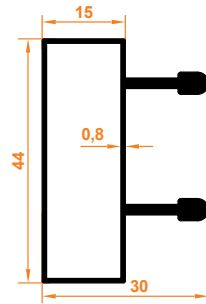

Platin Çiftli Kasa Profil
Platin Double Case Profile

323

0,506 kg/m

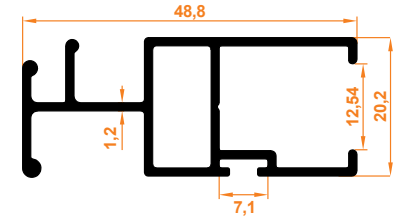

Platin Kanat Profil
Platin Wing Profile

DÜZ SİNEKLİK PROFİL GRUBU
Flat Fly Screen Profile Group

400

0,105 kg/m

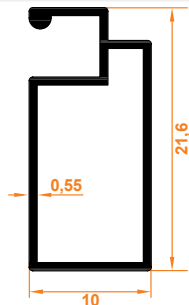

10x20 Sineklik
10x20 Fly Screen

401

0,142 kg/m

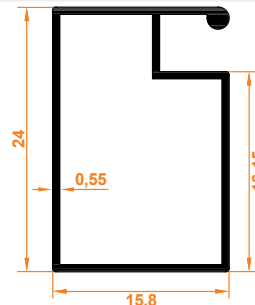

17x25 Sineklik
17x25 Fly Screen

402

0,250 kg/m

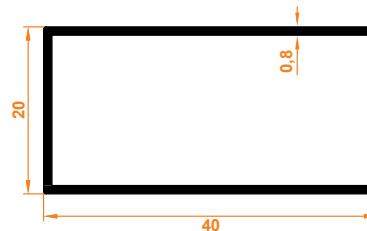

20x40 Sineklik
20x40 Fly Screen

311

0,304 kg/m

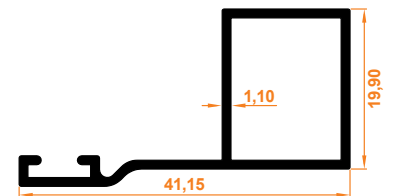

İçe Açılır Fitilli Sineklik Profili
Inward Foldable Flyscreen Profile

STOR SİNEKLİK PROFİL GRUBU

Stor Fly Screen Profile Group

407

0,342 kg/m

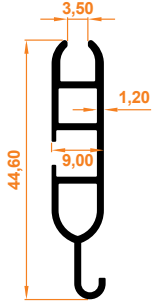

Stor Kanat Profil
Stor Wing Profile

408

0,286 kg/m

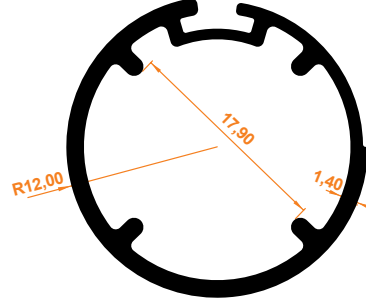

Stor Boru Profil
Stor Pipe Profile

409

0,526 kg/m

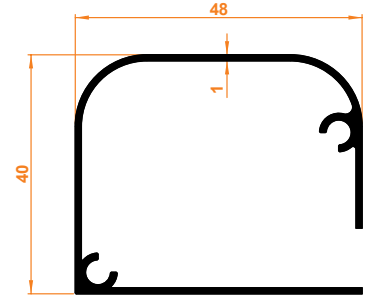

Stor Kasa Profil
Stor Case Profile

410

0,413 kg/m

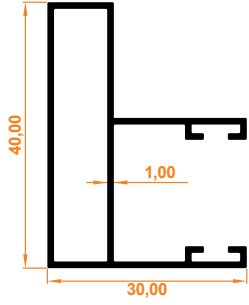

Stor Yan Kasa Profil
Stor Side Case Profile

411

0,318 kg/m

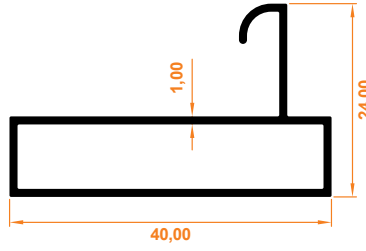

Stor Alt Kasa Profil
Stor Bottom Case Profile

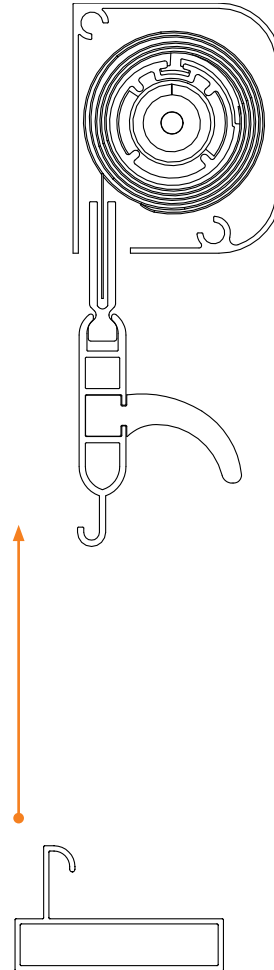
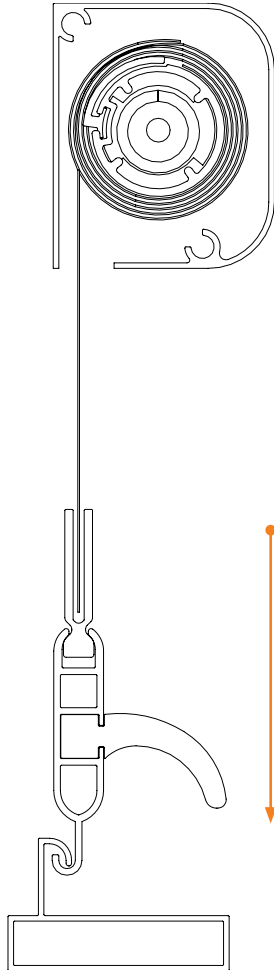

1

0,247 kg/m

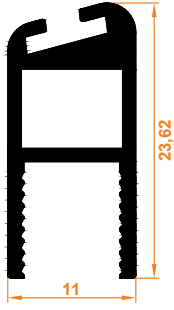

Büyük D Fitol
Big D Wick

2

0,167 kg/m

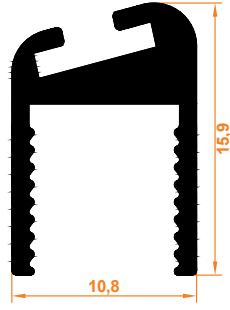

Küçük D Fitol
Small D Wick

3

0,116 kg/m

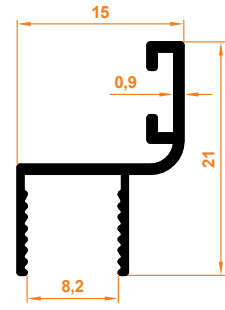

Küçük h Fitol
Small h Wick

4

0,150 kg/m

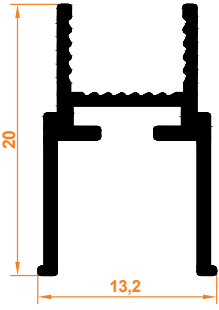

Orta H Fitol
Middle H Wick

5

0,214 kg/m

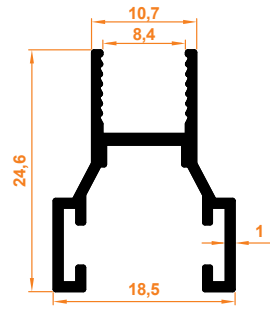

Büyük H Fitol
Big H Wick

6

0,276 kg/m

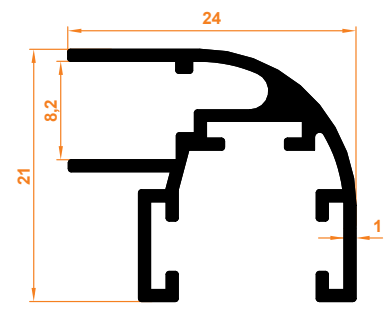

Köşe Dönüş Fitol
Corner Return Wick

8 mm CAM BALKON PROFİL GRUBU

8 mm Glass Balcony Profile Group

101

0,078 kg/m

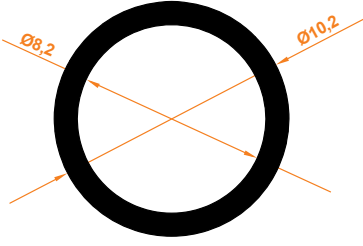

10'lu Stoplama
10 Stopping Profile

104

0,717 kg/m

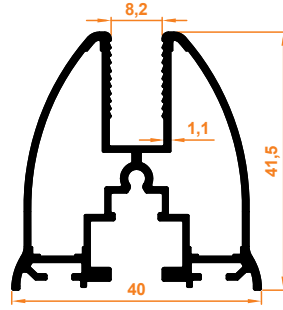

Gold Baza
Gold Base

105

0,730 kg/m

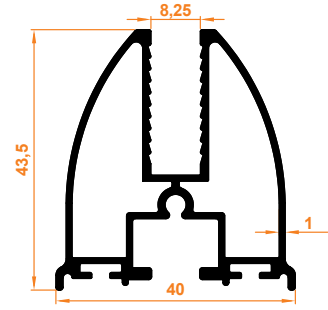

Firtina Baza
Firtina Base

109

1,355 kg/m

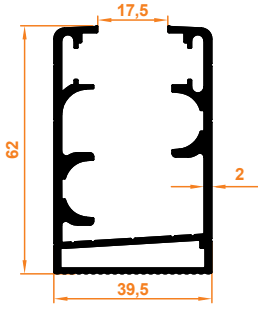

Düz Kasa Profil
Flat Case Profile

110

1,396 kg/m

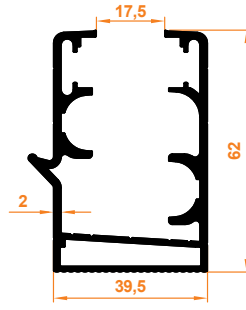

Oluklu Kasa Profil
Corrugated Case Profile

100

0,441 kg/m

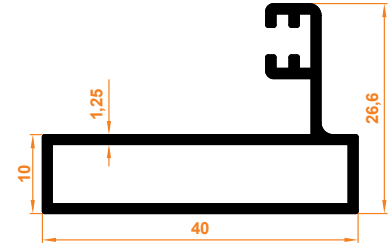

Dar Yan Dikme
Thin Side Column

106

1,611 kg/m

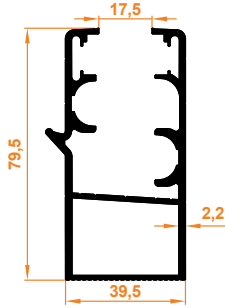

Oluklu Büyük Kasa Profil
Corrugated Big Case Profile

107

1,570 kg/m

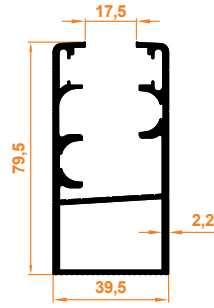

Büyük Düz Kasa Profil
Big Flat Case Profile

108

0,457 kg/m

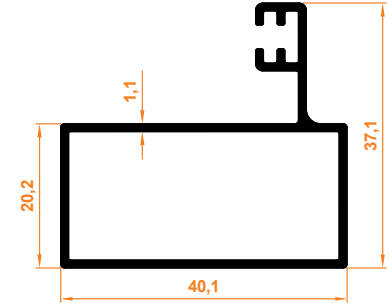

Geniş Yan Dikme
Thick Side Column Profile

111

1,062 kg/m

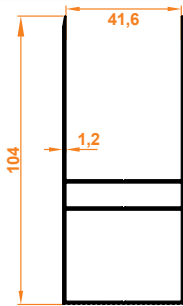

Stor Profil
Stor Profile

135

0,517 kg/m

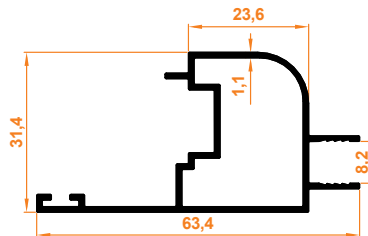

8 mm İspanyolet Profil
8 mm Espagnolette Profile

136

0,343 kg/m

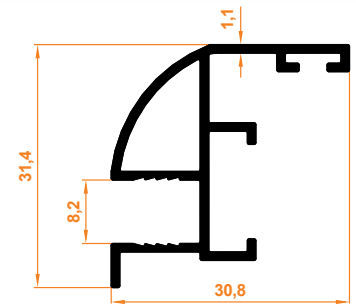

8 mm İspanyolet Profil Karşılığı
8 mm Espagnolette Combination Profile

800

0,618 kg/m

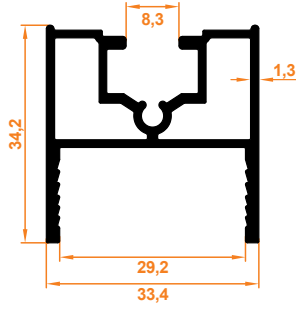

Baza Profil
Base Profile

801

0,321 kg/m

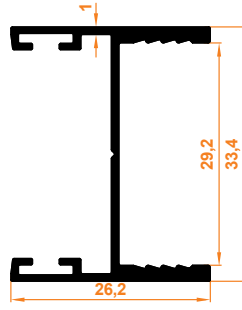

Düz Kapak Profil
Flat Cover Profile

802

0,327 kg/m

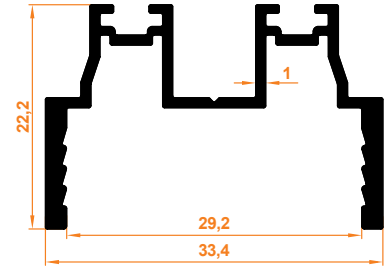

Düz Kapak Menteşe Profil
Flat Cover with Hinge Profile

803

0,445 kg/m

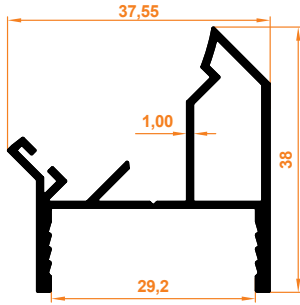

45° Dönüş Profil
45° Return Profile

804

0,378 kg/m

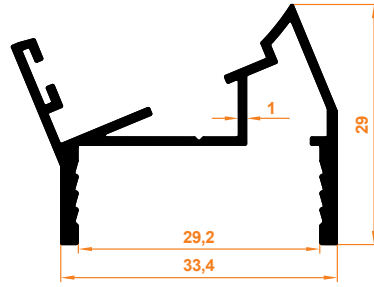

22,5° Dönüş Profil
22,5° Return Profile

805

0,366 kg/m

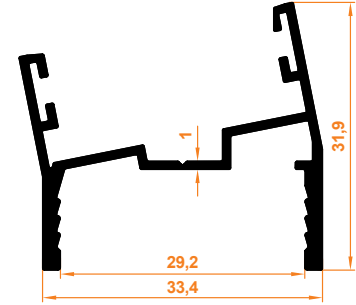

11° Dönüş Profil
11° Return Profile

806

0,475 kg/m

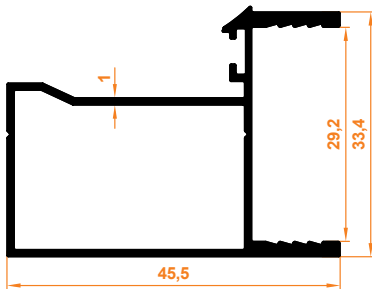

90° Dönüş Profil
90° Return Profile

807

0,346 kg/m

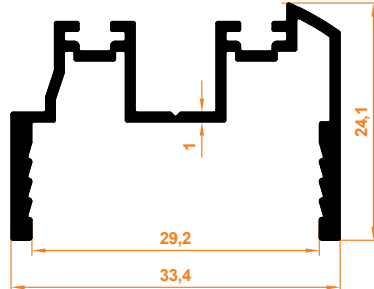

Açılı Dönüş Menteşe Profil
PopUp Return Hinge Profile

808

0,369 kg/m

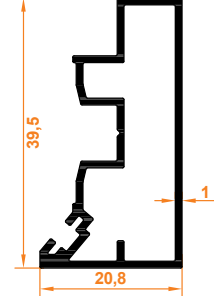

Yan Dikme Profil
Side Column Profile

809

0,328 kg/m

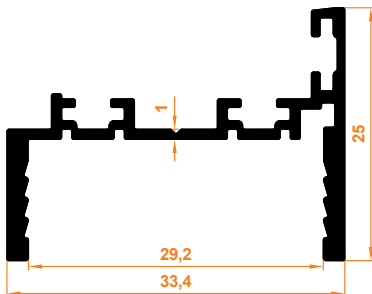

Sabit Cam Menteşe Profil
Stable Glass Hinge Profile

810

0,355 kg/m

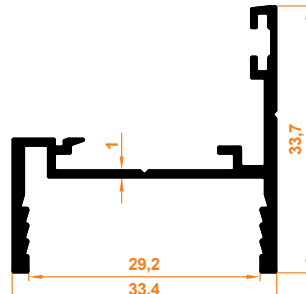

Sabit Cam Kilit Profil
Stable Glass Lock Profile

811

0,342 kg/m

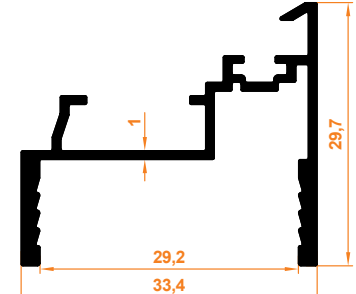

Sabit Cam Kilit Karşılığı Profil
Stable Glass Lock Prevention Profile

819

1,344 kg/m

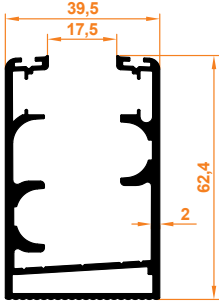

Düz Kasa Üstten Fitilli Profil
Flat Case Top Wicked Profile

820

1,389 kg/m

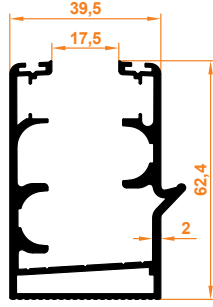

Oluklu Kasa Üstten Fitilli Profil
Corrugated Case Top Wicked Profile

822

0,378 kg/m

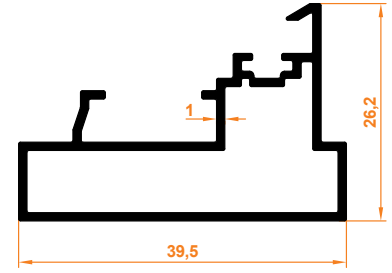

Açılır Dikme Profil
PopUp Column Profile

816

1,577 kg/m

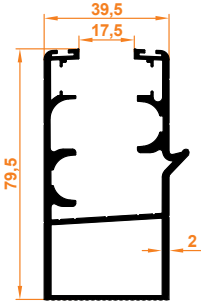

Üstten Fitilli Büyük Oluklu Kasa
Large Corrugated Case with Top Wick

817

1,532 kg/m

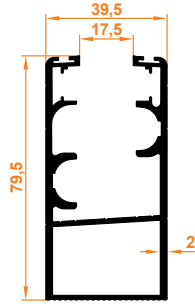

Üstten Fitilli Büyük Düz Kasa
Large Flat Case with Wed from Top

815

0,100 kg/m

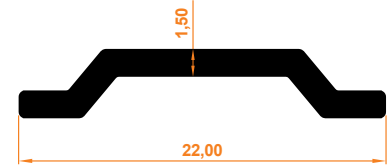

Tij Profil
Espagnolette Profile

823

0,459 kg/m

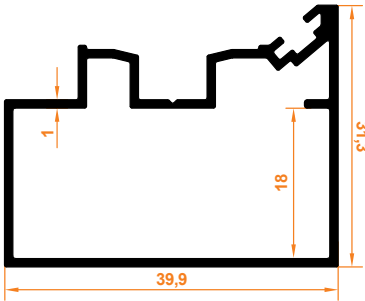

Geniş Yan Dikme
Wide Side Column

824

0,583 kg/m

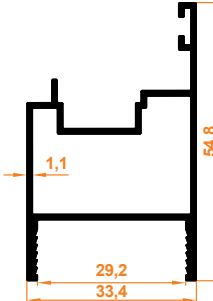

Sabit Cam İspanyolet Profil
Fixed Glass Espagnolette Profile

825

0,356 kg/m

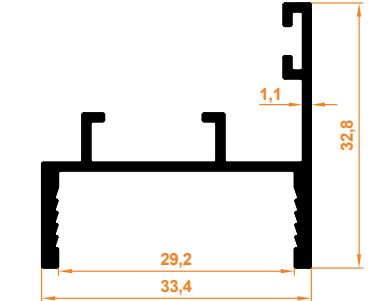

Sabit Cam İspanyolet Karşılık Profil
Fixed Glass Espagnolette Handle Provision Profile

210

0,643 kg/m

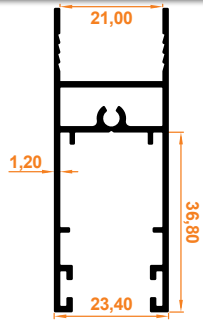

Sürme Baza Profil
Sliding Base Profile

215

0,908 kg/m

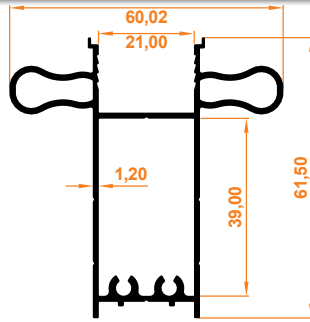

Çekme Kol Profil
Pull Handle Profile

212

0,423 kg/m

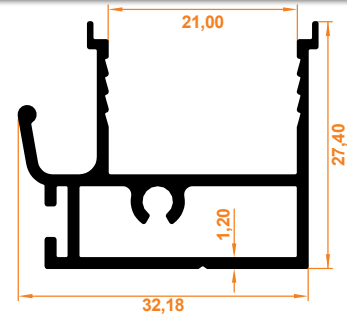

Kenet Profil
Clamp Profile

211

0,301 kg/m

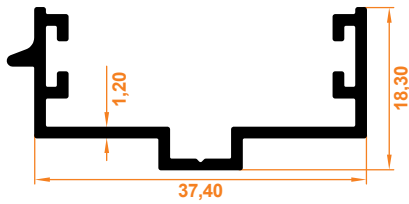

Birleştirme Karşılık Profil
Combination Provisions Profile

213

0,974 kg/m

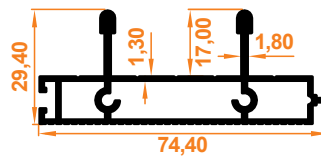

İkili Eşikli Alt Kasa Profil
Double Threshold Lower Case Profile

222

1,333 kg/m

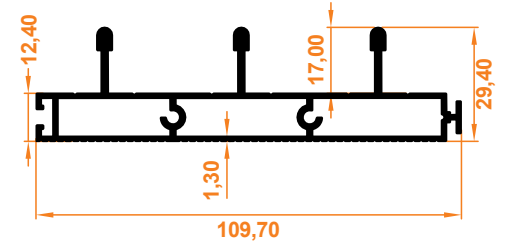

Üçlü Eşikli Alt Kasa Profil
Triple Threshold Lower Case Profile

220

0,867 kg/m

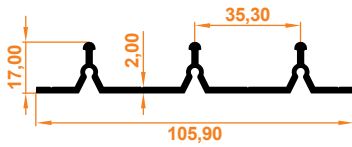

Üçlü Eşiksiz Alt Kasa Profil
Triple Bottom Case Profile without Threshold

229

1,120 kg/m

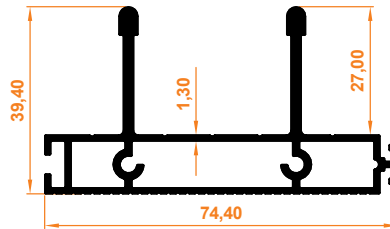

İkili Üst Kasa Profil
Double Upper Case Profile

230

1,552 kg/m

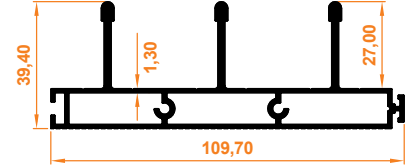

İkili Üçlü Kasa Profil
Triple Upper Case Profile

221

1,156 kg/m

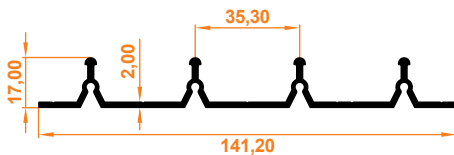

Dörtlü Eşiksiz Alt Kasa Profil
Quadruple Bottom Case Profile without Threshold

214

0,587 kg/m

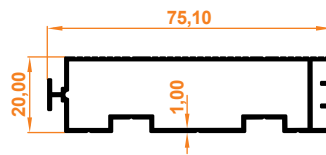

İkili Yan Kasa Profil
Double Side Case Profile

223

0,792 kg/m

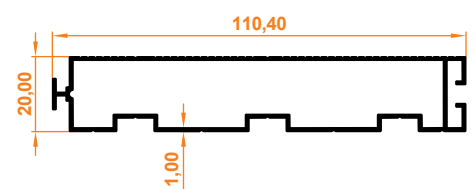

Üçlü Yan Kasa Profil
Triple Side Case Profile

219

0,219 kg/m

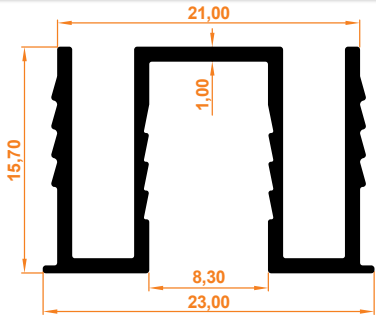

8 mm Cam Adaptörü
8mm Glass Adapter

226

0,071 kg/m

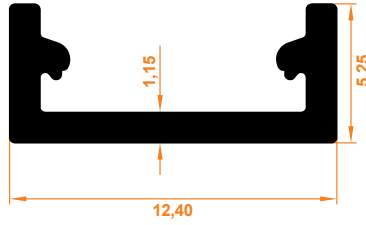

Kapatma Profil
Closing Profile

227

0,957 kg/m

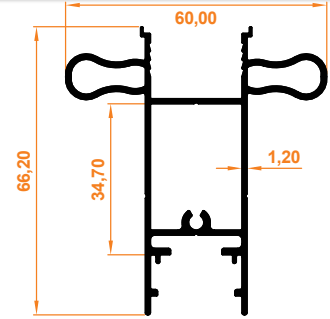

İspanyolet Çekme Kol Profili
Espagnolette Pull Handle Profile

228

0,156 kg/m

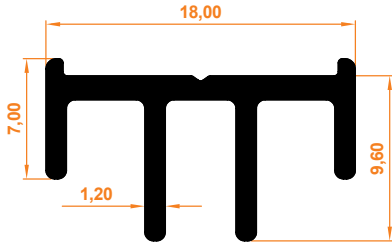

İspanyolet Karşılık Profili
Espagnolette Provision Profile

Sürme Sistem Çalışma Mekanizması

Sliding System Operating Mechanism

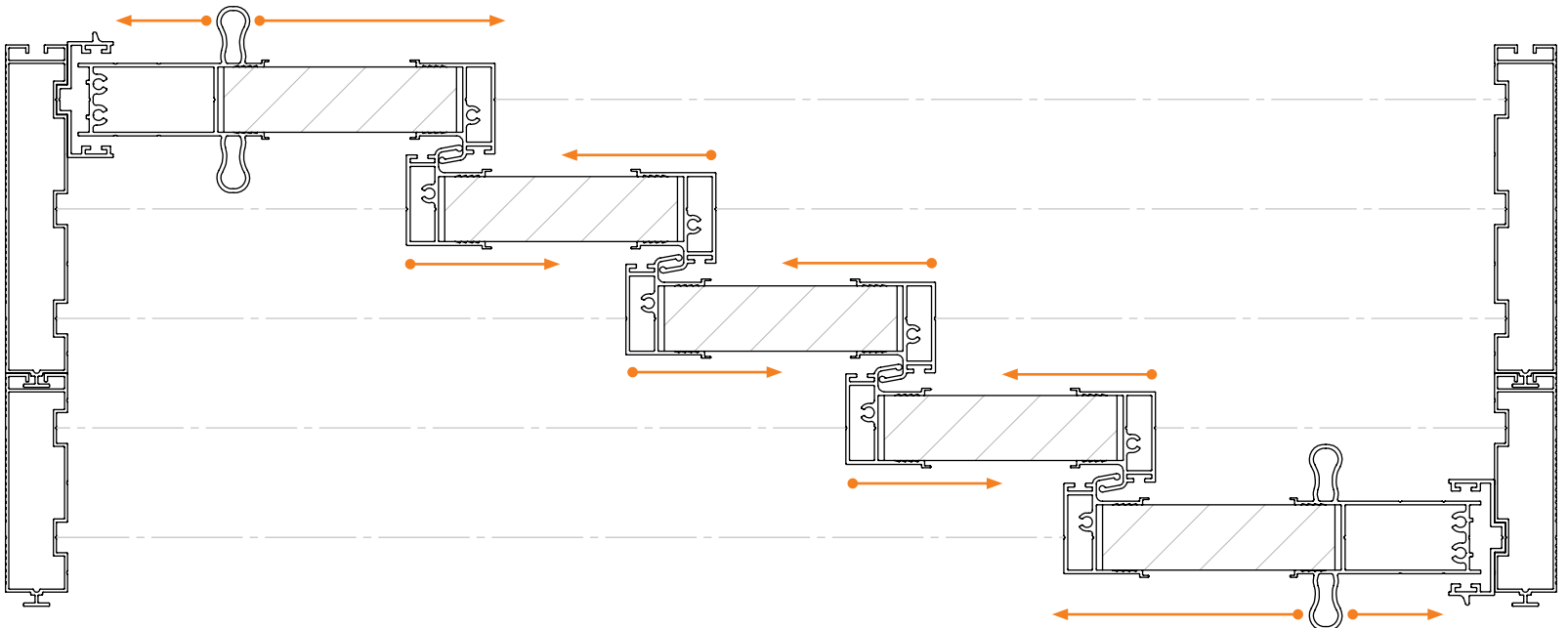

Sürme Sistem Çalışma Mekanizması

Sliding System Operating Mechanism

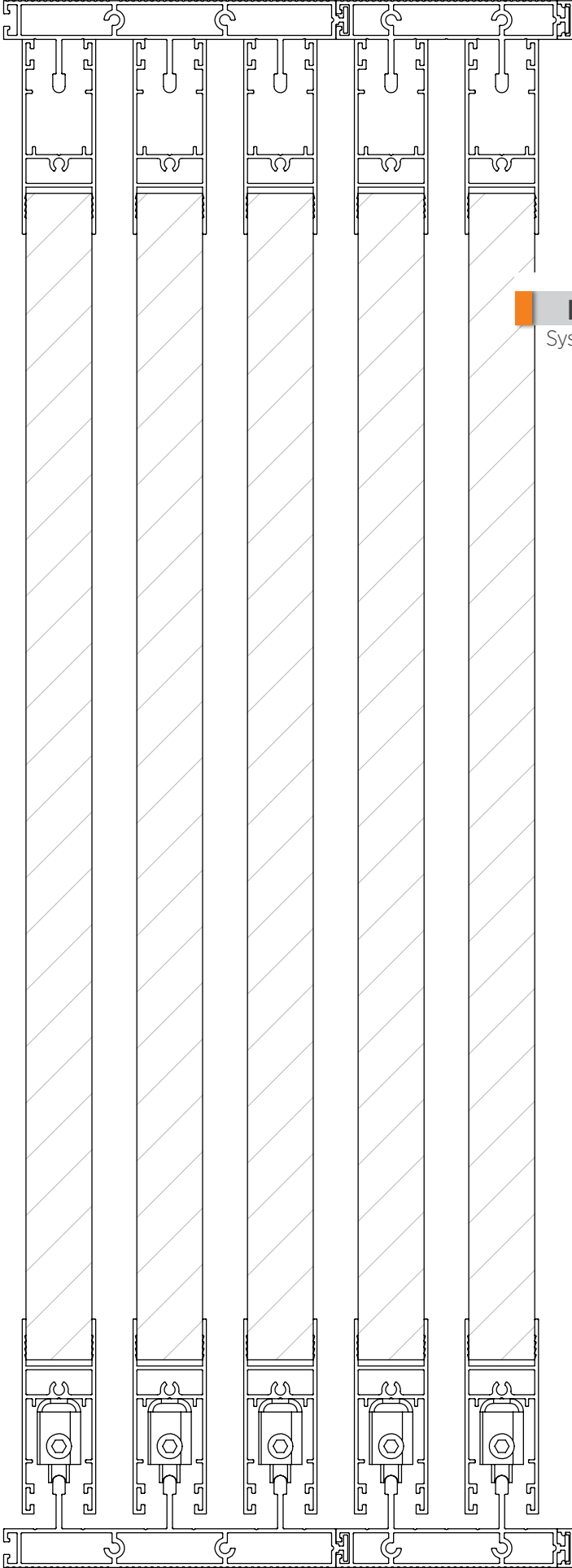

Eşikli Sistem

System with Treshold

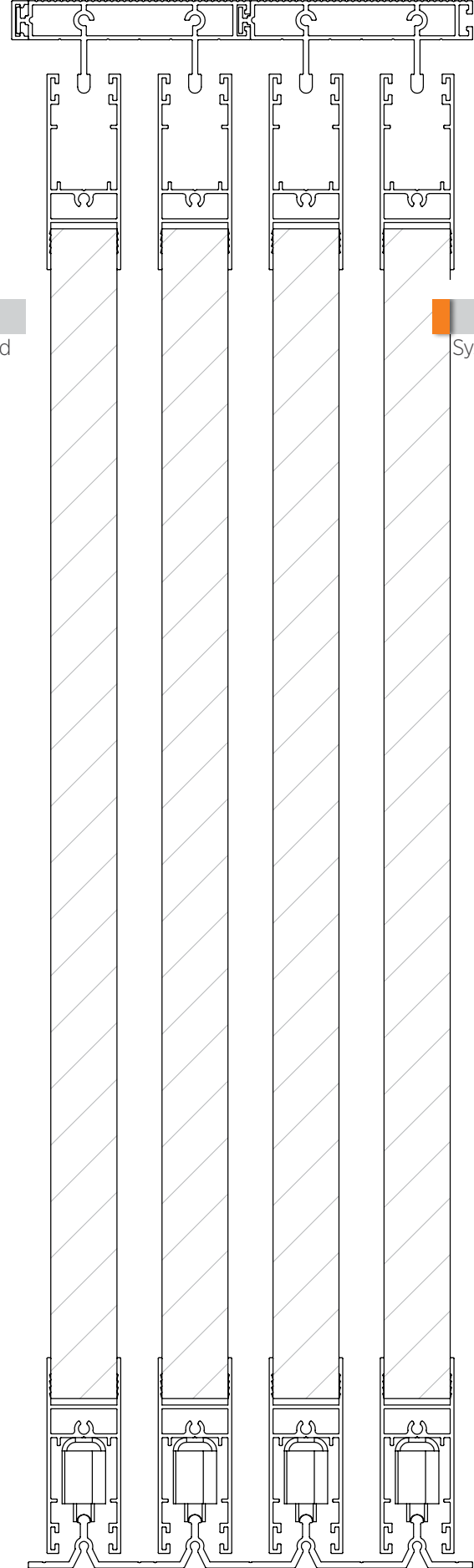

Eşiksiz Sistem

System without Treshold

140

0,563 kg/m

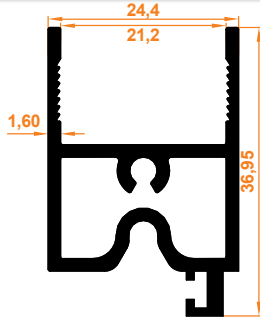

Sabit Panel Açılır Alt Baza Profil
Fixed Panel Pop-up Base Profile

164

0,842 kg/m

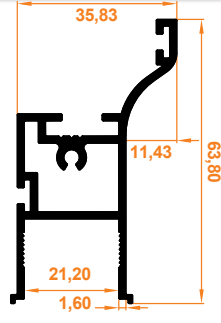

Sabit Panel Yan Dikme Profil
Fixed Panel Side Column Profile

142

0,750 kg/m

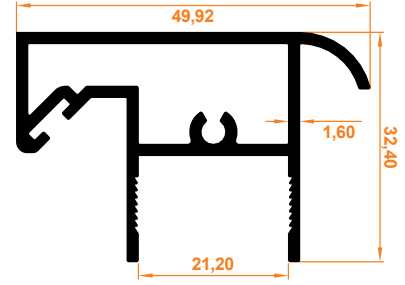

Sabit Panel Üst Baza Profil
Fixed Panel Top Base Profile

167

1,144 kg/m

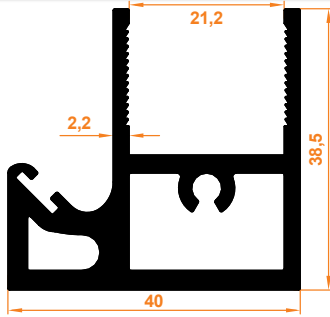

Kenet Baza Profil
Clamp Base Profile

144

0,434 kg/m

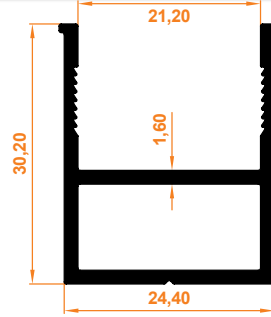

Hareketli Panel Yan Dikme Profil
Movable Panel Side Column Profile

145

0,579 kg/m

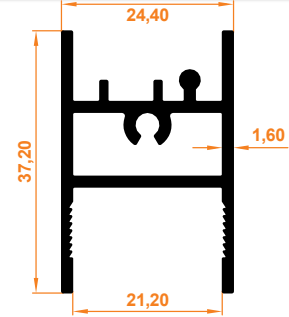

Küpeşte Baza Profil
Handrail Base Profile

146

0,741 kg/m

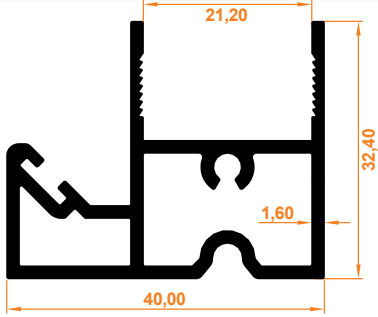

Hareketli Panel Açılır Alt Baza Profil
Movable Panel Pop-up Lower Base Profile

161

0,482 kg/m

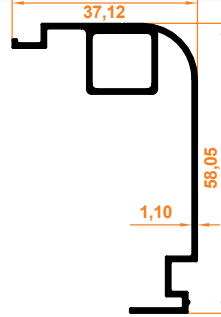

Ray Kapatma "T" Profil
Rail Closure "T" Profile

160

1,057 kg/m

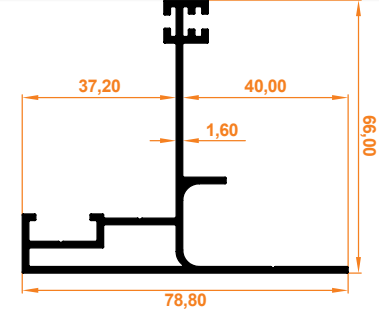

Yan Ray "T" Profil
Side Rail "T" Profile

166

0,144 kg/m



Açılımlı için Ray Kapatma 'L' Profil
Rail Closure 'L' Profile for Opening

162

0,703 kg/m

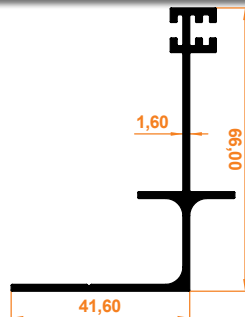

Yan Ray "L" Profil
Side Rail "L" Profile

GYT 28

2,110 kg/m

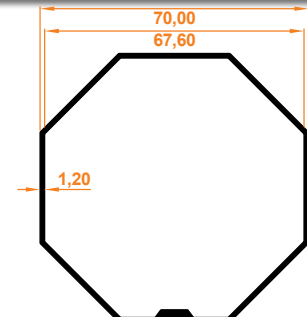

Sac Tambur Borusu
Sheet Drum Pipe

152

1,563 kg/m

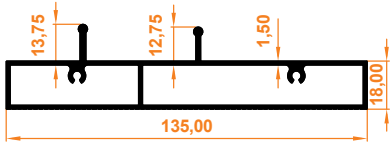

Alt Kasa
Guillotine Lower Case Profile

156

3,449 kg/m

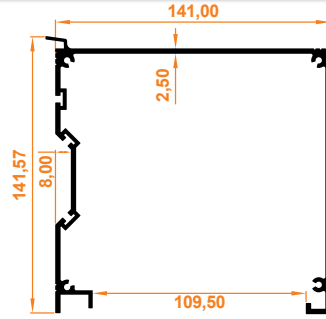

Üst Kasa Profil
Top Case Profile

153

0,864 kg/m

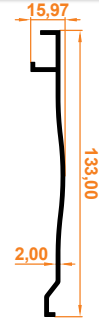

Üst Kasa Kapak Profil
Top Case Cover Profile

155

1,669 kg/m

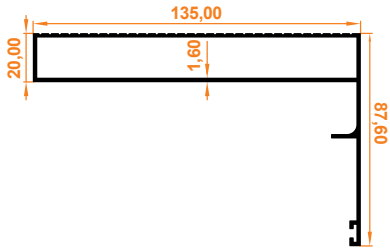

Yan Kasa Profil
Side Case Profile

154

0,759 kg/m

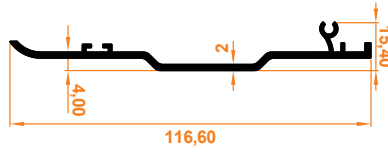

Küpeşte Profil
Handrail Profile

165

0,644 kg/m



Yan Kasa Kertme Profil
Side Case Notched Profile

158

0,510 kg/m

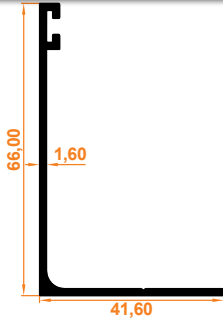

Açılımsız Tek Fıtil Yan Ray L Kasa Profil
Single Weatherstrips Without Opening Side L Case Profile

159

0,660 kg/m

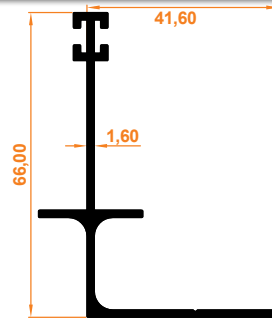

Açılımsız Çift Fıtil Yan Ray L Kasa Profil
Double Weatherstrips Without Opening Side L Case Profil

219

0,219 kg/m

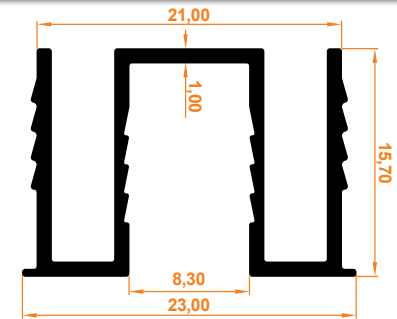

8 mm Cam Adaptörü
8mm Glass Adapter

149

0,162 kg/m

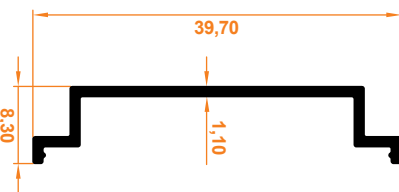

Açılımsız için Ray Kapatma 'L' Profil
Rail Closure 'L' Profile for Non-Opening

Giyotin Sistem Çalışma Mekanizması

Guillotine System Operating Mechanism

1. Kademe - Level 1

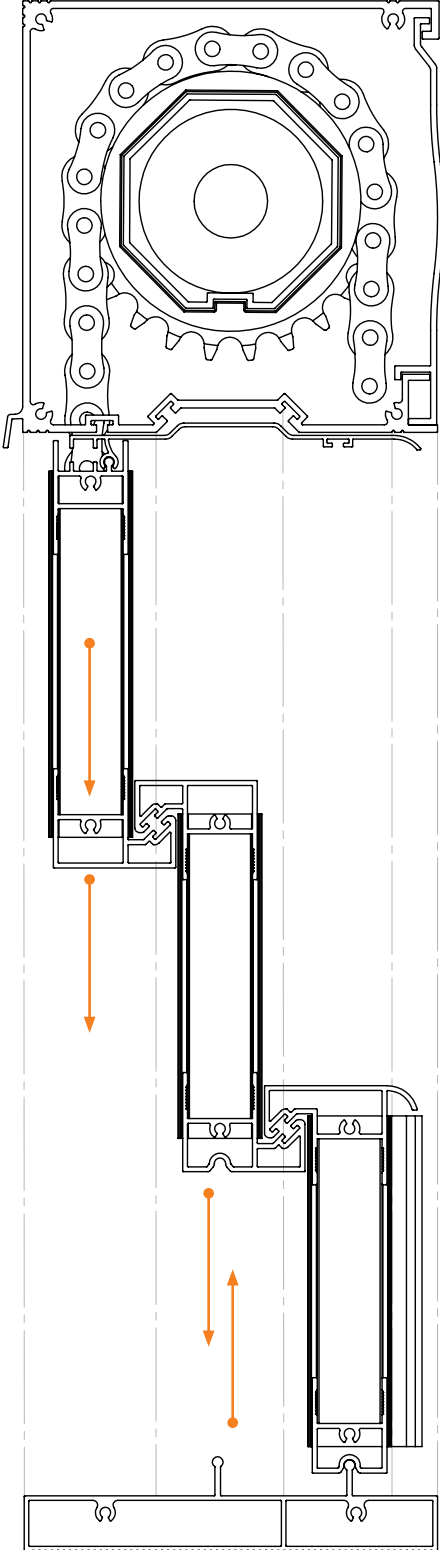

2. Kademe - Level 2

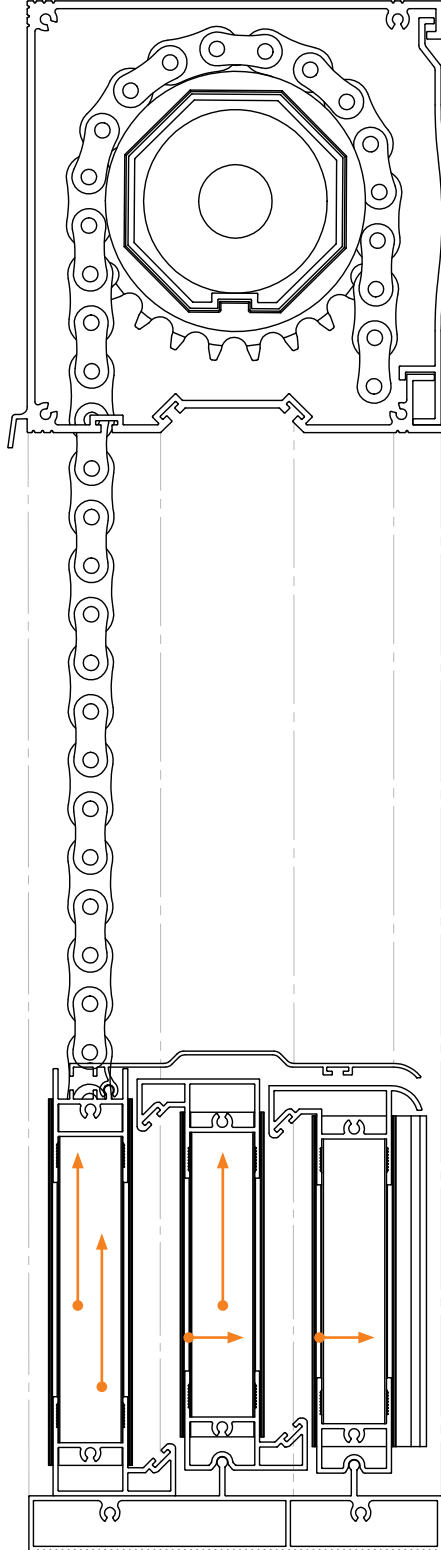

3. Kademe - Level 3

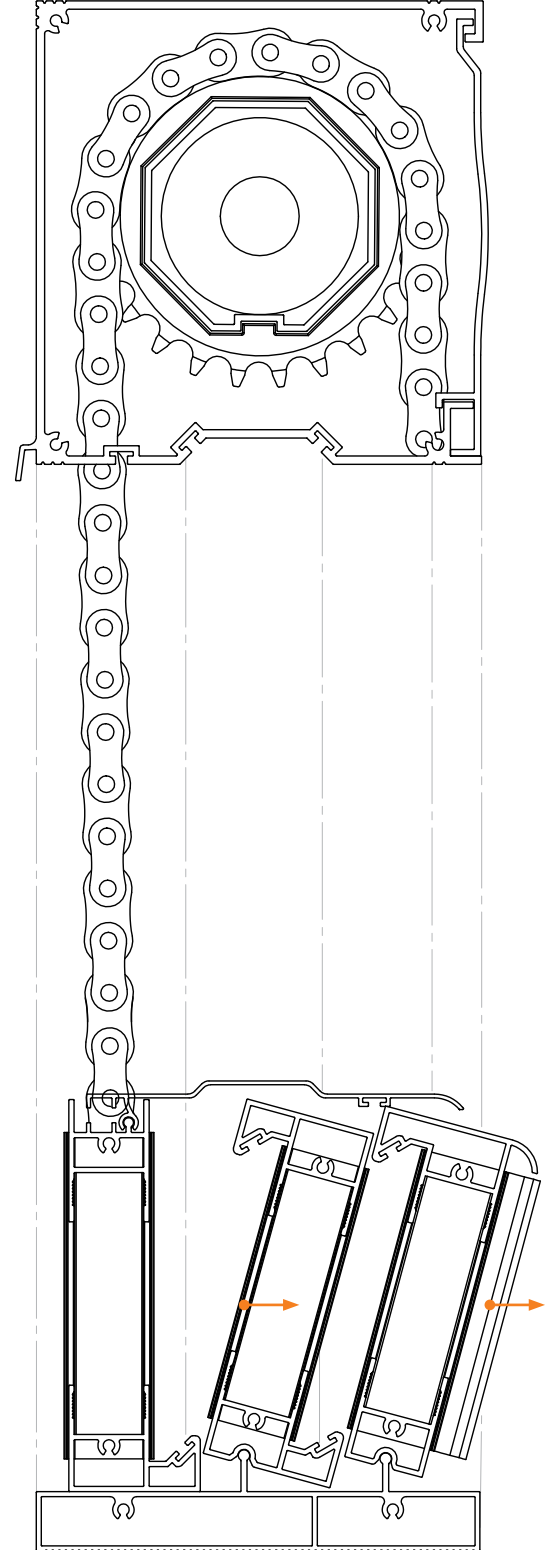

417

0,467 kg/m

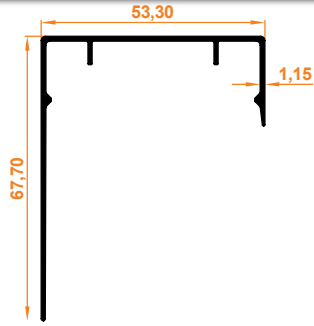

Sonlandırıcı Cam Çıta Kapak Profili
End Cap Glass Strip Cover Profile

418

0,329 kg/m

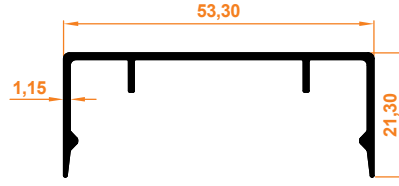

Cam Çıta Kapak Profili
Glass Strip Cover Profile

419

2,100 kg/m

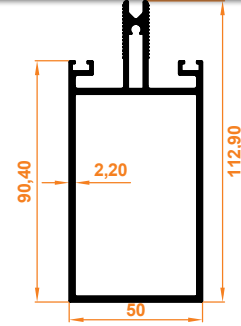

Orta Kayıt Profili
Center Mullion Profile

420

0,682 kg/m

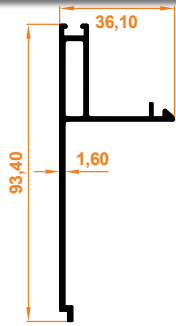

Kasa Kapatma Profili
Frame Closure Profile

421

3,184 kg/m

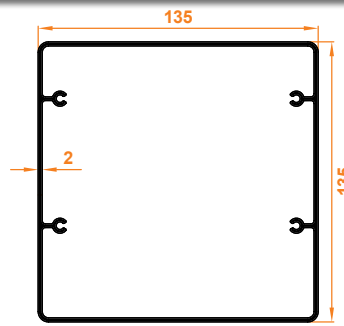

Ayak Profili
Leg Profile

422

4,318 kg/m

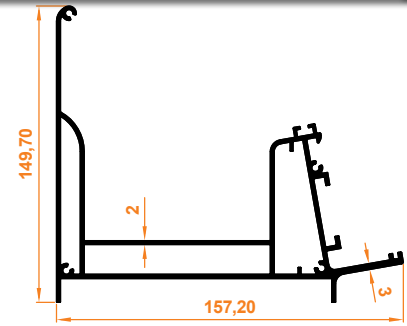

Oluk Profili
Groove Profile

423

3,142 kg/m

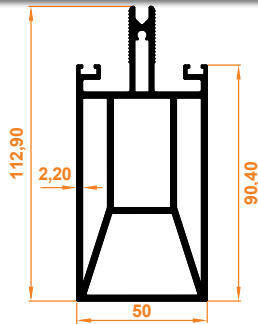

Destekli Orta Kayıt Profili
Reinforced Center Mullion Profile

424

2,835 kg/m

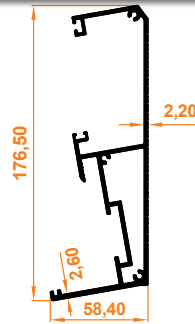

Duvar Kasa Profili
Wall Frame Profile

425

0,847 kg/m

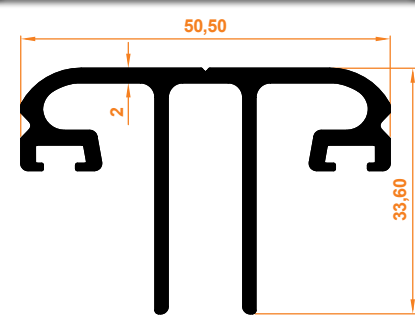

Cam Çıta Profili
Glass Strip Profile

426

3,434 kg/m

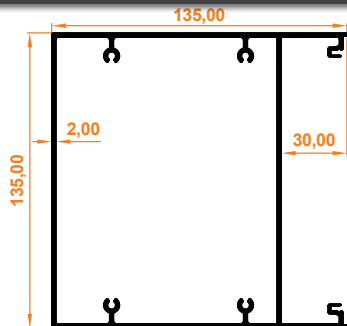

Gizli Ayak Profili
Hidden Leg Profile

427

2,271 kg/m

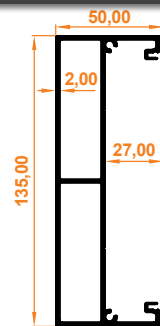

Destek Kutu Profili
Reinforcing Box Profile

428

0,501 kg/m

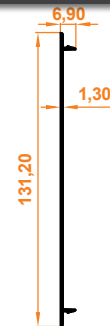

Gizli Ayak ve Destek Kutu Kapatma Profili
Hidden Leg Case Cover Support Profile

C60 SERİ ALÜMİNYUM PROFİL GRUBU

C60 Series Aluminum Profile Group

7100

0,921 kg/m

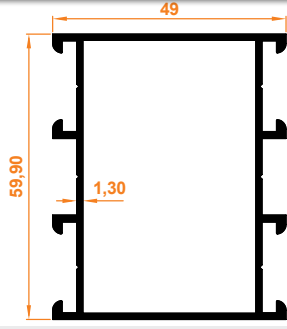

C60 Kasa Orta Kayıt Profili
C60 Case Mid Entry Profile

7101

0,988 kg/m

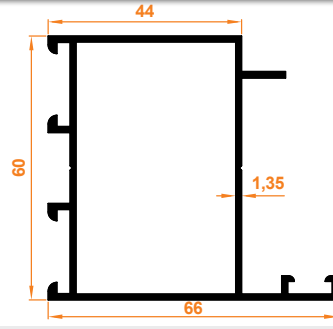

C60 Kanat Profili
C60 Wing Profile

7102

1,440 kg/m

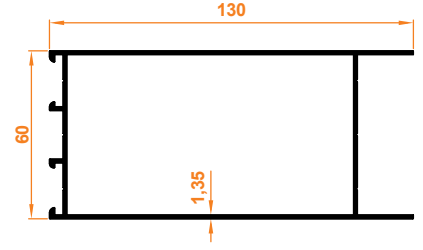

C60 Etek Profili
C60 Skirt Profile

7103

1,099 kg/m

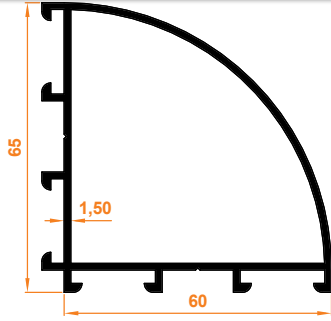

C60 Oval Köşe Dönüş Profili
C60 Oval Corner Profile

7104

0,436 kg/m

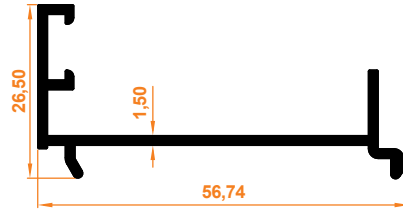

C60 Kanat Adaptörü Profili
C60 Wing Adapter Profile

7105

1,155 kg/m

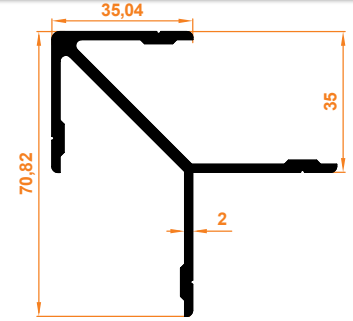

C60 Köşe Takozu
C60 Corner Wedge

7106

0,467 kg/m

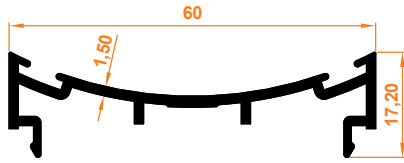

C60 Çarpma Kapı Adaptörü - Dişi
C60 Crash Door Adapter - Female

7107

0,367 kg/m

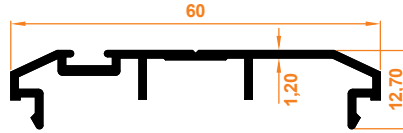

C60 Çarpma Kapı Adaptörü - Erkek
C60 Crash Door Adapter - Male

7108

0,241 kg/m

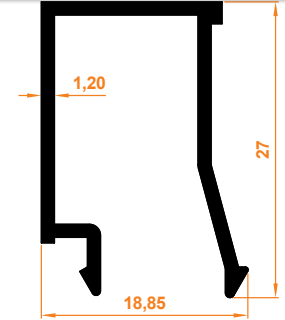

C60 Isıcam Çıta Profili
C60 Insulating Glass Stave Profile

7109

0,234 kg/m

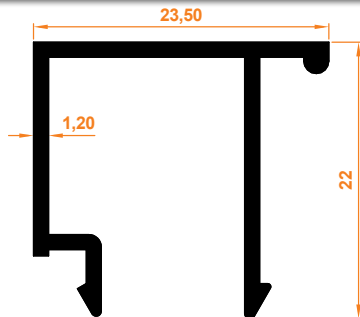

C60 Tek Cam Çıta Profili
C60 Single Glass Stave Profile

7000

0,473 kg/m

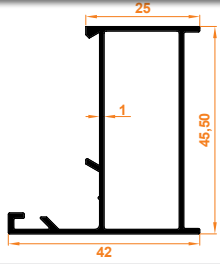

Aldoks (Dar) Kasa Profili
Aldoks (Tight) Frame Profile

7001

0,565 kg/m

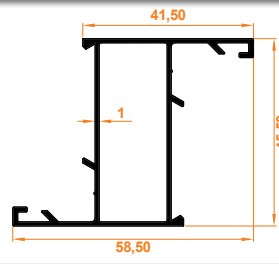

Aldoks (Dar) Kanat Profili
Aldoks (Tight) Wing Profile

7002

0,565 kg/m

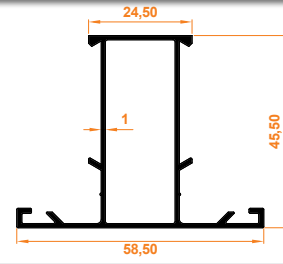

Aldoks (Dar) Orta Kayıt Profili
Aldoks (Tight) Mid Entry Profile

7003

0,891 kg/m

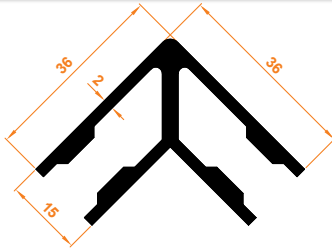

Aldoks (Dar) Köşe Takozu
Aldoks (Tight) Corner Wedge

7004

0,565 kg/m

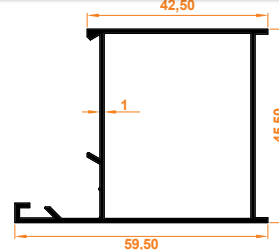

Aldoks (Orta) Kasa Profili
Aldoks (Mid) Frame Profile

7005

0,659 kg/m

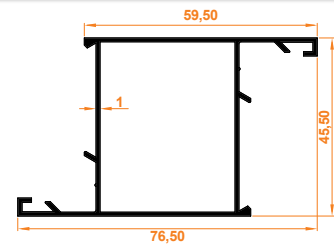

Aldoks (Orta) Kanat Profili
Aldoks (Mid) Wing Profile

7006

0,659 kg/m

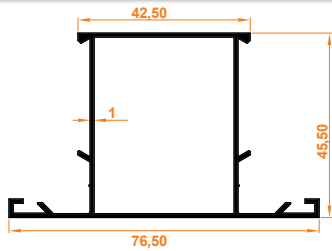

Aldoks (Orta) Kayıt Profili
Aldoks (Mid) Entry Profile

7007

1,136 kg/m

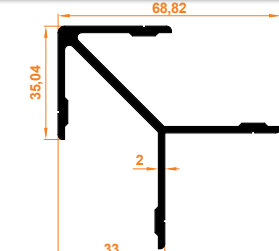

Aldoks (Orta) Köşe Takozu
Aldoks (Mid) Corner Wedge

7008

0,695 kg/m

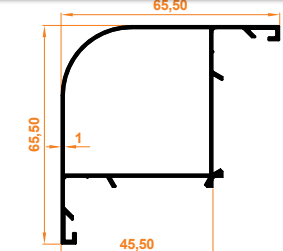

Aldoks Oval Köşe Dönüş Profili
Aldoks Oval Corner Profile

7009

0,719 kg/m

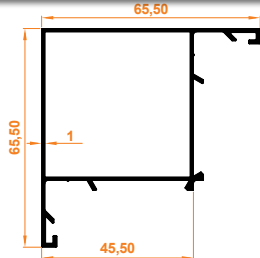

Aldoks Köşe Dönüş Profili
Aldoks Corner Profile

7010

1,028 kg/m

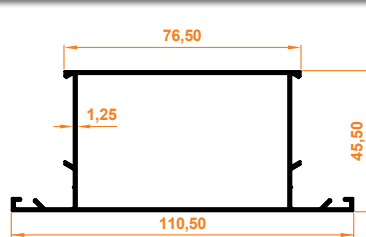

Aldoks (Geniş) Orta Kayıt Profili
Aldoks (Wide) Mid Entry Profile

7011

1,028 kg/m

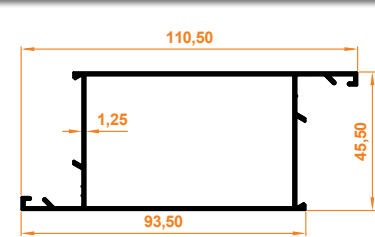

Aldoks (Geniş) Kanat Profili
Aldoks (Wide) Wing Profile

7012

1,149 kg/m

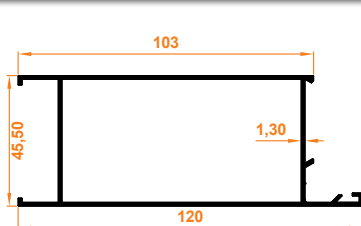

Aldoks Etek Profili
Aldoks Skirt Profile

7013

0,215 kg/m

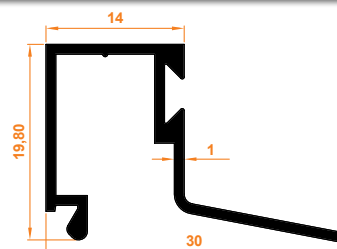

Aldoks Isıcam Çita
Aldoks Double Glazing Stave

7014

0,213 kg/m

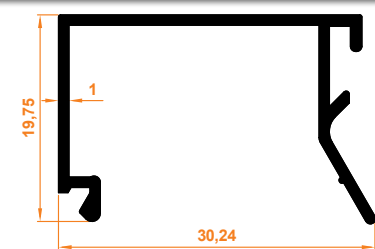

Aldoks Tek Cam Çita
Aldoks Single Glass Stave

700

0,185 kg/m

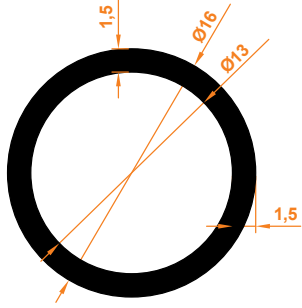

16x1,5 Boru
16x1,5 Pipe

701

0,538 kg/m

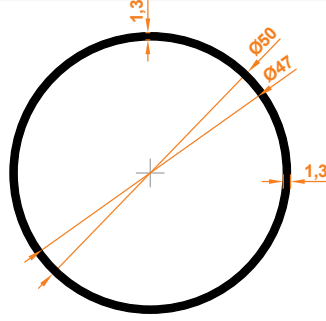

50x1,3 Boru
50x1,3 Pipe

702

0,509 kg/m

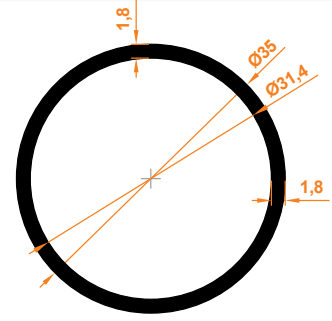

35x1,8 Boru
35x1,8 Pipe

703

0,182 kg/m

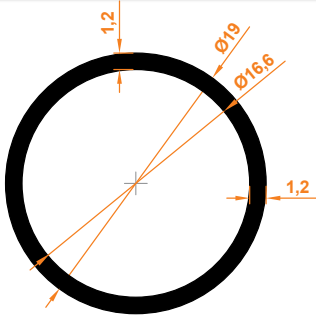

19x1,2 Boru
19x1,2 Pipe

704

0,162 kg/m

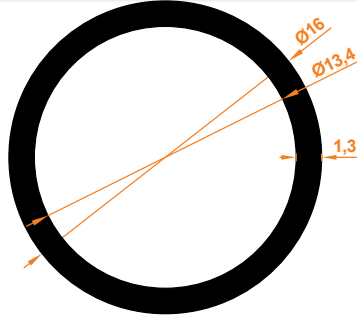

16x1,3 Boru
16x1,3 Pipe

900

0,685 kg/m

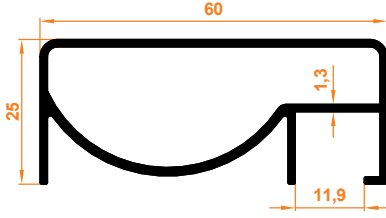

60x25 mm Üst Küpeşte Yandan Kanallı
60x25 mm Upper Handrail with Side Channel

901

0,230 kg/m

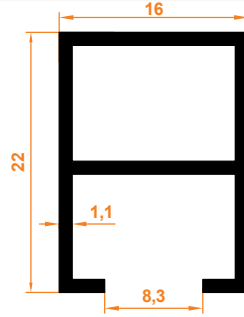

Cam Tutucu
Glass Holder

902

0,848 kg/m

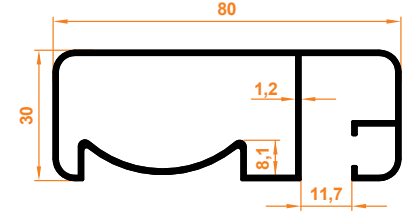

80x30 Yandan Kanallı
80x30 Side Channel

903

0,785 kg/m

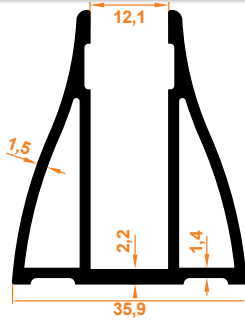

Cam Alt Baza
Glass Bottom Base

904

0,159 kg/m

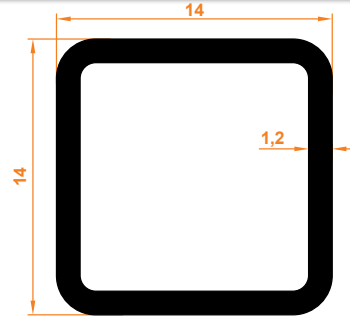

14x14 Emniyet Şeridi
14x14 Safety Strip

905

0,060 kg/m

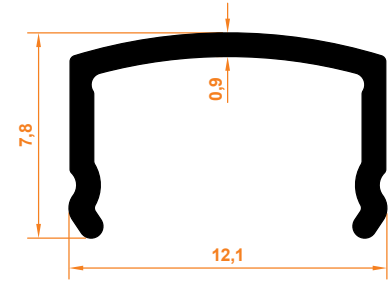

Boru Çıtası
Pipe Lath

906

0,650 kg/m

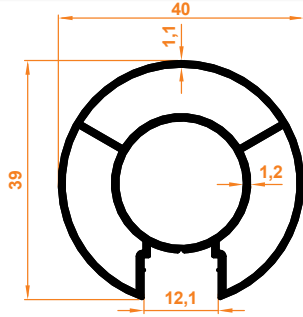

40x1,1 mm Tek Kanallı Çiftli Dikme
40x1,1 mm Single Channel Double Column

907

0,532 kg/m

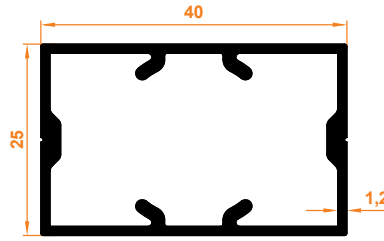

40x25 Dikme
40x25 Column

908

0,922 kg/m

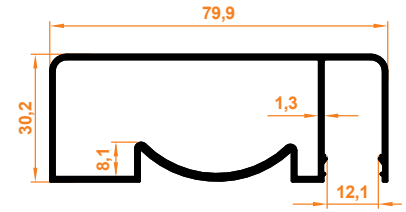

80x30 Yandan Kanallı
80x30 Side Channel

909

0,717 kg/m

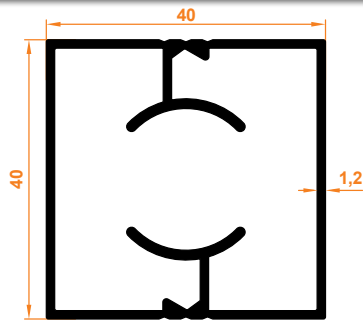

40x40 Kanalsız Dikme
40x40 Non Channel Column

910

0,631 kg/m

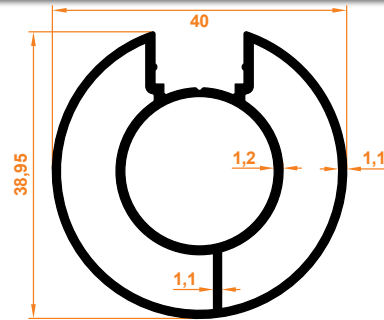

40x1,1 mm Tek Kanallı Tekli Dikme
40x1,1 mm Single Channel Single Column

911

0,840 kg/m

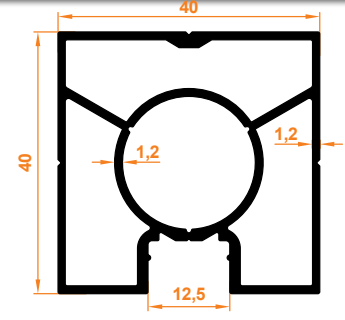

40x40 Tek Kanallı Dikme
40x40 Single Channel Column

912

0,641 kg/m

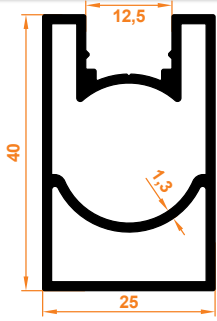

40x25 Tek Kanallı
40x25 Single Slot

913

0,064 kg/m

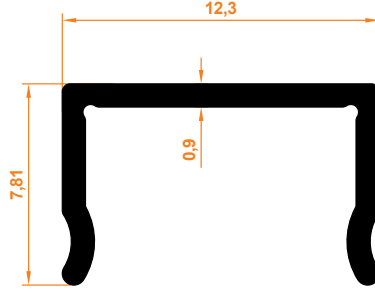

Kare Çita
Square Slat

914

0,082 kg/m

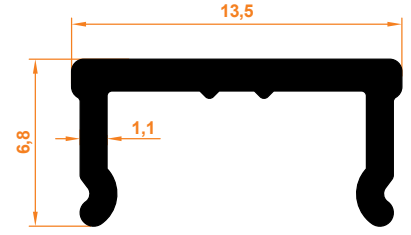

80x30 Yandan Kanallı Çıtası
80x30 Side Slot Rail

915

0,778 kg/m

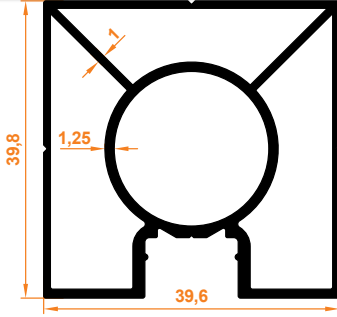

40x40 Tek Kanallı Dikme
40x40 Single Slot Column

916

0,627 kg/m

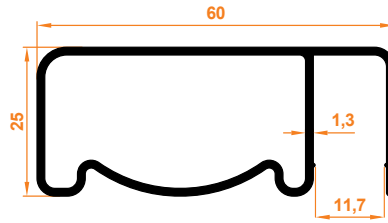

60x25 Yandan Kanallı
60x25 Side Slot

918

0,256 kg/m

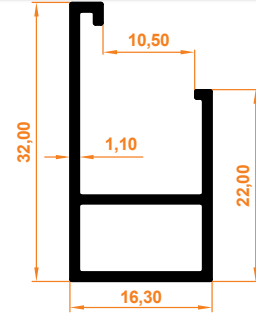

8-10 mm Cam Altı Profil
8-10 mm Glass Bottom

919

0,807 kg/m

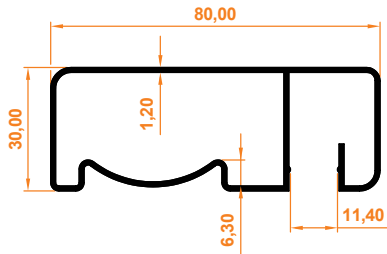

80x30 Yandan Kanallı
80x30 Side Slot

250

1,291 kg/m

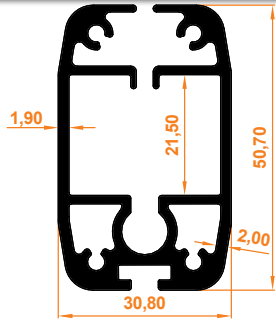

Kanat Profili
Wing Profile

251

0,572 kg/m

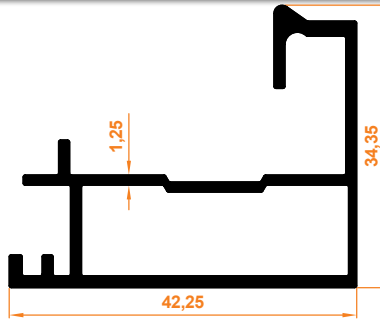

Yan Kasa Profili
Side Case Profile

252

0,313 kg/m

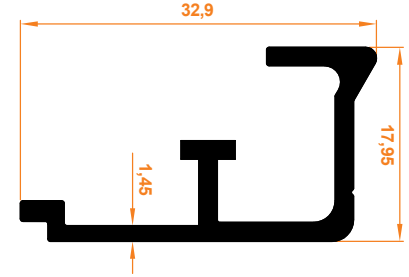

Yan Kasa Kapak Profili
Side Case Cover Profile

7150

1,776 kg/m

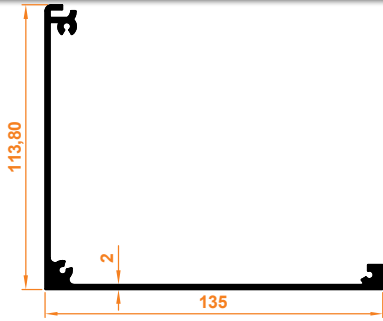

Üst Kasa Profili
Upper Case Profile

7151

1,475 kg/m

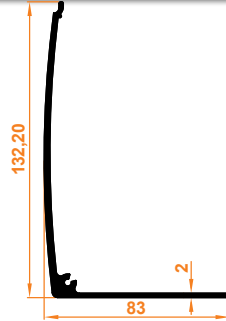

Üst Kasa Kapak Profili
Upper Case Cover Profile

ZP 13

2,110 kg/m

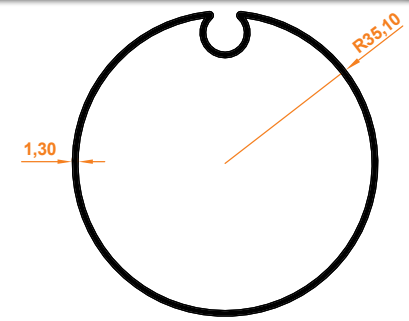

Sac Tambur Borusu
Sheet Drum Tube

ZP 15

0,800 kg/m



5x20 Lama Demir
5x20 Blade Iron

312

0,156 kg/m

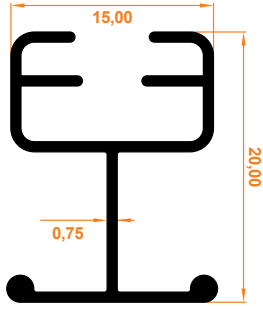

T Profil
T Profile

334

0,265 kg/m

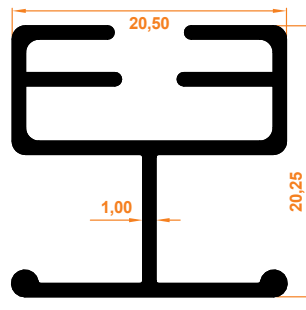

20'lik T Profil
20 T Profile

339

0,102 kg/m

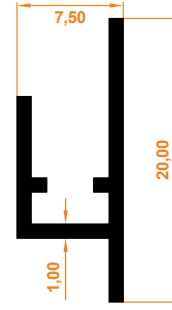

Yaylı Yapışkan Profil
Spring Adhesive Profile

332

0,094 kg/m

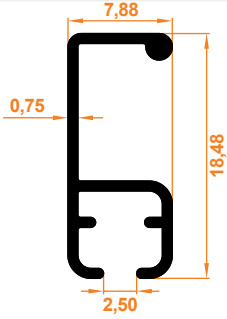

Small T Profil
Small T Profile

340

0,076 kg/m

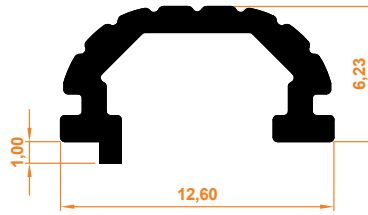

Yaylı Portray Profil
Spring Portray Profile

327

0,252 kg/m

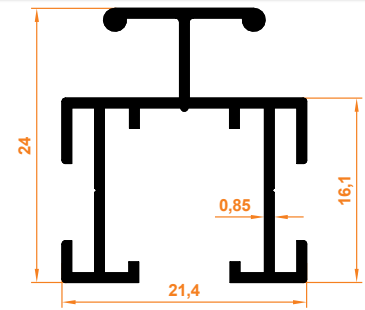

Çiftli Orta Profil
Double Middle Profile

200

0,136 kg/m

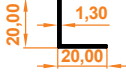

20x20 Köşebent
20x20 Angle Bracket

201

0,207 kg/m

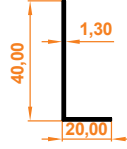

20x40 Köşebent
20x40 Angle Bracket

202

0,277 kg/m

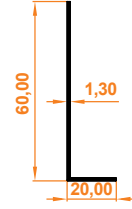

20x60 Köşebent
20x60 Angle Bracket

204

0,347 kg/m

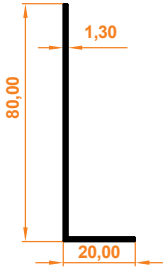

20x80 Köşebent
20x80 Angle Bracket

203

0,418 kg/m

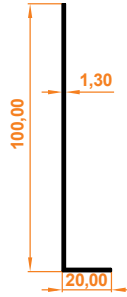

20x100 Köşebent
20x100 Angle Bracket

205

0,488 kg/m

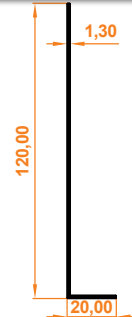

20x120 Köşebent
20x120 Angle Bracket

404

0,384 kg/m

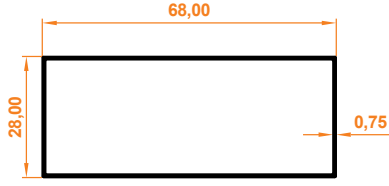

28x68 Kutu Profil
28x68 Box Profile

1044

0,960 kg/m

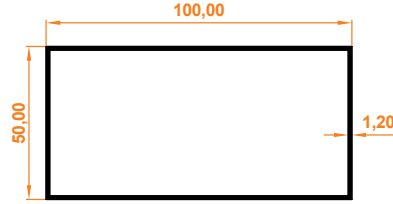

50x100 Kutu Profil
50x100 Box Profile

1102

0,531 kg/m

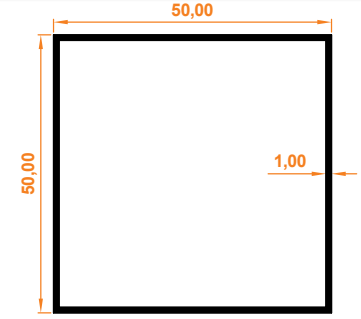

50x50 Kutu Profil
50x50 Box Profile

1400

0,426 kg/m

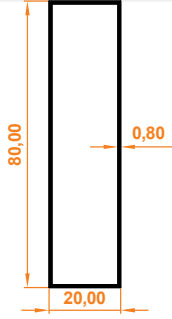

20x80 Kutu Profil
20x80 Box Profile

1402

0,917 kg/m

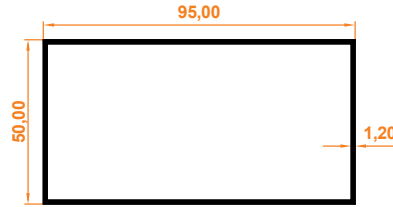

95x50 Kutu Profil
95x50 Box Profile

1403

0,505 kg/m

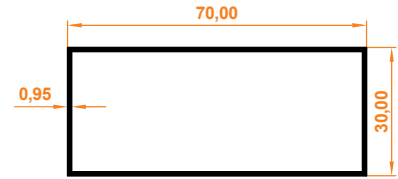

30x70 Kutu Profil
30x70 Box Profile

7

0,305 kg/m

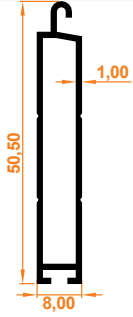

39x55 Alt Parça
39x55 Lower Part

8

0,502 kg/m

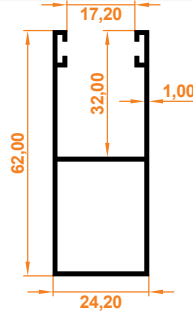

55'lik Yan Dikme
55 Side Column

9

0,439 kg/m

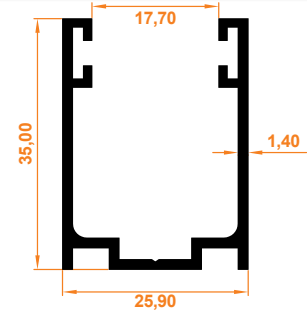

55'lik Kutusuz Dikme
55 Side Column Boxless

1130

0,372 kg/m

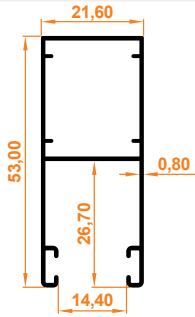

39'luk Yan Dikme
39 Side Column

ÖZEL ÜRETİM PROFİL GRUBU
Special Production Profile Group

510

1,174 kg/m

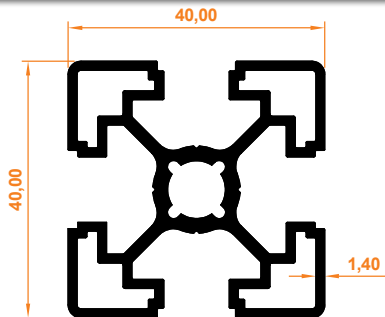

40x40 Sigma Profil
40x40 Sigma Profile

1003

0,053 kg/m

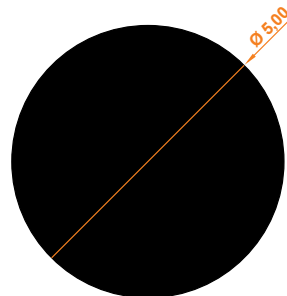

Q5 Dolu Mil
Q5 Solid Bar



GELECEĞİ ŞEKİLLENDİREN: PROCESS
İNOVASYONUN VE TASARIMIN BULUŞTUĞU DÜNYA

TASARIM VE İNOVASYONUN BULUŞMA NOKTASI

TASARIM VE İNOVASYONUN SINIRLARINI AŞAN BİR YOLCULUĞA ÇIKIN. PROCESS ALÜMİNYUM & PVC SİSTEMLERİ, ÇÖZÜMLERİN ÖNCÜSÜDÜR; SINIRLARI YENİDEN TANIMLAR VE İLHAM VEREN ÜRÜNLER SUNAR. BİZİMLE, HAYAL GÜCÜNÜN TITIZLIKLE BİR ARAYA GELDİĞİ BU YOLCULUĞA KATILIN VE BİRLİKTE DAHA PARLAK BİR GELECEK OLUŞTURALIM.

CRAFTING THE FUTURE: PROCESS'S INNOVATIVE WORLD

WHERE DESIGN AND INNOVATION CONVERGE

EMBARK ON A JOURNEY THAT TRANSCENDS THE BOUNDARIES OF DESIGN AND INNOVATION. PROCESS ALUMINIUM & PVC SYSTEMS LEADS THE WAY IN SOLUTIONS, REDEFINING LIMITS, AND OFFERING INSPIRATIONAL PRODUCTS. JOIN US ON THIS JOURNEY WHERE IMAGINATION MEETS PRECISION, AND TOGETHER, LET'S BUILD A BRIGHTER FUTURE.

Process Alüminyum Plastik San. Tic. Ltd. Şti.

MERKEZ

Aşağıpınarbaşı OSB Mah. 524 Nolu Sk. No: 3/1 42250,
Selçuklu-Konya/TÜRKİYE

T : +90 332 248 00 92

F : +90 332 248 00 93

M : info@process.com.tr

MARMARA BÖLGE MÜDÜRLÜĞÜ

Cihangir Mh. Talatpaşa Cad. No:67
Avcılar/İSTANBUL - TÜRKİYE

T : +90 212 407 17 42

F : +90 212 407 15 42

M : marmara@process.com.tr

|| www.process.com.tr

|| www.processplise.com.tr

|| www.panjurmen.com.tr

|| www.demarco.com.tr

|| www.prosin.com.tr

