



|| [www.process.com.tr](http://www.process.com.tr) || [www.demarco.com.tr](http://www.demarco.com.tr) || [www.processplise.com.tr](http://www.processplise.com.tr) || [www.prosin.com.tr](http://www.prosin.com.tr) || [www.panjumen.com.tr](http://www.panjumen.com.tr)

v.08 **2025**  
**Ürün Kataloğu**  
Product Catalog



Firmamız, **Process Alüminyum ve PVC Sistemleri** ünvanıyla 2002 yılında Konya'da kurulmuştur.

Firmamızın uzmanlaştığı üretim alanları; sineklik sistemleri, cam balkon sistemleri, plise perde sistemleri, zip perde, cam tavan ve tavan kapatma sistemleridir. Tüm bu sistemleri oluşturan plastik aksesuarlar, alüminyum profiller ve polyester tül ile plise perde kumaşları, kendi tesislerimizde üretilmektedir. Tesisimiz 35.000 m<sup>2</sup> kapalı, 15.000 m<sup>2</sup> açık alanı olmak üzere toplam 50.000 m<sup>2</sup>'dir. Plastik enjeksiyon üretim bölümünde 15 adet enjeksiyon makinesi ile 24 saat çalışma esasıyla günlük ortalama 300.000 adet parça üretebilmektedir. Alüminyum ekstrüzyon bölümümüzde aylık ortalama 850 ton alüminyum profil üretilmektedir. Üretilen alüminyum profiller yine kendi tesisimizde yüzey işlemlerinden (eloksal - elektrostatik boya) geçmekte ve son olarak paketlenip sevk edilmektedir. Türkiye içerisinde 900 civarında atölyede ürünlerimiz işlenmekte ve son tüketiciye ulaştırılmaktadır. Türkiye dışında Balkan ülkelerinin tamamı, Avrupa Kıtasında; Almanya, Hollanda, Danimarka, Kuzey Afrikada; Tunus ve Cezayir, Orta Doğu'da; Irak ve İsrail'in yanı sıra Ermenistan, Azerbaycan, Arap Emirlikleri, Dubai, Katar, Ürdün gibi ülkelerde bayilikler oluşturulmuştur. Şu anda toplam ürünlerimizin %35'ini ihraç etmekteyiz.

Perde sektöründe son zamanların trend ürünü olan plise perde sistemlerini kendi Ar-Ge merkezimizde geliştirerek sektörün hizmetine sunmuş bulunmaktadır. Mekanik perde atölyeleri tarafından bugüne kadar Türkiye genelinde 150 adet bayilik oluşturulmuş ve bu bayilikler artarak çoğalmaktadır. Plise perdeyi oluşturan tüm parçaları; plastik aksesuarlar, alüminyum çita ve profiller, katlanmış pileli kumaşlar ürünlerimizi kendi tesislerimizde üretilip bayilerimize ulaştırmaktayız. 167 farklı desen ve renkte kumaş çeşidi olan firmamız çok güçlü stok altyapısı ile sektörün ihtiyacı olan hizmeti ve hızı sunmaktadır.

Our company, operating under the name of **Process Aluminum and PVC Systems**, was founded in 2002 in Konya.

Process specializes in the production of the following areas: insect screen systems, glass balcony systems, pleated blind systems, zip blinds, glass roofs, and ceiling closure systems. All the plastic accessories, aluminum profiles, polyester mesh, and pleated blind fabrics that make up these systems are manufactured in our own facilities. Our facility covers a total area of 50,000 m<sup>2</sup>, with 35,000 m<sup>2</sup> indoors and 15,000 m<sup>2</sup> outdoors. In the plastic injection production department, we can produce an average of 300,000 pieces per day with 15 injection machines operating 24 hours a day. In our aluminum extrusion department, an average of 850 tons of aluminum profiles are produced monthly. The aluminum profiles produced undergo surface treatments (anodizing - electrostatic paint) in our own facilities before being packaged and shipped. Within Turkey, our products are processed in approximately 900 workshops and delivered to end consumers. Outside of Turkey, we have established dealerships in all Balkan countries, across the European continent including Germany, Netherlands, France, and Denmark, in North Africa including Tunisia and Algeria, in the Middle East including Iraq and Israel, as well as in countries such as Georgia, Armenia, Azerbaijan, the United Arab Emirates, Dubai, Qatar, Jordan, and more. Currently, we export 35% of our total products.

In the curtain sector, our company has developed and introduced pleated blind systems, the trend product of recent years, to the market through our own R&D center. Nowadays, we have established 150 dealerships across Turkey in the mechanical curtain workshops, and the number of dealers is increasing. We manufacture all the components that make up pleated blinds, including plastic accessories, aluminum bars, profiles, and folded pleated fabrics, in our own facilities and deliver them to our dealers. With 167 different patterns and colors of fabric, our company provides the service and speed that the market needs with its strong stock level.





GELECEK YAPI MİMARİ  
**Tüm Yaşam Alanlarında**

In all living areas

Future Structure Architecture



**KALİTE**  
QUALITY

**EKONOMİK**  
ECONOMIC

**GARANTİ**  
WARRANTY



ÜRÜN KODU Product Code	ÖZELLİKLERİ Properties	ÖLÇÜLERİ Dimensions	RENKLER Colors	KOLI İÇİ ADET Quantity Per Box
PJM - 01	Panjurmen Menfez / Vent	27 x 32	□ ■ ■	20
PJM - 02	Panjurmen Menfez / Vent	25 x 45	□ ■ ■	20
PJM - 19	Panjurmen Menfez / Vent	30 x 30	□ ■ ■	20
PJM - 16	Panjurmen Menfez / Vent	30 x 40	□	20
PJM - 03	Panjurmen Menfez / Vent	35 x 35	□ ■ ■	20
PJM - 04	Panjurmen Menfez / Vent	35 x 45	□ ■ ■	20
PJM - 05	Panjurmen Menfez / Vent	35 x 55	□ ■ ■	20
PJM - 06	Panjurmen Menfez / Vent	40 x 40	□ ■ ■	20
PJM - 15	Panjurmen Menfez / Vent	40 x 50	□	20
PJM - 07	Panjurmen Menfez / Vent	45 x 45	□ ■ ■	20
PJM - 08	Panjurmen Menfez / Vent	45 x 55	□ ■ ■	20
PJM - 09	Panjurmen Menfez / Vent	45 x 65	□ ■ ■	20
PJM - 10	Panjurmen Menfez / Vent	65 x 45	□	20
PJM - 11	Panjurmen Menfez / Vent	50 x 50	□ ■ ■	20
PJM - 17	Panjurmen Menfez / Vent	50 x 60	□	20
PJM - 12	Panjurmen Menfez / Vent	55 x 55	□ ■ ■	20
PJM - 13	Panjurmen Menfez / Vent	55 x 65	□	20
PJM - 18	Panjurmen Menfez / Vent	60 x 60	□ ■ ■	20
PJM - 14	Panjurmen Menfez / Vent	65 x 65	□ ■ ■	15

CMS 01

Parlak Eloksal  
Gloss Anodized



Boru Tipi Çamaşır Askısı  
Pipe Type Clotheshorse

Koli İçi Adet  
Quantity Per Box

20

CMS 02

Parlak Eloksal  
Gloss Anodized



Duvar Tipi Çamaşır Askısı  
Wall Type Clotheshorse

Koli İçi Adet  
Quantity Per Box

15

CMS 03

Parlak Eloksal  
Gloss Anodized



Ayarlı Kare Çamaşır Askısı (25x60cm ve 30x80 cm)  
Adjustable Square Clotheshorse (25x60cm and 30x80cm)

Koli İçi Adet  
Quantity Per Box

20

CMS 04

Parlak Eloksal  
Gloss Anodized



25x60cm Çamaşır Askısı  
25x60cm Clotheshorse

Koli İçi Adet  
Quantity Per Box

20

CMS 05

Parlak Eloksal  
Gloss Anodized



30x80cm Çamaşır Askısı  
30x80cm Clotheshorse

Koli İçi Adet  
Quantity Per Box

20

CMS 06

Parlak Eloksal  
Gloss Anodized



Lüks Çamaşır Askısı  
Luxurious Clotheshorse

Koli İçi Adet  
Quantity Per Box

20

CMS 07

Parlak Eloksal  
Gloss Anodized



40x40 Kare Çamaşır Askısı  
40x40 Square Clotheshorse

Koli İçi Adet  
Quantity Per Box

20

Alüminyum Renk Seçeneği

Aluminum Color Options

PB

Parlak Eloksal  
Gloss Anodized

P0

Parlak Bronz  
Gloss Bronze

7016

Antrasit Gri  
Anthracite Gray



ÜRÜN ADI Product Name	AÇIKLAMA Explanation
<b>Doğalgaz Takım (Isıcam)</b> Natural Gas Set (Double-Glass)	3 m
<b>Doğalgaz Sağ-Sol Başlık</b> Natural Gas Right-Left Header (CAP)	<b>Adet</b> Pcs
<b>Doğalgaz Takım (Tekcam 8mm)</b> Natural Gas Set (Single-Glass 8mm)	3 m
<b>Doğalgaz Takım (Tekcam 10mm)</b> Natural Gas Set (Single-Glass 10mm)	<b>Adet</b> Pcs
<b>Doğalgaz Sağ-Sol Başlık</b> Natural Gas Right-Left Header (CAP)	3 m
<b>Oda Havalandırma</b> Room Ventilation	3 m
<b>Sağ-Sol Başlık</b> Right Left Header (CAP)	<b>Adet</b> Pcs

**ONAYLI ÜRÜN**  
APPROVED PRODUCT



Ürünlerimiz Patentli Olup;  
İGDAŞ Onaylıdır.

Our products have patent  
and approved by İGDAŞ.

## AYARLI CAM TAKOZU

Adjustable Glass Wedges

ÜRÜN ADI Product Name	ÜRÜN KODU Product Code	KOLİ İÇİ ADET (m <sup>2</sup> ) Quantity Per Box (m <sup>2</sup> )
<b>18 mm Ayarlı Cam Takozu</b> / 18 mm Adjustable Glass Wedge	ACT 1	500
<b>24 mm Ayarlı Cam Takozu</b> / 24 mm Adjustable Glass Wedge	ACT 2	400
<b>28 mm Ayarlı Cam Takozu</b> / 28 mm Adjustable Glass Wedge	ACT 3	400
<b>32 mm Ayarlı Cam Takozu</b> / 32 mm Adjustable Glass Wedge	ACT 4	400
<b>Ayarlı Cam Takozu Pensesi</b> / Adjustable Glass Wedge Holder	ACT 5	1



### ÖZELLİKLER

PROPERTIES

Kanat sarkmalarını ortadan kaldırır.  
It eliminates wing sagging.

PVC, ahşap ve alüminyum doğramalarda kullanılabilir.  
It can be used in PVC, wood and aluminum joinery.

Ayar pensesi sayesinde kanadınızın kolaylıkla teraziye alınmasını sağlar.  
With the adjustment pliers, your wing can be easily leveled.

Ekstra takoz seçeneğiyle standartların üzerinde kaldırma kapasitesine sahiptir.  
It has a lifting capacity above standards with extra chock option.



⊕ İşaretili ürünler özel üretimdir.  
⊕ Marked products are special production.

ÜRÜN KODU Product Code	ÖLÇÜLERİ Dimensions	KOLİ İÇİ RULO Quantity Per Box (roll)	RULO/METRE Roll/Meter	KOLİ İÇİ ADET (m) Quantity Per Box (m)
FİTİL 7 ⊕	45-800	4	275	1.100
FİTİL 01 ⊕	48-450	4	550	2.200
FİTİL 02	48-500	4	550	2.200
FİTİL 03	48-550	4	500	2.000
FİTİL 60	48-600	4	450	1.800
FİTİL 04	48-650	4	450	1.800
FİTİL 47 ⊕	48-700	4	400	1.600
FİTİL 05	48-800	4	275	1.100
FİTİL 71	48-900	4	250	1.000
FİTİL 06	48-1.000	4	250	1.000
FİTİL 07	48-1.200	4	200	800
FİTİL 08 ⊕	48-1.500	4	150	600
FİTİL 09	51-500	4	375	1.500
FİTİL 10	51-550	4	375	1.500
FİTİL 11	51-650	4	350	1.400
FİTİL 12	51-800	4	325	1.300
FİTİL 59	51-1.000	4	250	1.000
FİTİL 50 ⊕	51-1.200	4	200	800
FİTİL 13	55-550	4	350	1.400
FİTİL 69 ⊕	55-600	4	350	1.400
FİTİL 77 ⊕	55-650	4	350	1.400
FİTİL 14	55-700	4	350	1.400
FİTİL 72	55-800	4	325	1.300
FİTİL 75 ⊕	55-1.000	4	250	1.000
FİTİL 15	60-575	4	350	1.400
FİTİL 17	67-450	4	375	1.500
FİTİL 18	67-500	4	375	1.500
FİTİL 19	67-550	4	375	1.500
FİTİL 20	67-600	4	350	1.400
FİTİL 21	67-650	4	350	1.400
FİTİL 22	67-700	4	300	1.200
FİTİL 23	67-800	4	250	1.000
FİTİL 24	67-900	4	225	900
FİTİL 25	67-1.000	4	200	800
FİTİL 58 ⊕	67-1.100	4	175	700
FİTİL 26	67-1.200	4	175	700
FİTİL 27	67-1.500	4	125	500
FİTİL 57 ⊕	67-1.800	4	125	500
FİTİL 64 ⊕	67-2.000	4	100	400
FİTİL 61 ⊕	69-550	4	375	1.500
FİTİL 28	69-700	4	250	1.000
FİTİL 73 ⊕	69-1.000	4	200	800
FİTİL 74 ⊕	69-1.200	4	175	700
FİTİL 29	72-800	4	200	800
FİTİL 56	127-700	4	175	700

⊕ İşaretili ürünler özel üretimdir.  
 ⊕ Marked products are special production.

ÜRÜN KODU Product Code	ÖLÇÜLERİ Dimensions	KOLI İÇİ RULO Quantity Per Box (roll)	RULO/METRE Roll/Meter	KOLI İÇİ ADET (m) Quantity Per Box (m)
FİTİL 78 ⊕	51-550 Finli (finned)	4	350	1.400
FİTİL 31	51-650 Finli (finned)	4	325	1.300
FİTİL 32	51-800 Finli (finned)	4	300	1.200
FİTİL 51 ⊕	51-1.000 Finli (finned)	4	225	900
FİTİL 77 ⊕	55-650 Finli (finned)	4	325	1.300
FİTİL 33	55-700 Finli (finned)	4	325	1.300
FİTİL 34	55-800 Finli (finned)	4	300	1.200
FİTİL 35	60-575 Finli (finned)	4	325	1.300
FİTİL 84 ⊕	67-600 Finli (finned)	4	325	1.300
FİTİL 55 ⊕	67-650 Finli (finned)	4	325	1.300
FİTİL 37	67-700 Finli (finned)	4	275	1.100
FİTİL 39	67-1.000 Finli (finned)	4	175	700
FİTİL 46	67-1.200 Finli (finned)	4	150	600
FİTİL 40	69-700 Finli (finned)	4	225	900
FİTİL 41	69-800 Finli (finned)	4	225	900
FİTİL 42	69-1.000 Finli (finned)	4	175	700
FİTİL 43	72-800 Finli (finned)	4	175	700
FİTİL 44	127-700 Finli (finned)	4	125	500
FİTİL 100	51-550 Finli Tela (finned tela)	4	350	1.400
FİTİL 101	51-650 Finli Tela (finned tela)	4	325	1.300
FİTİL 102	51-800 Finli Tela (finned tela)	4	300	1.200
FİTİL 103	55-650 Finli Tela (finned tela)	4	325	1.300
FİTİL 104	55-700 Finli Tela (finned tela)	4	325	1.300
FİTİL 105	55-800 Finli Tela (finned tela)	4	300	1.200
FİTİL 106	60-575 Finli Tela (finned tela)	4	325	1.300
FİTİL 107	67-700 Finli Tela (finned tela)	4	275	1.100
FİTİL 108	67-1.000 Finli Tela (finned tela)	4	175	700
FİTİL 109	67-1.200 Finli Tela (finned tela)	4	150	600
FİTİL 110	69-700 Finli Tela (finned tela)	4	225	900
FİTİL 111	69-800 Finli Tela (finned tela)	4	225	900
FİTİL 112	69-1.000 Finli Tela (finned tela)	4	175	700
FİTİL 113	72-800 Finli Tela (finned tela)	4	175	700
FİTİL 114	127-700 Finli Tela (finned tela)	4	125	500
FİTİL 200	67-450 Yapışkan (adhesive)	4	350	1.400
FİTİL 201	67-500 Yapışkan (adhesive)	4	350	1.400
FİTİL 202	67-550 Yapışkan (adhesive)	4	350	1.400
FİTİL 203	67-600 Yapışkan (adhesive)	4	325	1.300
FİTİL 204	67-650 Yapışkan (adhesive)	4	325	1.300
FİTİL 205	67-700 Yapışkan (adhesive)	4	275	1.100
FİTİL 206	67-800 Yapışkan (adhesive)	4	225	900
FİTİL 207	67-900 Yapışkan (adhesive)	4	200	800
FİTİL 208	67-1.000 Yapışkan (adhesive)	4	175	700
FİTİL 209	67-1.100 Yapışkan (adhesive)	4	150	600
FİTİL 210	67-1.200 Yapışkan (adhesive)	4	150	600
FİTİL 211	67-1.500 Yapışkan (adhesive)	4	125	500
FİTİL 212	67-1.800 Yapışkan (adhesive)	4	125	500
FİTİL 213	67-2.000 Yapışkan (adhesive)	4	100	400



ÜRÜN ADI Product Name	ÜRÜN KODU Product Code	RULO m <sup>2</sup> Roll m <sup>2</sup>	KOLİ İÇİ ADET (m <sup>2</sup> ) Amount within Parcel (m <sup>2</sup> )
60cmx30m Sineklik Tülü / 60cmx30m Flynet Tulle	60 S	18 m <sup>2</sup>	6
80cmx30m Sineklik Tülü / 80cmx30m Flynet Tulle	80 S	24 m <sup>2</sup>	6
100cmx30m Sineklik Tülü / 100cmx30m Flynet Tulle	100 S	30 m <sup>2</sup>	6
120cmx30m Sineklik Tülü / 120cmx30m Flynet Tulle	120 S	36 m <sup>2</sup>	6
140cmx30m Sineklik Tülü / 140cmx30m Flynet Tulle	140 S	42 m <sup>2</sup>	6
160cmx30m Sineklik Tülü / 160cmx30m Flynet Tulle	160 S	48 m <sup>2</sup>	6
180cmx30m Sineklik Tülü / 180cmx30m Flynet Tulle	180 S	54 m <sup>2</sup>	6
200cmx30m Sineklik Tülü / 200cmx30m Flynet Tulle	200 S	60 m <sup>2</sup>	6
220cmx30m Sineklik Tülü / 220cmx30m Flynet Tulle	220 S	66 m <sup>2</sup>	6
240cmx30m Sineklik Tülü / 240cmx30m Flynet Tulle	240 S	72 m <sup>2</sup>	6
Pet Tül 100 / Pet Tulle 100	100 PET	10 m <sup>2</sup>	6
Pet Tül 120 / Pet Tulle 120	120 PET	12 m <sup>2</sup>	6
Pet Tül 140 / Pet Tulle 140	140 PET	14 m <sup>2</sup>	6
Pet Tül 160 / Pet Tulle 160	160 PET	16 m <sup>2</sup>	6
Pet Tül 220 / Pet Tulle 220	220 PET	22 m <sup>2</sup>	6

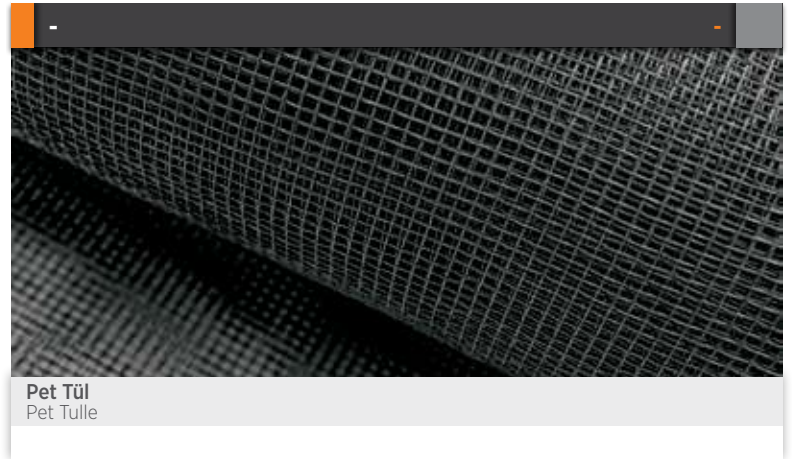

**GOLD SERİ PLİSE SİNEKLİK / GOLD SERIES PLEATED FLY SCREEN**

**İçten Gergi**

Internal Tensioner

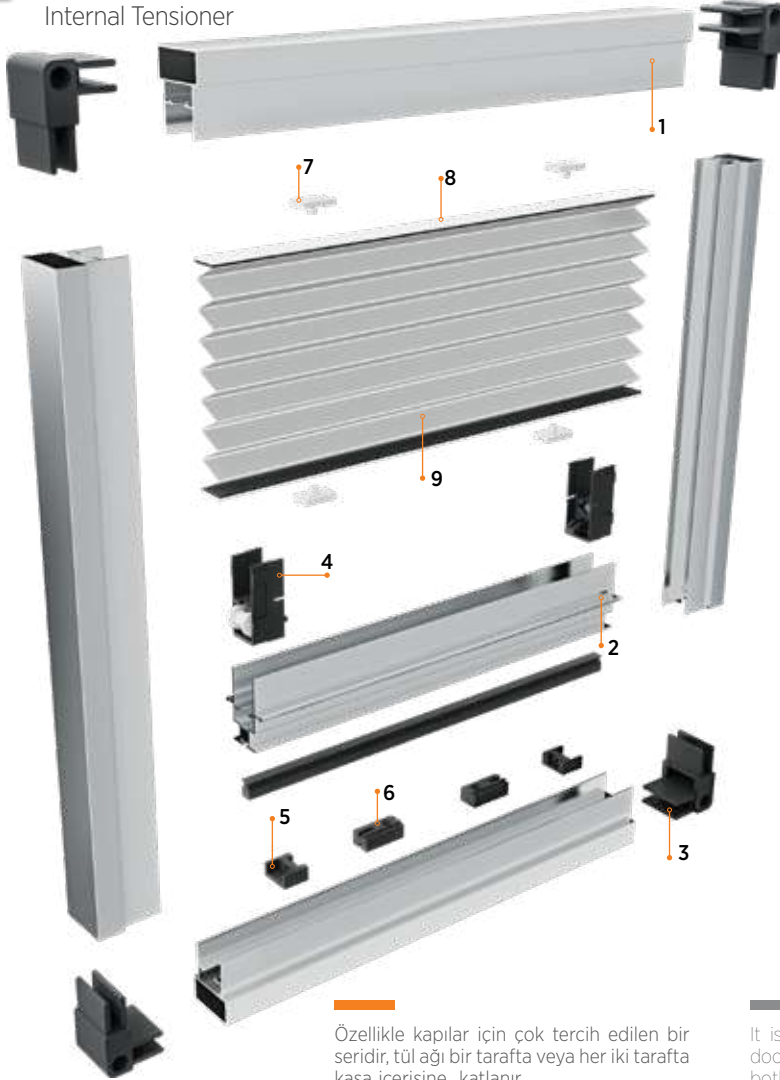

Özellikle kapılar için çok tercih edilen bir seridir, tül ağı bir tarafta veya her iki tarafta kasa içerisine katlanır.

Pileli kaset, alüminyum kasa profili ile kapı veya pencere pervazına, köşe takozlarında yer alan montaj deliklerinden vida yardımıyla doğrudan ve kolayca sabitlenir. 19 mm tül ve banta uygundur.

It is a very preferred series especially for doors, tulle net folds on one side or folds on both sides into the case.

The Gold series fly screen system is directly and easily fixed to the door or window sill with the help of screws through the mounting holes in the corner wedges. Suitable for 19 mm tulle and tape.



**İçten Gergi Set İçeriği / Internal Tensioner Set Contents**

No	ÜRÜN KODU Product Code	ÜRÜN ADI Product Name
1	304	Gold Kasa Gold Case
2	305	Gold Kanat Gold Wing
3	PLS 70	Köşe Takoza Corner Wedge
4	PLS 72	Rulman Takımı Bearing Set
5	PLS 73	İp Kontrol Plastiği Rope Control Plastic
6	PLS 74	İp Gergi Takoza Rope Tensioner Chock
7	PLS 150	Delikli Klips Hole Clip
8	PLS 51	PVC Bantlı Şerit PVC Taped Stripe
9	-	Plise Tül Pleated Tulle



**304**  
Gold Kasa Profil  
Gold Case Profile  
Paket İçi Adet  
Quantity Per Package 10 Gramajı  
Weight 0,318 kg/m



**305**  
Gold Kanat Profil  
Gold Wing profile  
Paket İçi Adet  
Quantity Per Package 10 Gramajı  
Weight 0,330 kg/m



**AKS 09  
AKS 10** Beyaz / White  
Siyah / Black  
Gold Seri İçten Gergi Aksesuar Seti  
Gold Serie Internal Tensioner Accessory Set  
Koli İçi Adet  
Quantity Per Box 100 Set Renk  
Color

**Alüminyum Renk Seçeneği**

Aluminum Color Options

**9016**

Beyaz  
White

**Eloksal Boyalı**

Anodized Painted

**Bronz Boyalı**

Bronze Painted

**8003**

Altın Meşe  
Golden Oak

**8016**

Maun  
Mahogany

**7016**

Antrasit Gri  
Anthracite Gray

## STAR SERİ PLİSE SİNEKLİK / STAR SERIES PLEATED FLY SCREEN

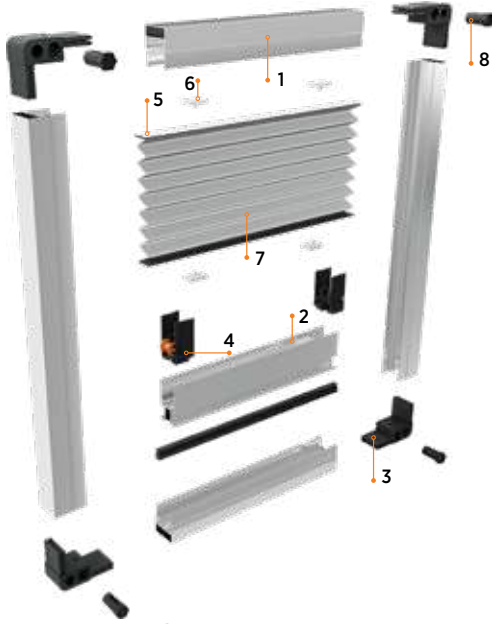

**Köşeden Gergi Set İçeriği / Corner Tensioner Set Contents**

No	ÜRÜN KODU Product Code	ÜRÜN ADI Product Name
1	356	Star Kasa Star Case
2	307	Star Kanat Star Wing
3	PLS 100	Köşe Takoğu Corner Wedge
4	PLS 102	Rulman Takımı Bearing Set
5	PLS 51	PVC Bantlı Şerit PVC Taped Stripe
6	PLS 450	Delikli Klips Hole Clip
7	-	Plise Tül Pleated Tulle
8	PLS 104	Köşe Takoğu Pimi Corner Wedge Pin

**AKS 05** Beyaz / White  
**AKS 06** Siyah / Black



**Star Seri Köşeden Gergi Aksesuar Seti**  
Star Series Corner Tensioner Accessory Set

Koli İçi Adet Quantity Per Box	100 Set	Renk Color	<input type="checkbox"/>	<input type="checkbox"/>
-----------------------------------	---------	---------------	--------------------------	--------------------------

**307**



**Star Kanat Profil**  
Star Wing Profile

Paket İçi Adet Quantity Per Package	10	Gramajı Weight	0,304 kg/m
----------------------------------------	----	-------------------	------------

İki model vardır: Köşeden Gergi ve İçten Gergi. Her model için farklı aksesuarlar mevcuttur.

Kasa genişliğinin Gold serisinden daha dar olması nedeniyle bazı alanlarda montaj kolaylığı sağlar. 19 mm tül ve banta uygundur.

There are two models: Corner Tensioner and Internal Tensioner. Different accessories are available for each model.

Due to the narrower width of the case than the Gold series, in some areas provides ease of assembly. Suitable for 19 mm tulle and tape.

### İçten Gergi

Internal Tensioner

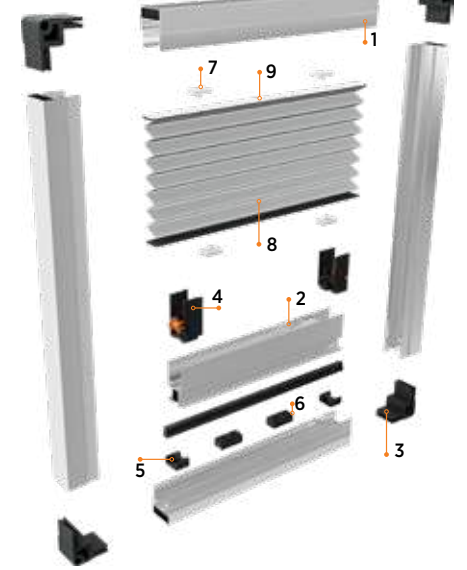

**İçten Gergi Set İçeriği / Internal Tensioner Set Contents**

No	ÜRÜN KODU Product Code	ÜRÜN ADI Product Name
1	356	Star Kasa Star Case
2	307	Star Kanat Star Wing
3	PLS 402	Köşe Takoğu Corner Wedge
4	PLS 102	Rulman Takımı Bearing Set
5	PLS 430	İp Kontrol Rope Control
6	PLS 431	İp Gergi Takoğu Rope Tensioner Chock
7	PLS 450	Delikli Klips Hole Clip
8	-	Plise Tül Pleated Tulle
9	PLS 51	PVC Bantlı Şerit PVC Taped Stripe

**AKS 07** Beyaz / White  
**AKS 08** Siyah / Black



**Star Seri İçten Gergi Aksesuar Seti**  
Star Serie Internal Tensioner Accessory Set

Koli İçi Adet Quantity Per Box	100 Set	Renk Color	<input type="checkbox"/>	<input type="checkbox"/>
-----------------------------------	---------	---------------	--------------------------	--------------------------

### Alüminyum Renk Seçeneği

Aluminum Color Options

<b>9016</b> Beyaz White	<b>Eloksal Boyalı</b> Anodized Painted	<b>Bronz Boyalı</b> Bronze Painted
<b>8003</b> Altın Meşe Golden Oak	<b>8016</b> Maun Mahogany	<b>7016</b> Antrasit Gri Anthracite Gray

**SLİM SERİ PLİSE SİNEKLİK / SLİM SERIES PLEATED FLY SCREEN**

**Köşeden Gergi**

Corner Tensioner

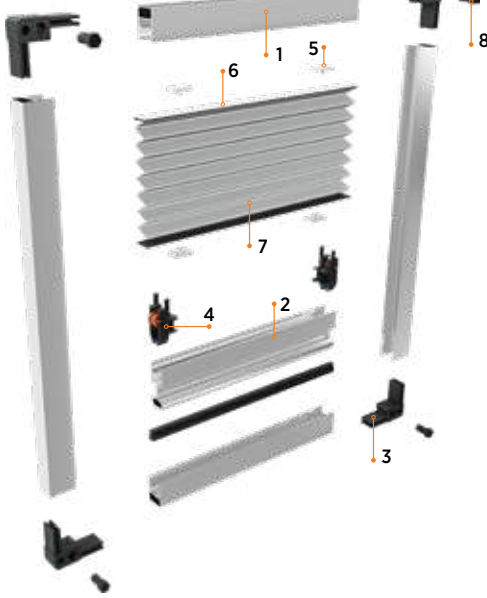

**Köşeden Gergi Set İçeriği / Corner Tensioner Set Contents**

No	ÜRÜN KODU Product Code	ÜRÜN ADI Product Name
1	300	<b>Slim Kasa</b> Slim Case
2	358	<b>Slim Kanat</b> Slim Wing
3	PLS 110	<b>Köşe Takozu</b> Corner Wedge
4	PLS 112	<b>Rulman Takımı</b> Bearing Set
5	PLS 550	<b>Delikli Klips</b> Hole Clip
6	PLS 50	<b>PVC Bantlı Şerit</b> PVC Taped Stripe
7	-	<b>Plise Tül</b> Pleated Tulle
8	PLS 115	<b>Köşe Takozu Pimi</b> Corner Wedge Pin

**AKS 01**  
**AKS 02**

**Beyaz / White**  
**Siyah / Black**



**Slim Seri Köşeden Gergi Aksesuar Seti**  
Slim Series Corner Tensioner Accessory Set

Koli İçi Adet Quantity Per Box	100 Set	Renk Color	<input type="checkbox"/>	<input type="checkbox"/>
-----------------------------------	---------	---------------	--------------------------	--------------------------

**300**



**Slim Kasa Profil**  
Slim Case Profile

Paket İçi Adet Quantity Per Package	10	Gramajı Weight	0,218 kg/m
----------------------------------------	----	-------------------	------------

**İçten Gergi**

Internal Tensioner

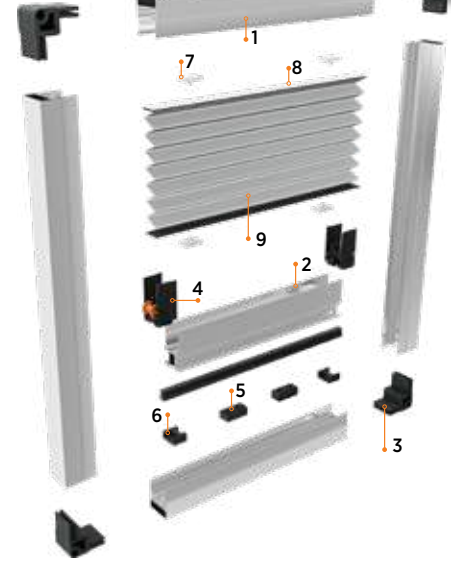

Panjurlu kapı ve pencereler için tasarlanmış bir modeldir. Panjur ile kapı-pencere pervazı arasındaki boşlukta montaj yapılma imkanı sağlamaktadır.

Bu ürün sayesinde panjurlu kapı pencerelerde de sineklik kullanılabilir. 16 mm tül ve banta uygundur.

This wonderful system is designed for Roller shutter doors and windows. It ensures the occasion to be installed in the gap between the shutter and the door-window sill.

Because of its perfect features, the pleated fly screen systems can also be utilized in Roller shutter door and windows. Suitable for 16 mm tulle and tape.

**Alüminyum Renk Seçeneği**

Aluminum Color Options

<b>9016</b> Beyaz White	<b>Eloksal Boyalı</b> Anodized Painted	<b>Bronz Boyalı</b> Bronze Painted
<b>8003</b> Altın Meşe Golden Oak	<b>8016</b> Maun Mahogany	<b>7016</b> Antrasit Gri Anthracite Gray

**İçten Gergi Set İçeriği / Internal Tensioner Set Contents**

No	ÜRÜN KODU Product Code	ÜRÜN ADI Product Name
1	300	<b>Slim Kasa</b> Slim Case
2	358	<b>Slim Kanat</b> Slim Wing
3	PLS 502	<b>Köşe Takozu</b> Corner Wedge
4	PLS 112	<b>Rulman Takımı</b> Bearing Set
5	PLS 114	<b>İp Gergi Takozu</b> Rope Tensioner Chock
6	PLS 113	<b>İp Kontrol Plastiği</b> Rope Control Plastic
7	PLS 550	<b>Delikli Klips</b> Hole Clip
8	PLS 50	<b>PVC Bantlı Şerit</b> PVC Taped Stripe
9	-	<b>Plise Tül</b> Pleated Tulle

**AKS 01 E**  
**AKS 02 E**

**Beyaz / White**  
**Siyah / Black**



**Slim Seri Köşeden Gergi Eşiksiz Aksesuar Seti**  
Slim Series Corner Tensioner Accessory Set without Threshold

Koli İçi Adet Quantity Per Box	100 Set	Renk Color	<input type="checkbox"/>	<input type="checkbox"/>
-----------------------------------	---------	---------------	--------------------------	--------------------------

**358**



**Slim Eşiksiz Kasa Profil**  
Slim Case Profile without Threshold

Paket İçi Adet Quantity Per Package	12	Gramajı Weight	0,111 kg/m
----------------------------------------	----	-------------------	------------

**AKS 03**  
**AKS 04**

**Beyaz / White**  
**Siyah / Black**



**Slim Seri İçten Gergi Aksesuar Seti**  
Slim Serie Internal Tensioner Accessory Set

Koli İçi Adet Quantity Per Box	100 Set	Renk Color	<input type="checkbox"/>	<input type="checkbox"/>
-----------------------------------	---------	---------------	--------------------------	--------------------------

**359**



**Slim Kanat Profil**  
Slim Wing Profile

Paket İçi Adet Quantity Per Package	10	Gramajı Weight	0,321 kg/m
----------------------------------------	----	-------------------	------------

### JUNIOR SERİ PLİSE SİNEKLİK / JUNIOR SERIES PLEATED FLY SCREEN

#### Köşeden Gergi

Corner Tensioner

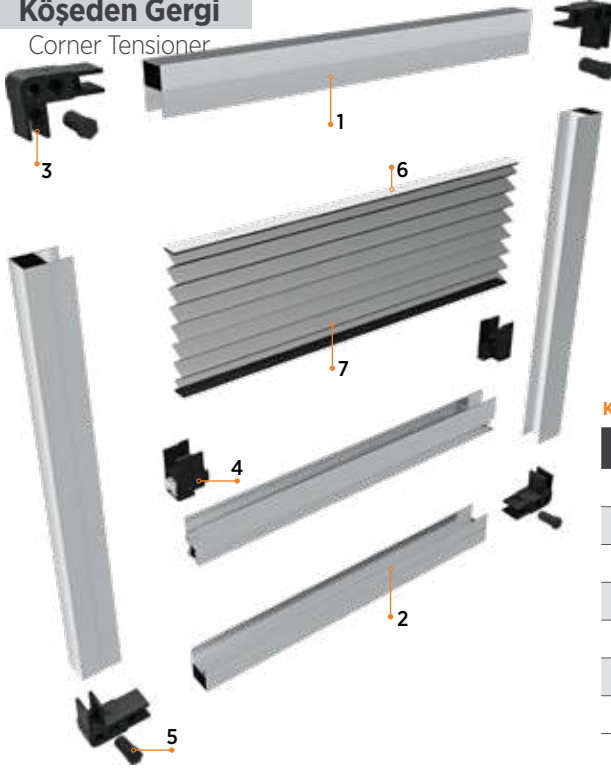

#### Köşeden Gergi Set İçeriği / Corner Tensioner Set Contents

No	ÜRÜN KODU Product Code	ÜRÜN ADI Product Name
1	306	Junior Kasa Profili Junior Case Profile
2	307	Junior Kanat Profili Junior Wing Profile
3	PLS 80	Köşe Takozu Corner Wedge
4	PLS 82	Rulman Takımı Bearing Set
5	PLS 83	Köşe Takozu Pimi Corner Wedge Pin
6	PLS 50-51	PVC Bantlı Şerit PVC Taped Stripe
7	-	Plise Tül Pleated Tulle

Junior Seri, pratik ve estetik bir sineklik çözümü sunar. Köşeden gergi sistemiyle tasarlanan bu model, kullanımı kolay ve dayanıklıdır. Evinize zarif bir görünüm katan Junior Seri, sineklik ihtiyaçlarınızı en iyi şekilde karşılar. 16 ve 19 mm tül ve banta uygundur.

Junior Series offers a practical and aesthetic solution for insect screens. Designed with a corner tensioning system, this model is easy to use and durable. Adding an elegant look to your home, Junior Series meets your insect screen needs perfectly. Suitable for 16 and 19 mm tulle and tape.

AKS 15  
AKS 16

Beyaz / White  
Siyah / Black



#### Junior Seri Köşeden Gergi Aksesuar Seti

Junior Seri Corner Tensioner Accessory Set

Koli İçi Adet Quantity Per Box	100 Set	Renk Color	<input type="checkbox"/>	<input type="checkbox"/>
-----------------------------------	---------	---------------	--------------------------	--------------------------

347



#### Junior Büyük Kasa Profil

Junior Big Case Profile

Paket İçi Adet Quantity Per Package	8	Gramajı Weight	0,445 kg/m
----------------------------------------	---	-------------------	------------

AKS 28  
AKS 29

Beyaz / White  
Siyah / Black



#### Junior Seri Büyük Köşeden Gergi Aksesuar Seti

Junior Seri Big Corner Tensioner Accessory Set

Koli İçi Adet Quantity Per Box	100 Set	Renk Color	<input type="checkbox"/>	<input type="checkbox"/>
-----------------------------------	---------	---------------	--------------------------	--------------------------

AKS 15 E  
AKS 16 E

Beyaz / White  
Siyah / Black



#### Junior Seri Köşeden Gergi Eşiksiz Aksesuar Seti

Junior Seri Corner Tensioner without Threshold Accessory Set

Koli İçi Adet Quantity Per Box	100 Set	Renk Color	<input type="checkbox"/>	<input type="checkbox"/>
-----------------------------------	---------	---------------	--------------------------	--------------------------

306



#### Junior Kasa Profil

Junior Case Profile

Paket İçi Adet Quantity Per Package	10	Gramajı Weight	0,243 kg/m
----------------------------------------	----	-------------------	------------

307



#### Junior Kanat Profil

Nobel Wing Profile

Paket İçi Adet Quantity Per Package	10	Gramajı Weight	0,304 kg/m
----------------------------------------	----	-------------------	------------

345



#### Junior Eşiksiz Kasa Profil

Junior Case Profile without Threshold

Paket İçi Adet Quantity Per Package	12	Gramajı Weight	0,162 kg/m
----------------------------------------	----	-------------------	------------

#### Alüminyum Renk Seçeneği

Aluminum Color Options

9016

Beyaz  
White



Eloksal Boyalı  
Anodized Painted



Bronz Boyalı  
Bronze Painted

8003

Altın Meşe  
Golden Oak

8016

Maun  
Mahogany

7016

Antrasit Gri  
Anthracite Gray

**SÜPER SERİ PLİSE SİNEKLİK / SUPER SERIES PLEATED FLY SCREEN**

**Köşeden Gergi**  
Corner Tensioner

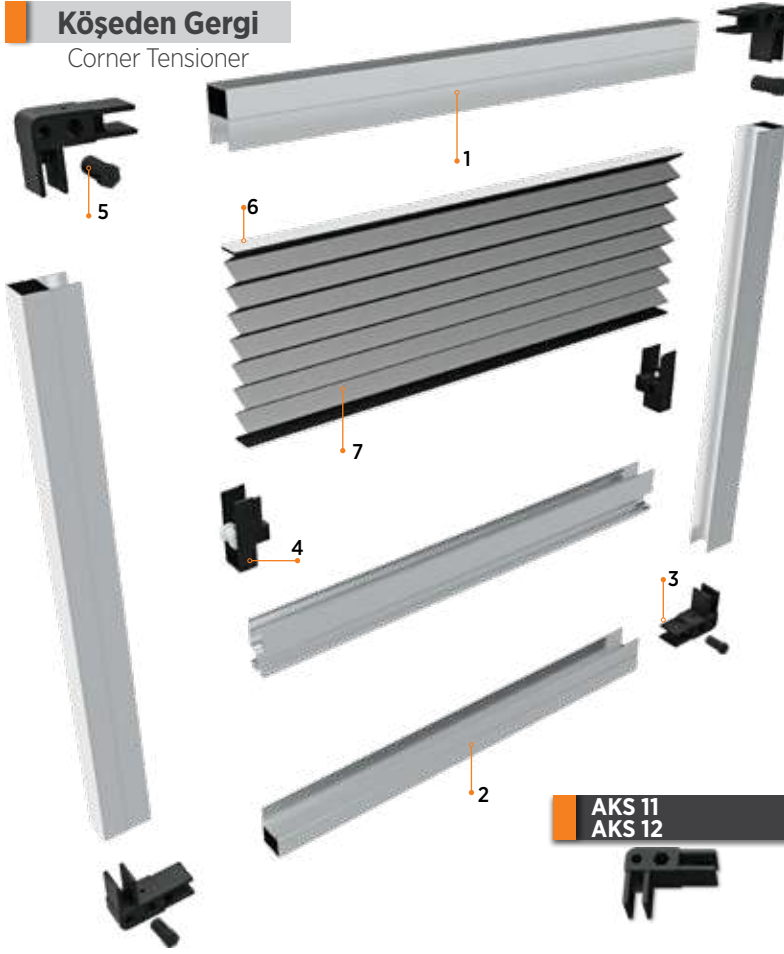

Kapı ve pencereler için tasarlanmış özel bir modeldir. Montajı, panjur ile kapı-pencere pervazı arasındaki boşluğa kolayca yapılabilir. Bu ürün, panjurlu kapı ve pencerelerde de sineklik kullanımını mümkün kılar. 16 mm tül ve banta uygundur.

It is a specially designed model for doors and windows with shutters. It can be easily installed in the space between the shutter and the door-window frame. This product allows the use of insect screens on doors and windows with shutters. Suitable for 16 mm tulle and tape.

**Köşeden Gergi Set İçeriği / Corner Tensioner Set Contents**

No	ÜRÜN KODU Product Code	ÜRÜN ADI Product Name
1	316	Süper Kasa Profili Super Case Profile
2	320	Süper Kanat Profili Super Wing Profile
3	PLS 90	Köşe Takozu Corner Wedge
4	PLS 92	Rulman Takımı Bearing Set
5	PLS 94	Köşe Takozu Pimi Corner Wedge Pin
6	PLS 50	PVC Bantlı Şerit PVC Taped Stripe
7	-	Plise Tül Pleated Tulle



**Süper Seri Köşeden Gergi Aksesuar Seti**  
Super Serie Corner Tensioner Accessory Set

Koli İçi Adet  
Quantity Per Box

100 Set

Renk  
Color



**Süper Seri Köşeden Gergi Eşiksiz Aksesuar Seti**  
Super Series Corner Tensioner Accessory Set without Threshold

Koli İçi Adet  
Quantity Per Box

100 Set

Renk  
Color



**Süper Kanat Profil**  
Super Wing Profile

Paket İçi Adet  
Quantity Per Package

10

Gramajı  
Weight

0,303 kg/m



**Süper Kasa Profil**  
Super Case Profile

Paket İçi Adet  
Quantity Per Package

10

Gramajı  
Weight

0,248 kg/m



**Süper Eşiksiz Kasa Profil**  
Super without Threshold Case Profile

Paket İçi Adet  
Quantity Per Package

12

Gramajı  
Weight

0,469 kg/m

**Alüminyum Renk Seçeneği**  
Aluminum Color Options

**9016**  
Beyaz  
White

**Eloksal Boyalı**  
Anodized Painted

**Bronz Boyalı**  
Bronze Painted

**8003**  
Altın Meşe  
Golden Oak

**8016**  
Maun  
Mahogany

**7016**  
Antrasit Gri  
Anthracite Gray

## SÜPER SERİ PLİSE SİNEKLİK / SUPER SERIES PLEATED FLY SCREEN

### Köşeden Gergi

Corner Tensioner

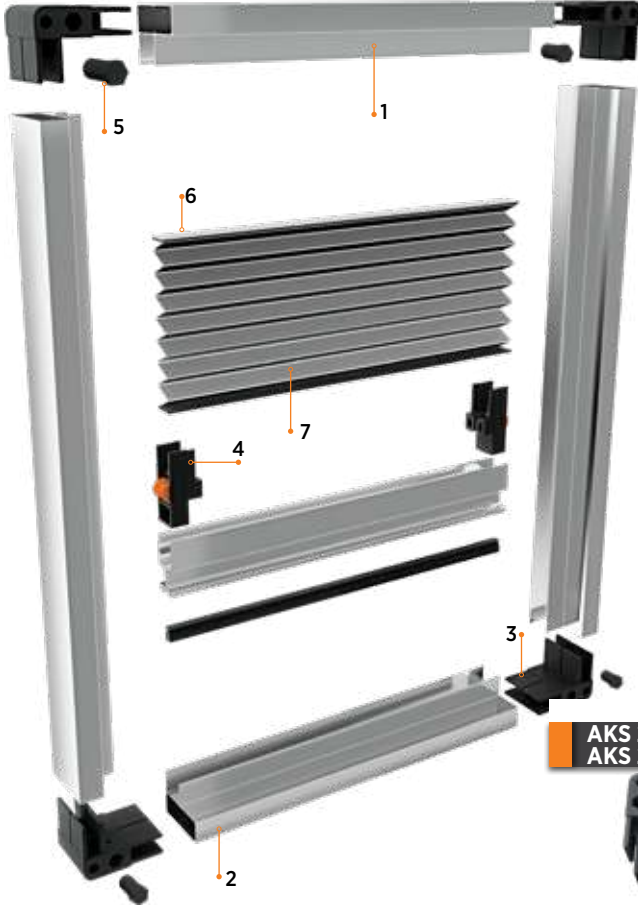

Kapı ve pencereler için tasarlanmış özel bir modeldir. Montajı, panjur ile kapı-pencere pervazı arasındaki boşluğa kolayca yapılabilir. Bu ürün, panjurlu kapı ve pencerelerde de sineklik kullanımını mümkün kılar. 16 mm tül ve banta uygundur.

It is a specially designed model for doors and windows with shutters. It can be easily installed in the space between the shutter and the door-window frame. This product allows the use of insect screens on doors and windows with shutters. Suitable for 16 mm tulle and tape.

### Köşeden Gergi Set İçeriği / Corner Tensioner Set Contents

No	ÜRÜN KODU Product Code	ÜRÜN ADI Product Name
1	354	Süper Kasa Profili Super Case Profile
2	320	Süper Kanat Profili Super Wing Profile
3	PLS 90	Köşe Takoğu Corner Wedge
4	PLS 92	Rulman Takımı Bearing Set
5	PLS 94	Köşe Takoğu Pimi Corner Wedge Pin
6	PLS 50	PVC Bantlı Şerit PVC Taped Stripe
7	-	Plise Tül Pleated Tulle

AKS 26  
AKS 27

Beyaz / White  
Siyah / Black



### Süper Seri Orta Köşeden Gergi Aksesuar Seti Super Serie Middle Corner Tensioner Accessory Set

Koli İçi Adet Quantity Per Box	100 Set	Renk Color	<input type="checkbox"/>	<input type="checkbox"/>
-----------------------------------	---------	---------------	--------------------------	--------------------------

AKS 24  
AKS 25

Beyaz / White  
Siyah / Black



### Süper Seri Büyük Köşeden Gergi Aksesuar Seti Super Serie Big Corner Tensioner Accessory Set

Koli İçi Adet Quantity Per Box	100 Set	Renk Color	<input type="checkbox"/>	<input type="checkbox"/>
-----------------------------------	---------	---------------	--------------------------	--------------------------

320



### Süper Kanat Profil Super Wing Profile

Paket İçi Adet Quantity Per Package	10	Gramajı Weight	0,303 kg/m
----------------------------------------	----	-------------------	------------

354



### Süper Orta Kasa Profil Super Middle Case Profile

Paket İçi Adet Quantity Per Package	8	Gramajı Weight	0,363 kg/m
----------------------------------------	---	-------------------	------------

325



### Süper Büyük Kasa Profil Super Big Case Profile

Paket İçi Adet Quantity Per Package	8	Gramajı Weight	0,469 kg/m
----------------------------------------	---	-------------------	------------

### Alüminyum Renk Seçeneği

Aluminum Color Options

9016

Beyaz  
White



Eloksal Boyalı  
Anodized Painted



Bronz Boyalı  
Bronze Painted

8003

Altın Meşe  
Golden Oak

8016

Maun  
Mahogany

7016

Antrasit Gri  
Anthracite Gray

**NOBEL SERİ PLİSE SİNEKLİK / NOBEL SERIES PLEATED FLY SCREEN**

**Köşeden Gergi**

Corner Tensioner



**Yeni Ürün New Product**

**Köşeden Gergi Set İçeriği / Corner Tensioner Set Contents**

No	ÜRÜN KODU Product Code	ÜRÜN ADI Product Name
1	338	<b>Nobel Kasa Profili</b> Nobel Case Profile
2	335	<b>Nobel Kanat Profili</b> Nobel Wing Profile
3	PLS 120	<b>Nobel Köşe Takozu</b> Nobel Corner Wedge
4	PLS 122	<b>Nobel Rulman Takımı</b> Nobel Bearing Set
5	PLS 610	<b>Nobel Köşe Takozu Kapağı</b> Nobel Corner Wedge Cover
6	PLS 125	<b>Nobel Köşe Takozu Pimi</b> Nobel Corner Wedge Pin
7	PLS 52	<b>PVC Bantlı Şerit</b> PVC Taped Stripe
8	-	<b>Plise Tül</b> Pleated Tulle

Özellikle panjur ve karavan gibi dar alanlarda tercih edilen bir sistemdir. Kasa genişliği diğer serilere göre daha küçüktür. Bu ürünle birlikte panjur sistemlerinde kullanım imkânı sağlayan slim seriyeye alternatif olarak değerlendirilmektedir. 14 mm tül ve banta uygundur.

It is a preferred system, especially in narrow areas such as shutters and caravans. The case width is smaller than that of other series. With this product, it is considered an alternative to the slim series, which provides the opportunity to be used in shutter systems. Suitable for 14 mm tulle and tape.



**Nobel Seri Köşeden Gergi Aksesuar Seti**  
Nobel Serie Corner Tensioner Accessory Set

Koli İçi Adet Quantity Per Box	100 Set	Renk Color	<input type="checkbox"/>	<input type="checkbox"/>
-----------------------------------	---------	---------------	--------------------------	--------------------------



**Nobel Seri Köşeden Gergi Eşiksiz Aksesuar Seti**  
Nobel Serie Corner Tensioner Accessory Set without Threshold

Koli İçi Adet Quantity Per Box	100 Set	Renk Color	<input type="checkbox"/>	<input type="checkbox"/>
-----------------------------------	---------	---------------	--------------------------	--------------------------



**Nobel Kanat Profil**  
Nobel Wing Profile

Paket İçi Adet Quantity Per Package	10	Gramajı Weight	0,345 kg/m
----------------------------------------	----	-------------------	------------



**Nobel Eşiksiz Kasa Profil**  
Nobel Case Profile without Threshold

Paket İçi Adet Quantity Per Package	12	Gramajı Weight	0,098 kg/m
----------------------------------------	----	-------------------	------------



**Nobel Kasa Profil**  
Nobel Case Profile

Paket İçi Adet Quantity Per Package	10	Gramajı Weight	0,250 kg/m
----------------------------------------	----	-------------------	------------

**Alüminyum Renk Seçeneği**

Aluminum Color Options

**9016**

Beyaz  
White



Eloksal Boyalı  
Anodized Painted



Bronz Boyalı  
Bronze Painted

**8003**

Altın Meşe  
Golden Oak

**8016**

Maun  
Mahogany

**7016**

Antrasit Gri  
Anthracite Gray



## NOBEL SERİ PLİSE SİNEKLİK / NOBEL SERIES PLEATED FLY SCREEN

### İçten Montajlı Internal Mounted

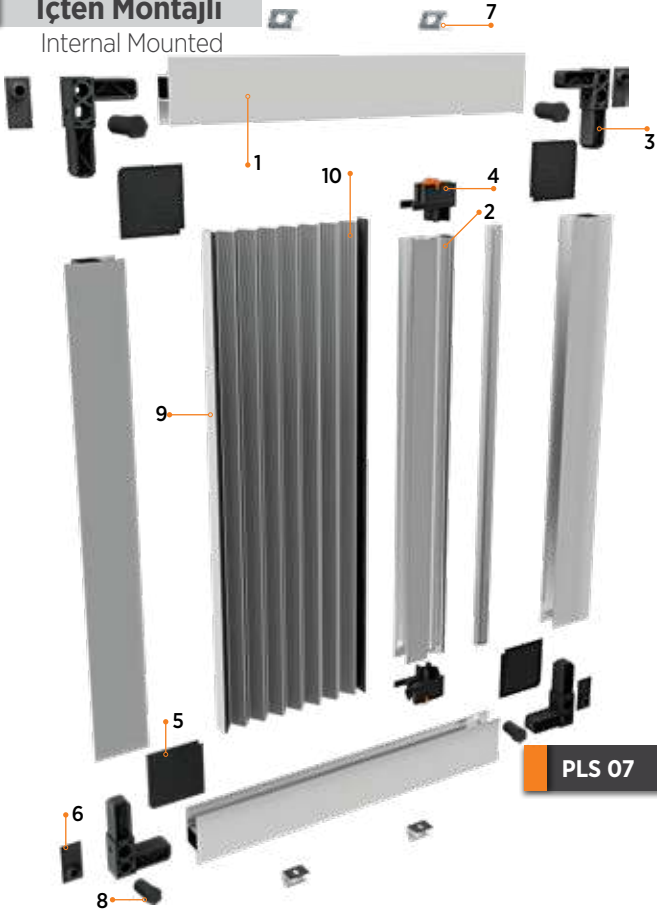

### Yeni Ürün New Product

#### İçten Montaj Set İçeriği / Internal Mounted Set Contents

No	ÜRÜN KODU Product Code	ÜRÜN ADI Product Name
1	363	Nobel İçten/Dıştan Montajlı Kasa Profil Nobel Inside/Outside Mounted Case Profile
2	335	Nobel Kanat Profili Nobel Wing Profile
3	PLS 120	Nobel İçten Montajlı Köşe Takoza Nobel Internally Assembled Corner Wedge
4	PLS 122	Nobel Rulman Takımı Nobel Bearing Set
5	PLS 623	Nobel İçten Montajlı Köşe Takoza Kapağı Nobel Internal Mounted Corner Wedge Cover
6	PLS 610	Nobel Köşe Takoza Kapağı Nobel Corner Wedge Cover
7	PLS 06	Nobel Seri İçten Montajlı Metal Klips Nobel Serial Internally Mounted Metal Clip
8	PLS 125	Nobel Köşe Takoza Pimi Nobel Corner Wedge Pin
9	PLS 52	PVC Bantlı Şerit PVC Taped Stripe
10	-	Plise Tül Pleated Tulle

Montaj alanı dar olan Pvc ve panjur sistemleri için kullanılmaktadır. Sistem içerisinden kolay ve hızlı bir şekilde montajlanabilmektedir. İhtiyaç halinde sökülüp takılabileme imkanı sunar.

It is used for PVC and shutter systems with narrow mounting areas. It can be assembled easily and quickly within the system. It offers the possibility to be disassembled and mounted when needed.

PLS 07



**Nobel Seri Dıştan Montajlı Metal Klips**  
Nobel Serial Externally Mounted Metal Clip

Paket İçi Adet Quantity Per Package	500	Koli İçi Adet Quantity Per Box	500
----------------------------------------	-----	-----------------------------------	-----

PLS 06



**Nobel Seri İçten Montajlı Metal Klips**  
Nobel Serial Internally Mounted Metal Clip

Paket İçi Adet Quantity Per Package	500	Koli İçi Adet Quantity Per Box	500
----------------------------------------	-----	-----------------------------------	-----

335



**Nobel Kanat Profili**  
Nobel Wing Profile

Paket İçi Adet Quantity Per Package	10	Gramajı Weight	0,345 kg/m
----------------------------------------	----	-------------------	------------

363



**Nobel İçten/Dıştan Montajlı Kasa Profili**  
Nobel Inside/Outside Mounted Case Profile

Paket İçi Adet Quantity Per Package	10	Gramajı Weight	0,338 kg/m
----------------------------------------	----	-------------------	------------

AKS 32  
AKS 33

Beyaz / White  
Siyah / Black



**Nobel İçten/Dıştan Montajlı Aksesuar Seti**  
Nobel Inside/Outside Mounted Accessory Set

Koli İçi Adet Quantity Per Box	100 Set	Renk Color	<input type="checkbox"/> <input type="checkbox"/>
-----------------------------------	---------	---------------	---------------------------------------------------

### Alüminyum Renk Seçeneği Aluminum Color Options

9016

Beyaz  
White



Eloksal Boyalı  
Anodized Painted



Bronz Boyalı  
Bronze Painted

8003

Altın Meşe  
Golden Oak

8016

Maun  
Mahogany

7016

Antrasit Gri  
Anthracite Gray

**SLİM SERİ İÇTEN MONTAJLI PLİSE SİNEKLİK / SLIM SERIES INTERNAL MOUNTED PLAIT FLY SCREEN**



**Slim İçten Montajlı Kasa Profil**  
Slim Internal Mounted Case Profile

Paket İçi Adet Quantity Per Package	10	Gramajı Weight	0,272 kg/m
----------------------------------------	----	-------------------	------------



**Slim Kanat Profil**  
Slim Wing Profile

Paket İçi Adet Quantity Per Package	10	Gramajı Weight	0,321 kg/m
----------------------------------------	----	-------------------	------------



**İçten Montajlı Sabit Sineklik Metal Klips**  
Internal Mounted Fixed Fly Screen Metal Clip

Paket İçi Adet Quantity Per Package	500	Koli İçi Adet Quantity Per Box	500
----------------------------------------	-----	-----------------------------------	-----



**Slim Seri İçten Montajlı Köşeden Gergi Aksesuar Seti**  
Slim Series Internally Mounted Corner Tension Accessory Set

Koli İçi Adet Quantity Per Box	100 Set	Renk Color	<input type="checkbox"/> <input type="checkbox"/>
-----------------------------------	---------	---------------	---------------------------------------------------

**Aksesuar İçeriği / Accessory Contents**

No	ÜRÜN KODU Product Code	ÜRÜN ADI Product Name
1	PLS 503	4 Adet - Köşe Takoğu 4 Pices - Corner Wedge
2	PLS 112	2 Adet - Rulman Takımı 2 Pices - Bearing Set
3	PLS 115	2 Adet - Köşe Takoğu Pimi 2 Pices - Corner Wedge Pin
4	PLS 550	8 Adet - Delikli Klips 10 Pices - Hole Clip

**ÖZELLİKLER**  
PROPERTIES

**İçten Takılabilen Plise Sineklik;**  
Internal Mountable Pleated Flyscreen;

Pencere önünde engel olan yerlerde (korkuluk, panjur, çiçeklik, vb.) kullanılır.

Used in areas where there are obstacles in front of windows (railings, window shades, flower beds, etc.).

Yüksek katlarda sinekliğin dışarı açılmasını istemediğiniz durumlarda, montaj için pencere kasasına herhangi bir vida ve atılmasını istemediğiniz durumlarda.

On high floors when you don't want the fly screen to open out and when you don't want to have any screws to the window frame for mounting.

Bütün olumsuzlukları ortadan kaldıran sineklik sistemidir.  
It is a flyscreen systems which eliminates all the problems.

İçten takılabilen sineklik, sabit sineklik olarak vazife görür.  
The flyscreens which can be fitted from the inside, serve as fixed flyscreen.

Klips ile takıldığı için montajda vida kullanılmaz. Montajı çok kolaydır.

It is attached with a clip, no screws are used in assembly. It is very easy to assemble.

Kolayca sökülerek temizliği yapılabilir.  
It can be easily removed and cleaned.



**Alüminyum Renk Seçeneği**  
Aluminum Color Options

**9016**

Beyaz  
White



Eloksal Boyalı  
Anodized Painted



Bronz Boyalı  
Bronze Painted

**8003**

Altın Meşe  
Golden Oak

**8016**

Maun  
Mahogany

**7016**

Antrasit Gri  
Anthracite Gray

## İÇTEN MONTAJLI SABİT SİNEKLİK / INTERNAL MOUNTED FIXED FLY SCREEN



**İçten Montajlı Sabit Sineklik Kasa Profil**  
Internally Mounted Fixed Fly Screen Frame Profile

Paket İçi Adet Quantity Per Package	10	Gramajı Weight	0,256 kg/m
----------------------------------------	----	-------------------	------------



**PRS 32** Beyaz / Siyah  
White / Black

Paket İçi Adet Quantity Per Package	100	Koli İçi Adet Quantity Per Box	500
----------------------------------------	-----	-----------------------------------	-----



**PRS 33**

Paket İçi Adet Quantity Per Package	500	Koli İçi Adet Quantity Per Box	500
----------------------------------------	-----	-----------------------------------	-----



### ÖZELLİKLER

PROPERTIES

#### İçten Takılabilen Sineklik;

Internal Mountable Flyscreen;

Pencere önünde engel olan yerlerde (korkuluk, panjur, çiçeklik, vb.) kullanılır.

Used in areas where there are obstacles in front of windows (railings, window shades, flower beds, etc.).

Yüksek katlarda sinekliğin dışarı açılmasını istemediğiniz durumlarda, montaj için pencere kasasına herhangi bir vida ve atılmasını istemediğiniz durumlarda.

On high floors when you don't want the fly screen to open out and when you don't want to have any screws to the window frame for mounting.

Bütün olumsuzlukları ortadan kaldıran sineklik sistemidir.

It is a flyscreen systems which eliminates all the problems.

İçten takılabilen sineklik, sabit sineklik olarak vazife görür.

The flyscreens which can be fitted from the inside, serve as fixed flyscreen.

Klips ile takıldığı için montajda vida kullanılmaz. Montajı çok kolaydır.

It is attached with a clip, no screws are used in assembly. It is very easy to assemble.

Kolayca sökülerek temizliği yapılabilir.

It can be easily removed and cleaned.

#### Alüminyum Renk Seçeneği

Aluminum Color Options

**9016**

Beyaz  
White



Eloksal Boyalı  
Anodized Painted



Bronz Boyalı  
Bronze Painted

**8003**

Altın Meşe  
Golden Oak

**8016**

Maun  
Mahogany

**7016**

Antrasit Gri  
Anthracite Gray

ÜRÜN ADI Product Name	ÜRÜN KODU Product Code			Paket m <sup>2</sup> Package m <sup>2</sup>			KOLİ İÇİ ADET (m <sup>2</sup> ) Quantity Per Box (m <sup>2</sup> )		
	14 mm	16 mm	19 mm	14 mm	16 mm	19 mm	14 mm	16 mm	19 mm
<b>Pile Yüksekliği</b> Plait Height									
<b>190cm Plise Polyester Tül</b> 190cm Plait Polyester Tulle	<b>190-14 P</b>	<b>190-16 P</b>	<b>190-19 P</b>	49 m <sup>2</sup>	57 m <sup>2</sup>	68 m <sup>2</sup>	294 m <sup>2</sup>	285 m <sup>2</sup>	272 m <sup>2</sup>
<b>200cm Plise Polyester Tül</b> 200cm Plait Polyester Tulle	<b>200-14 P</b>	<b>200-16 P</b>	<b>200-19 P</b>	52 m <sup>2</sup>	60 m <sup>2</sup>	72 m <sup>2</sup>	312 m <sup>2</sup>	300 m <sup>2</sup>	288 m <sup>2</sup>
<b>210cm Plise Polyester Tül</b> 210cm Plait Polyester Tulle	<b>210-14 P</b>	<b>210-16 P</b>	<b>210-19 P</b>	55 m <sup>2</sup>	63 m <sup>2</sup>	76 m <sup>2</sup>	330 m <sup>2</sup>	315 m <sup>2</sup>	304 m <sup>2</sup>
<b>220cm Plise Polyester Tül</b> 220cm Plait Polyester Tulle	<b>220-14 P</b>	<b>220-16 P</b>	<b>220-19 P</b>	57 m <sup>2</sup>	66 m <sup>2</sup>	79 m <sup>2</sup>	342 m <sup>2</sup>	330 m <sup>2</sup>	316 m <sup>2</sup>
<b>240cm Plise Polyester Tül</b> 240cm Plait Polyester Tulle	<b>240-14 P</b>	<b>240-16 P</b>	<b>240-19 P</b>	62 m <sup>2</sup>	72 m <sup>2</sup>	86 m <sup>2</sup>	372 m <sup>2</sup>	360 m <sup>2</sup>	344 m <sup>2</sup>
<b>270cm Plise Polyester Tül</b> 270cm Plait Polyester Tulle	<b>270-14 P</b>	<b>270-16 P</b>	<b>270-19 P</b>	70 m <sup>2</sup>	81 m <sup>2</sup>	97 m <sup>2</sup>	420 m <sup>2</sup>	405 m <sup>2</sup>	388 m <sup>2</sup>
<b>300cm Plise Polyester Tül</b> 300cm Plait Polyester Tulle	<b>300-14 P</b>	<b>300-16 P</b>	<b>300-19 P</b>	78 m <sup>2</sup>	90 m <sup>2</sup>	108 m <sup>2</sup>	468 m <sup>2</sup>	450 m <sup>2</sup>	432 m <sup>2</sup>

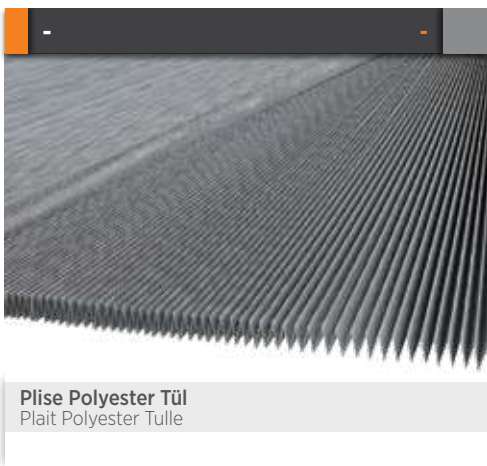

**Pile yüksekliği: 14 mm, 16 mm ve 19 mm ölçülerinde stoklarımızda mevcuttur.**

**A ve B kalitede satışa sunulmaktadır.**

**Plait height: Available in stock in sizes of 14 mm, 16 mm, and 19 mm.**

**Available for sale in A and B quality.**

ÜRÜN ADI Product Name	ÜRÜN KODU Product Code		Paket m <sup>2</sup> Package m <sup>2</sup>		KOLİ İÇİ ADET (m <sup>2</sup> ) Quantity Per Box (m <sup>2</sup> )	
	14 mm	16 mm	14 mm	16 mm	14 mm	16 mm
<b>Pile Yüksekliği</b> Plait Height	14 mm	16 mm	14 mm	16 mm	14 mm	16 mm
<b>200cm Plise Fiber Tül</b> 200cm Plait Fiber Tulle	200-14 F	200-16 F	60 m <sup>2</sup>	50 m <sup>2</sup>	300 m <sup>2</sup>	250 m <sup>2</sup>
<b>210cm Plise Fiber Tül</b> 210cm Plait Fiber Tulle	-	210-16 F	-	52,5 m <sup>2</sup>	-	262,5 m <sup>2</sup>
<b>220cm Plise Fiber Tül</b> 220cm Plait Fiber Tulle	220-14 F	220-16 F	66 m <sup>2</sup>	55 m <sup>2</sup>	330 m <sup>2</sup>	275 m <sup>2</sup>
<b>240cm Plise Fiber Tül</b> 240cm Plait Fiber Tulle	240-14 F	240-16 F	72 m <sup>2</sup>	60 m <sup>2</sup>	360 m <sup>2</sup>	300 m <sup>2</sup>
<b>270cm Plise Fiber Tül</b> 270cm Plait Fiber Tulle	270-14 F	270-16 F	81 m <sup>2</sup>	67,5 m <sup>2</sup>	405 m <sup>2</sup>	337,5 m <sup>2</sup>
<b>300cm Plise Fiber Tül</b> 300cm Plait Fiber Tulle	300-14 F	300-16 F	90 m <sup>2</sup>	75 m <sup>2</sup>	450 m <sup>2</sup>	375 m <sup>2</sup>

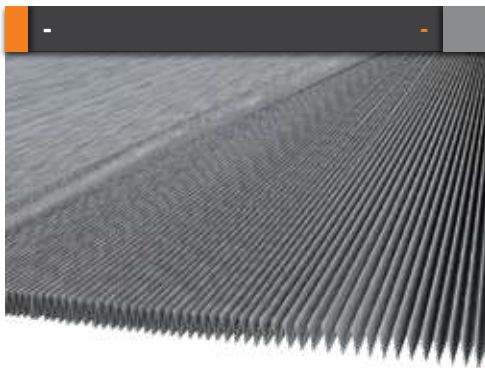

Plise Fiber Tül  
Plait Fiber Tulle

**Pile yüksekliği: 14 mm ve 16 mm ölçülerinde stoklarımızda mevcuttur.**

**Plait height: Available in stock in sizes of 14 mm and 16 mm.**

PLS 11-4



**Kuş Gözü (Metal) 4 mm**  
Rivet (Metal) 4 mm

Koli İçi Adet Quantity Per Box	5.000
-----------------------------------	-------

PLS 11-5



**Kuş Gözü (Metal) - 5 mm**  
Rivet (Metal) - 5 mm

Koli İçi Adet Quantity Per Box	5.000
-----------------------------------	-------

PLS 12



**Plise İpi**  
Pleat Yarn

Paket İçi Adet Quantity Per Package	1 Top * 500 m	Koli İçi Adet Quantity Per Box	12
----------------------------------------	---------------	-----------------------------------	----

PLS 52



**PVC Bantlı Şerit 12/13 mm**  
PVC Taped Stripe 12/13 mm

Paket İçi Adet Quantity Per Package	1 Top * 500 m	Koli İçi Adet Quantity Per Box	10
----------------------------------------	---------------	-----------------------------------	----

PLS 50



**PVC Bantlı Şerit 16 mm**  
PVC Taped Stripe 16 mm

Paket İçi Adet Quantity Per Package	1 Top * 500 m	Koli İçi Adet Quantity Per Box	10
----------------------------------------	---------------	-----------------------------------	----

PLS 51



**PVC Bantlı Şerit 18/19 mm**  
PVC Taped Stripe 18/19 mm

Paket İçi Adet Quantity Per Package	1 Top * 500 m	Koli İçi Adet Quantity Per Box	10
----------------------------------------	---------------	-----------------------------------	----

PLS 14



**PVC Siyah Şerit**  
PVC Black Stripe

Paket İçi Adet Quantity Per Package	1 Top * 100 m	Koli İçi Adet Quantity Per Box	10
----------------------------------------	---------------	-----------------------------------	----

PLS 14-A



**PVC Yeşil Şerit 16mm**  
PVC Green Stripe 16mm

Paket İçi Adet Quantity Per Package	1 Top * 1.400 m
----------------------------------------	-----------------

PLS 14-B



**PVC Yeşil Şerit 19mm**  
PVC Green Stripe 19mm

Paket İçi Adet Quantity Per Package	1 Top * 1.000 m
----------------------------------------	-----------------

PLS 45



**Premium PVC Bantlı Şerit 12/13 mm**  
Premium PVC Taped Stripe 12/13 mm

Paket İçi Adet Quantity Per Package	1 Top * 500 m	Koli İçi Adet Quantity Per Box	10
----------------------------------------	---------------	-----------------------------------	----

PLS 46



**Premium PVC Bantlı Şerit 16 mm**  
Premium PVC Taped Stripe 16 mm

Paket İçi Adet Quantity Per Package	1 Top * 500 m	Koli İçi Adet Quantity Per Box	10
----------------------------------------	---------------	-----------------------------------	----

PLS 47



**Premium PVC Bantlı Şerit 18/19 mm**  
Premium PVC Taped Stripe 18/19 mm

Paket İçi Adet Quantity Per Package	1 Top * 500 m	Koli İçi Adet Quantity Per Box	10
----------------------------------------	---------------	-----------------------------------	----

# PLİSE SİNEKLİK SİSTEMLERİ AKSESUARLARI

Pleated Fly Screen Systems Accessories

PLS 53



**Çift Taraflı Bant**  
Double Sided Band

Paket İçi Adet  
Quantity Per Package

1 Top \* 50 m

PLS 22



**Mıknatıs**  
Magnet

Paket İçi Adet  
Quantity Per Package

16 kg

Koli İçi Adet  
Quantity Per Box

≈175 m

PRD 31



**Kumaş Delme Makinesi**  
Fabric Punching Machine



**PLATİN SÜRME SİNEKLİK / PLATIN SLIDING FLY SCREEN**

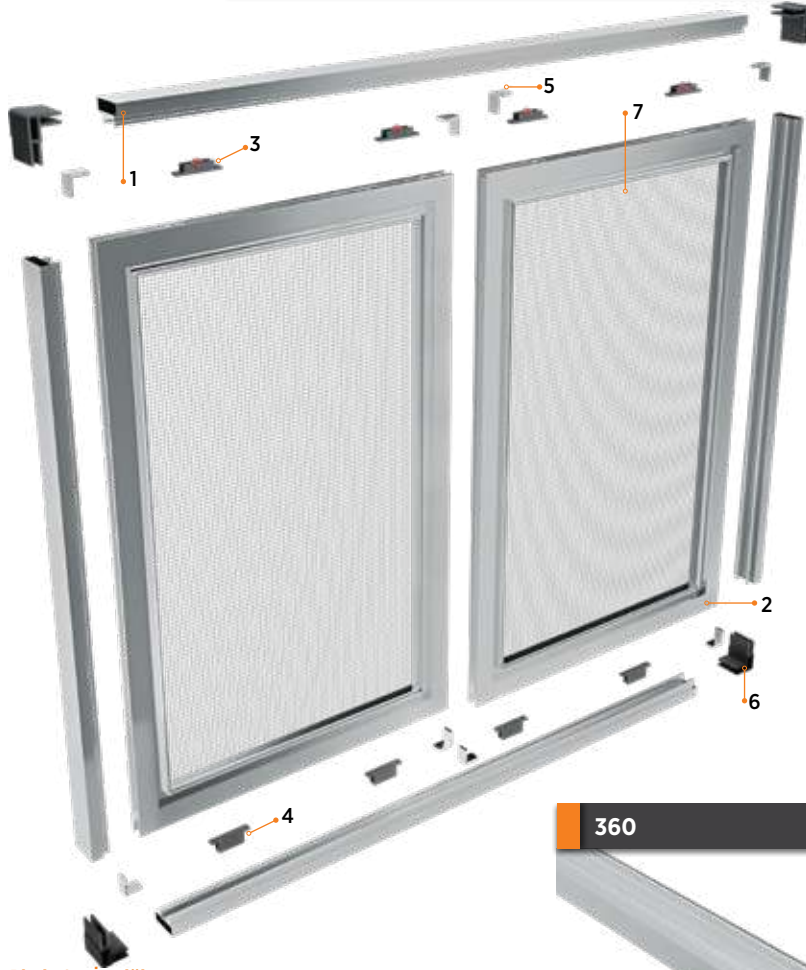

**Platin Set İçeriği / Platin Set Contents**

No	ÜRÜN KODU Product Code	ÜRÜN ADI Product Name
1	321/322	Kasa Profil Case Profile
2	323	Kanat Profil Wing Profile
3	PLT 05	Denge Plastiği Balance Plastic
4	PLT 04	Rulmanlı Teker Bearing Wheel
5	PLT 03	Alüminyum Köşe Takozu Aluminum Corner Wedge
6	PLT 02	Plastik Köşe Takozu Plastic Corner Wedge
7	-	Sineklik Tülü Flynet Tulle



Platin Tekli Kasa Profil Platin Series Single Frame Profile			
Paket İçi Adet Quantity Per Package	8	Gramajı Weight	0,352 kg/m



Platin Tekli Dar Kasa Profil Platin Series Single Slim Frame Profile			
Paket İçi Adet Quantity Per Package	8	Gramajı Weight	0,306 kg/m



Platin Çiftli Kasa Profile Platin Series Double Frame Profile			
Paket İçi Adet Quantity Per Package	6	Gramajı Weight	0,455 kg/m



Platin Seri Aksesuar Seti Platin Serie Accessory Set			
Koli İçi Adet Quantity Per Box	50 Set	Renk Color	Siyah Black

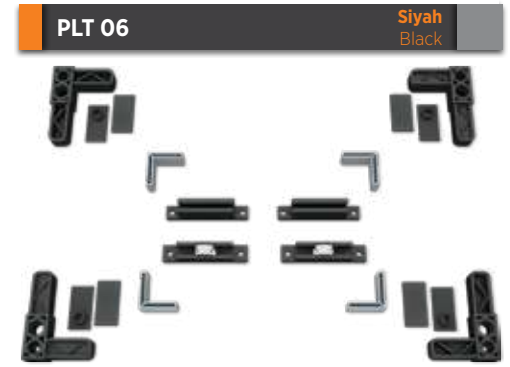

Platin Tekli Dar Aksesuar Seti Platin Series Single Slim Accessory Set			
Koli İçi Adet Quantity Per Box	50 Set	Renk Color	Siyah Black



Platin Kanat Profil Platin Series Sash Profile			
Paket İçi Adet Quantity Per Package	10	Gramajı Weight	0,506 kg/m

**Alüminyum Renk Seçeneği**  
Aluminum Color Options

**9016**  
Beyaz  
White

Eloksal Boyalı  
Anodized Painted

Bronz Boyalı  
Bronze Painted

**8003**  
Altın Meşe  
Golden Oak

**8016**  
Maun  
Mahogany

**7016**  
Antrasit Gri  
Anthracite Gray



## AYKİM SÜRME SİNEKLİK / AYKİM SLIDING FLY SCREEN

PRS 37

Beyaz / Altın Meşe / Siyah  
White / Golden oak / Black



**Aykim Makarasız Köşe**  
Aykim Corner whitout Roll

Paket İçi Adet Quantity Per Package	50	Koli İçi Adet Quantity Per Box	500
----------------------------------------	----	-----------------------------------	-----

PRS 36

Beyaz / Altın Meşe / Siyah  
White / Golden oak / Black



**Aykim Makaralı Köşe**  
Aykim Corner whit Roll

Paket İçi Adet Quantity Per Package	50	Koli İçi Adet Quantity Per Box	500
----------------------------------------	----	-----------------------------------	-----

PRS 38

Beyaz / Altın Meşe / Siyah  
White / Golden oak / Black



**Aykim Kasa Takozu**  
Aykim Wedge

Paket İçi Adet Quantity Per Package	100	Koli İçi Adet Quantity Per Box	1.000
----------------------------------------	-----	-----------------------------------	-------

309



**Aykim Kasa Profil**  
Aykim Case Profile

Paket İçi Adet Quantity Per Package	8	Gramajı Weight	0,374 kg/m
----------------------------------------	---	-------------------	------------

310



**Aykim Kanat Profil**  
Aykim Wing Profile

Paket İçi Adet Quantity Per Package	10	Gramajı Weight	0,315 kg/m
----------------------------------------	----	-------------------	------------

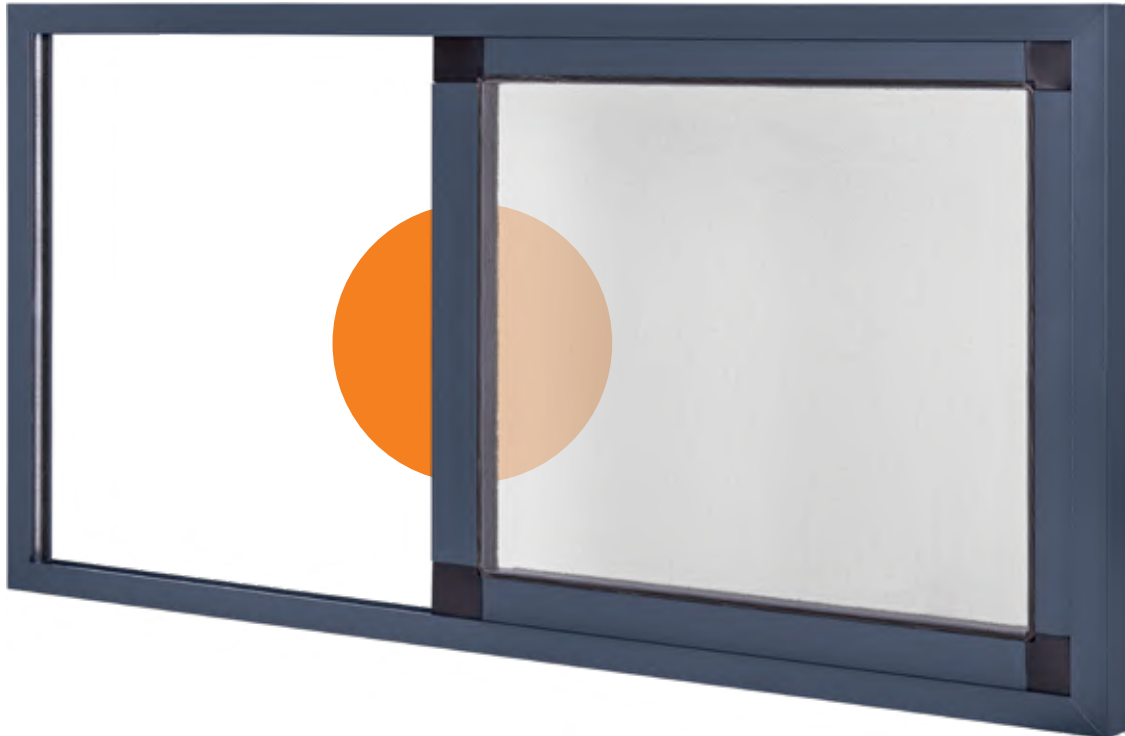

**Alüminyum Renk Seçeneği**

Aluminum Color Options

9016

Beyaz  
White



Eloksoal Boyalı  
Anodized Painted



Bronz Boyalı  
Bronze Painted

8003

Altın Meşe  
Golden Oak

8016

Maun  
Mahogany

7016

Antrasit Gri  
Anthracite Gray



Stor Set İçeriği / Stor Set Contents

No	ÜRÜN KODU Product Code	ÜRÜN ADI Product Name
1	409	Üst Kasa Profil Upper Case Profile
2	410	Yan Kasa Profil Side Case Profile
3	411	Alt Kasa Profil Bottom Case Profile
4	407	Kanat Profil Wing Profile
5	408	Tül Boru Profil Tulle Pipe Profile
6	-	Stor Tül Stor Tulle
7	STR 100	Fren Köşe Plastiği Brake Corner Plastic
8	STR 101	Yay Köşe Plastiği Spring Corner Plastic
9	-	Yay Spring
10	STR 102	Yay Kapama Boru Plastiği Spring Closure Pipe Plastic
11	STR 103	Yay Sabitleme Plastiği Spring Fixing Plastic
12	STR 104	Kasa Birleştirme Plastiği Case Joining Plastic
13	STR 105	Kulp Handle
14	STR 106	İp Tutma Aparatı Rope Holder
15	STR 107	Kanat Kapağı Wing Cover
16	STR 02	Fren Sistemi Brake System
17	Fitil 24	Kıl Fitil Brush Seal



STR 01

Beyaz / Siyah  
White / Black



**Stor Sineklik Aksesuar Seti**  
Stor Fly Screen Accessory Set

Paket İçi Adet Quantity Per Package	1 Set	Koli İçi Adet Quantity Per Box	50 Set
----------------------------------------	-------	-----------------------------------	--------

STR 02

Siyah  
Black



**Stor Sineklik Fren Sistemi**  
Stor Fly Screen Brake Profile

Paket İçi Adet Quantity Per Package	50	Koli İçi Adet Quantity Per Box	50
----------------------------------------	----	-----------------------------------	----

Fitul 24



**67x650 Kıl Fitol**  
67x650 Brush Seal

Paket İçi Adet Quantity Per Package	350 m	Koli İçi Adet Quantity Per Box	1.400 m
----------------------------------------	-------	-----------------------------------	---------

STR 03



**Stor Kaset 160 cm**  
Cassette 160 cm

Paket İçi Adet Quantity Per Package	1 Set
----------------------------------------	-------

410



**Stor Sineklik Yan Kasa Profil**  
Stor Fly Screen Side Case Profile

Paket İçi Adet Quantity Per Package	6	Gramajı Weight	0,413 kg/m
----------------------------------------	---	-------------------	------------

411



**Stor Sineklik Alt Kasa Profil**  
Stor Fly Screen Bottom Case Profile

Paket İçi Adet Quantity Per Package	6	Gramajı Weight	0,318 kg/m
----------------------------------------	---	-------------------	------------



- Yay mekanizmalı ve geri sarmalı olarak tasarlandı.
- Alt kasa aynı zamanda sineklik ekranını kilitleyecek şekilde tırnaklı olarak tasarlandı.
- Alüminyum kanat alt kasa tırnaklarından ayrıldığı anda sarım profili içerisindeki kurulmuş olan yay, sineklik tülünü üst kasa içerisinde geri sarım yaparak toplar. Bu toplama esnasında hidrolik fren devreye girer. Böylece sarım yavaş ve düzgün olur.
- Sinekliğin çerçevesini oluşturan profiller aynı zamanda kasa profili olarak dizayn edildi. Üst kasa, yan kasa ve alt kasa profilleri 4 adet takoz ile birleştirildi.
- Sistem kurulur. Köşe takozlarındaki kanallardan yapılan vidalama ile sistem yerine montajlanır. İşte bu kadar basit!

- It is designed with a spring mechanism and rewind.
- The bottom case is also designed with tabs to lock the fly screen.
- When the aluminum wing is separated from the lower case tabs, the spring installed in the winding profile collects the fly net in the upper case by rewinding. During this collection, the hydraulic brake is activated. Thus, the winding is slow and smooth.
- The profiles forming the frame of the fly screen were also designed as frame profiles. Upper case, side case, and lower case profiles were combined with 4 wedges.
- The system is easily installed. The installation is accomplished by screwing through the channels in the corner wedges. That's all it takes!

**Alüminyum Renk Seçeneği**

Aluminum Color Options

9016

Beyaz  
White



Eloksal Boyalı  
Anodized Painted



Bronz Boyalı  
Bronze Painted

8003

Altın Meşe  
Golden Oak

8016

Maun  
Mahogany

7016

Antrasit Gri  
Anthracite Gray



Ahşap  
Wooden

PRS 01



**17x25 Sineklik Köşe Takozu**  
17x25 Flynet Corner Wedge

Paket İçi Adet Quantity Per Package	100	Koli İçi Adet Quantity Per Box	1.000
----------------------------------------	-----	-----------------------------------	-------

PRS 02



**17x25 Sineklik Mentеше (Plastik Pimli)**  
17x25 Flynet Plastic Hinge (with Plastic Pin)

Paket İçi Adet Quantity Per Package	100	Koli İçi Adet Quantity Per Box	2.000
----------------------------------------	-----	-----------------------------------	-------

PRS 04



**17x25 Sineklik Tutamak**  
17x25 Flynet Handle

Paket İçi Adet Quantity Per Package	100	Koli İçi Adet Quantity Per Box	1.500
----------------------------------------	-----	-----------------------------------	-------

PRS 05



**17x25 Sineklik Çıtçıt**  
17x25 Flynet Gripper

Paket İçi Adet Quantity Per Package	100	Koli İçi Adet Quantity Per Box	2.000
----------------------------------------	-----	-----------------------------------	-------

PRS 06



**17x25 Sineklik Bağlama Pabucu**  
17x25 Flynet Fastening Plate

Paket İçi Adet Quantity Per Package	50	Koli İçi Adet Quantity Per Box	500
----------------------------------------	----	-----------------------------------	-----

PRS 07



**10x20 Sineklik Köşe Takozu**  
10x20 Flynet Corner Wedge

Paket İçi Adet Quantity Per Package	100	Koli İçi Adet Quantity Per Box	2.500
----------------------------------------	-----	-----------------------------------	-------

PRS 08



**10x20 Sineklik Mentеше (Plastik Pimli)**  
10x20 Flynet Plastic Hinge (with Plastic Pin)

Paket İçi Adet Quantity Per Package	100	Koli İçi Adet Quantity Per Box	2.000
----------------------------------------	-----	-----------------------------------	-------

PRS 10



**10x20 Sineklik Tutamak**  
10x20 Flynet Handle

Paket İçi Adet Quantity Per Package	100	Koli İçi Adet Quantity Per Box	3.000
----------------------------------------	-----	-----------------------------------	-------

PRS 11



**10x20 Sineklik Çıtçıt**  
10x20 Flynet Gripper

Paket İçi Adet Quantity Per Package	100	Koli İçi Adet Quantity Per Box	3.000
----------------------------------------	-----	-----------------------------------	-------

PRS 12



**10x20 Sineklik Bağlama Pabucu**  
10x20 Flynet Fastening Plate

Paket İçi Adet Quantity Per Package	50	Koli İçi Adet Quantity Per Box	500
----------------------------------------	----	-----------------------------------	-----

PRS 13



**10x20 Sineklik Tutma Halkası**  
10x20 Flynet Holding Ring

Paket İçi Adet Quantity Per Package	100	Koli İçi Adet Quantity Per Box	2.500
----------------------------------------	-----	-----------------------------------	-------

PRS 14



**10x20 Sineklik Tutma Halkası Altı**  
10x20 Flynet Holding Ring Bottom Part

Paket İçi Adet Quantity Per Package	100	Koli İçi Adet Quantity Per Box	2.500
----------------------------------------	-----	-----------------------------------	-------

# 17-25 / 10-20 SİNEKLİK SİSTEM AKSESUARLARI

17-25 / 10-20 Fly Screen System Accessories

PRS 15



**20x40 Sineklik Köşe Takozu**  
20x40 Flynet Corner Wedge

Paket İçi Adet Quantity Per Package	50	Koli İçi Adet Quantity Per Box	600
----------------------------------------	----	-----------------------------------	-----

PRS 16



**10x20 Sineklik Köşe Takozu 45°**  
10x20 Flynet Corner Wedge 45°

Paket İçi Adet Quantity Per Package	100	Koli İçi Adet Quantity Per Box	2.000
----------------------------------------	-----	-----------------------------------	-------

PRS 17



**17x25 Sineklik Köşe Takozu 45°**  
17x25 Flynet Corner Wedge 45°

Paket İçi Adet Quantity Per Package	100	Koli İçi Adet Quantity Per Box	600
----------------------------------------	-----	-----------------------------------	-----

PRS 26



**Sineklik Köşe Mukavemet Takozu**  
Flynet Corner Strength Wedge

Paket İçi Adet Quantity Per Package	100	Koli İçi Adet Quantity Per Box	1.500
----------------------------------------	-----	-----------------------------------	-------

PRS 24



**Plastik "D" Kol**  
Plastic "D" Handle

Paket İçi Adet Quantity Per Package	50	Koli İçi Adet Quantity Per Box	600
----------------------------------------	----	-----------------------------------	-----

PRS 30



**Plastik "C" Kol**  
Plastic "C" Handle

Paket İçi Adet Quantity Per Package	100	Koli İçi Adet Quantity Per Box	1.500
----------------------------------------	-----	-----------------------------------	-------

PRS 27

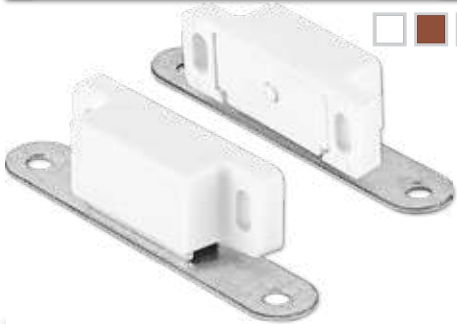

**Mıknatıslı Çıtçı**  
Gripper with Magnet

Paket İçi Adet Quantity Per Package	100	Koli İçi Adet Quantity Per Box	500
----------------------------------------	-----	-----------------------------------	-----

PRS 19



**Sineklik Fitolü (Beyaz)**  
Flynet Seal (White)

Paket İçi Adet Quantity Per Package	15	Koli İçi Adet Quantity Per Box	1.500 m
----------------------------------------	----	-----------------------------------	---------

PRS 29



**Sineklik Takma Aparatı 3'lü**  
Triple Flynet Mounting Apparatus

Paket İçi Adet Quantity Per Package	20	Koli İçi Adet Quantity Per Box	100
----------------------------------------	----	-----------------------------------	-----

PRS 37



**Aykim Makarasız Köşe**  
Aykim Corner without Pulley

Paket İçi Adet Quantity Per Package	50	Koli İçi Adet Quantity Per Box	500
----------------------------------------	----	-----------------------------------	-----

PRS 36



**Aykim Makaralı Köşe**  
Aykim Corner with Pulley

Paket İçi Adet Quantity Per Package	50	Koli İçi Adet Quantity Per Box	500
----------------------------------------	----	-----------------------------------	-----

PRS 38



**Aykim Kasa Takozu**  
Aykim Wedge

Paket İçi Adet Quantity Per Package	100	Koli İçi Adet Quantity Per Box	1.000
----------------------------------------	-----	-----------------------------------	-------

PRS 25



**Cam Küreği**  
Glass Paddle

Koli İçi Adet  
Quantity Per Box

150

PSS 8



**Paslanmaz Lüks Teker**  
Stainless Luxury Wheel

Koli İçi Adet  
Quantity Per Box

200

ZZ 29



**Emniyet Kilidi**  
Safety Lock

Koli İçi Adet  
Quantity Per Box

150

ZZ 32



**Pimli Emniyet Kilidi**  
Safety Lock with Pin

Koli İçi Adet  
Quantity Per Box

150

ZZ 39



**Halatlı Emniyet Kilidi**  
Safety Lock with Rope

Koli İçi Adet  
Quantity Per Box

100

ZZ 26



**Teflon Bant**  
Teflon Tape

Koli İçi Adet  
Quantity Per Box

50 m

**Cam Takozları**

**Glass Wedges**



**ÜRÜN ADI**

Product Name

**ÜRÜN KODU**

Product Code

**KOLİ İÇİ ADET**

Quantity Per Box

2mmx20mmx80mm

ACT 6

20.000

5mmx20mmx80mm

ACT 7

12.000

5mmx25mmx80mm

ACT 9

10.000

5mmx28mmx80mm

ACT 10

10.000

5mmx32mmx80mm

ACT 11

5.000

## DESTEK SACLI 90 mm PLASTİK KAPI MENTEŞESİ

90 mm Plastic Door Hinge with Support Sheet

ÜRÜN ADI Product Name	ÜRÜN KODU Product Code	KOLİ İÇİ ADET Quantity Per Box
Beyaz 9016 / White 9016	SM 90 9016	150
Altın Meşe 8003 / Golden Oak 8003	SM 90 8003	150
Maun 8016 / Mahogany 8016	SM 90 8016	150
Antrasit Gri 7016 / Anthracite Gray 7016	SM 90 7016	150
Siyah 9005 / Black 9005	SM 90 9005	150



### ÖZELLİKLER

PROPERTIES

1,2 mm galvaniz kaplamalı çelik sac ile desteklenmiştir.  
Supported by 1,2 mm galvanized steel sheet.

İç yapısındaki sac desteği sayesinde zamak menteşelere göre taşıma kapasitesi daha yüksektir.  
Thanks to the sheet metal support in the internal structure, a higher carrying capacity is obtained, compared to the zamak hinges.

Kanatlarda sarkma problemini tamamen ortadan kaldırır.  
It completely eliminates the problem of sagging in the wings.



1,2 mm galvaniz kaplamalı  
çelik sac (90 mm)

1,2 mm galvanized  
steel sheet (90 mm)

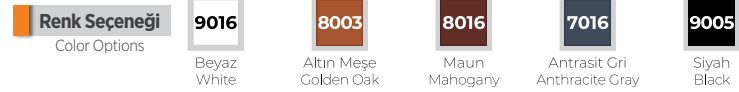

## DESTEK SACLI 75 mm PLASTİK PENCERE MENTEŞESİ

75 mm Plastic Window Hinge with Support Sheet

ÜRÜN ADI Product Name	ÜRÜN KODU Product Code	KOLİ İÇİ ADET Quantity Per Box
Beyaz 9016 / White 9016	SM 75 9016	150
Altın Meşe 8003 / Golden Oak 8003	SM 75 8003	150
Maun 8016 / Mahogany 8016	SM 75 8016	150
Antrasit Gri 7016 / Anthracite Gray 7016	SM 75 7016	150
Siyah 9005 / Black 9005	SM 75 9005	150



### ÖZELLİKLER

PROPERTIES

1,2 mm galvaniz kaplamalı çelik sac ile desteklenmiştir.  
Supported by 1,2 mm galvanized steel sheet.

İç yapısındaki sac desteği sayesinde zamak menteşelere göre taşıma kapasitesi daha yüksektir.  
Thanks to the sheet metal support in the internal structure, a higher carrying capacity is obtained, compared to the zamak hinges.

Kanatlarda sarkma problemini tamamen ortadan kaldırır.  
It completely eliminates the problem of sagging in the wings.



1,2 mm galvaniz kaplamalı  
çelik sac (75 mm)

1,2 mm galvanized  
steel sheet (75 mm)



**Gold Baza Profil**  
Gold Base Profile

Paket İçi Adet Quantity Per Package	3	Gramajı Weight	0,717 kg/m
----------------------------------------	---	-------------------	------------



**Firtına Baza Profil**  
Firtına Base Profile

Paket İçi Adet Quantity Per Package	3	Gramajı Weight	0,730 kg/m
----------------------------------------	---	-------------------	------------



**Oluklu Kasa Profil**  
Corrugated Case Profile

Paket İçi Adet Quantity Per Package	3	Gramajı Weight	1,396 kg/m
----------------------------------------	---	-------------------	------------



**Düz Kasa Profil**  
Flat Case Profile

Paket İçi Adet Quantity Per Package	3	Gramajı Weight	1,355 kg/m
----------------------------------------	---	-------------------	------------



**Oluklu Büyük Kasa Profil**  
Corrugated Big Case Profile

Paket İçi Adet Quantity Per Package	3	Gramajı Weight	1,611 kg/m
----------------------------------------	---	-------------------	------------



**Büyük Düz Kasa Profil**  
Big Flat Case Profile

Paket İçi Adet Quantity Per Package	3	Gramajı Weight	1,570 kg/m
----------------------------------------	---	-------------------	------------

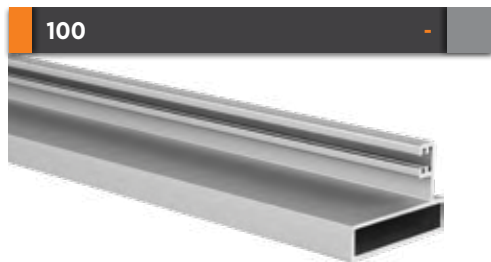

**Dar Yan Dikme Profil**  
Thin Side Column Profile

Paket İçi Adet Quantity Per Package	6	Gramajı Weight	0,441 kg/m
----------------------------------------	---	-------------------	------------



**Geniş Yan Dikme Profil**  
Thick Side Column Profile

Paket İçi Adet Quantity Per Package	6	Gramajı Weight	0,457 kg/m
----------------------------------------	---	-------------------	------------



**Stor Profil**  
Stor Profile

Paket İçi Adet Quantity Per Package	3	Gramajı Weight	1,062 kg/m
----------------------------------------	---	-------------------	------------



**8 mm İspanyolet Profil**  
8 mm Espagnolette Profile

Paket İçi Adet Quantity Per Package	4	Gramajı Weight	0,517 kg/m
----------------------------------------	---	-------------------	------------



**8 mm İspanyolet Profil Karşılığı**  
8 mm Espagnolette Combination Profile

Paket İçi Adet Quantity Per Package	8	Gramajı Weight	0,343 kg/m
----------------------------------------	---	-------------------	------------



# 8mm CAM BALKON FITİL PROFİLLERİ

8mm Balcony Wick Profiles



**Büyük D Fitol**  
Big D Wick

Paket İçi Adet Quantity Per Package	10	Gramajı Weight	0,247 kg/m
----------------------------------------	----	-------------------	------------



**Küçük D Fitol**  
Small D Wick

Paket İçi Adet Quantity Per Package	10	Gramajı Weight	0,167 kg/m
----------------------------------------	----	-------------------	------------



**Küçük h Fitol**  
Small h Wick

Paket İçi Adet Quantity Per Package	20	Gramajı Weight	0,116 kg/m
----------------------------------------	----	-------------------	------------

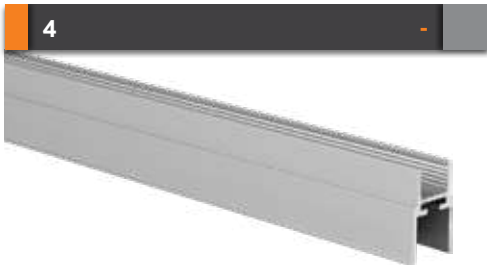

**Orta H Fitol**  
Medium H Wick

Paket İçi Adet Quantity Per Package	10	Gramajı Weight	0,150 kg/m
----------------------------------------	----	-------------------	------------



**Büyük H Fitol**  
Big H Wick

Paket İçi Adet Quantity Per Package	20	Gramajı Weight	0,214 kg/m
----------------------------------------	----	-------------------	------------

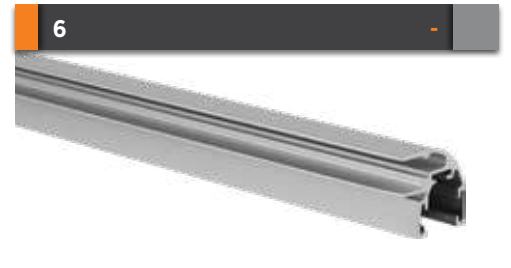

**Köşe Dönüş Fitol**  
Corner Return Wick

Paket İçi Adet Quantity Per Package	10	Gramajı Weight	0,276 kg/m
----------------------------------------	----	-------------------	------------



## Alüminyum Renk Seçeneği

Aluminum Color Options

9016

Beyaz  
White

E6

Mat Eloksal  
Matt Anodized

M0

Mat Bronz  
Matt Bronze

P0

Parlak Bronz  
Gloss Bronze

8003

Altın Meşe  
Golden Oak

8016

Maun  
Mahogany

7016

Antrasit Gri  
Anthracite Gray

Eloksal Boyalı  
Anodized Painted

Bronz Boyalı  
Bronze Painted

**PRC 01**

Gold Dıştan Geçmeli Sistem



**Düz Baza Kapak Sağ - Sol**  
Flat Base Cover Left - Right

Paket İçi Adet Quantity Per Package	150	Koli İçi Adet Quantity Per Box	1.500
----------------------------------------	-----	-----------------------------------	-------

**PRC 02**

Gold Dıştan Geçmeli Sistem



**Gold Radius Kapak**  
Gold Radius Cover

Paket İçi Adet Quantity Per Package	100	Koli İçi Adet Quantity Per Box	600
----------------------------------------	-----	-----------------------------------	-----

**PRC 05**

Gold Dıştan Geçmeli Sistem



**90° Alt Kapak Sağ - Sol**  
90° Bottom Cover Right-Left

Paket İçi Adet Quantity Per Package	100	Koli İçi Adet Quantity Per Box	400
----------------------------------------	-----	-----------------------------------	-----

**PRC 06**

Gold Dıştan Geçmeli Sistem



**90° Üst Kapak Sağ - Sol**  
90° Top Cover Right-Left

Paket İçi Adet Quantity Per Package	100	Koli İçi Adet Quantity Per Box	400
----------------------------------------	-----	-----------------------------------	-----

**PRC 09**

Gold Dıştan Geçmeli Sistem



**Baza Bitiş Kapak Sağ - Sol**  
Base Side Column Cover Right-Left

Paket İçi Adet Quantity Per Package	100	Koli İçi Adet Quantity Per Box	800
----------------------------------------	-----	-----------------------------------	-----

**PRC 11**

Gold Dıştan Geçmeli Sistem



**22,5° Alt Kapak Sağ - Sol**  
22,5° Bottom Cover Right-Left

Paket İçi Adet Quantity Per Package	100	Koli İçi Adet Quantity Per Box	800
----------------------------------------	-----	-----------------------------------	-----

**PRC 12**

Gold Dıştan Geçmeli Sistem



**22,5° Üst Kapak Sağ - Sol**  
22,5° Top Cover Right-Left

Paket İçi Adet Quantity Per Package	100	Koli İçi Adet Quantity Per Box	800
----------------------------------------	-----	-----------------------------------	-----

**PRC 01-PİM**

Gold Pimli Sistem



**Düz Baza Kapak Pimli Sağ-Sol**  
Base Intermediate Cover Flat with Pin Right-Left

Paket İçi Adet Quantity Per Package	150	Koli İçi Adet Quantity Per Box	1.500
----------------------------------------	-----	-----------------------------------	-------

**PRC 05-PİM**

Gold Pimli Sistem



**90° Alt Kapak Pimli Sağ - Sol**  
90° Bottom Cover with Pin Right-Left

Paket İçi Adet Quantity Per Package	100	Koli İçi Adet Quantity Per Box	400
----------------------------------------	-----	-----------------------------------	-----

**PRC 06-PİM**

Gold Pimli Sistem



**90° Üst Kapak Pimli Sağ - Sol**  
90° Top Cover with Pin Right-Left

Paket İçi Adet Quantity Per Package	100	Koli İçi Adet Quantity Per Box	400
----------------------------------------	-----	-----------------------------------	-----

**PRC 09-PİM**

Gold Pimli Sistem



**Baza Bitiş Kapak Pimli Sağ - Sol**  
Base Side Column Cover with Pin Right-Left

Paket İçi Adet Quantity Per Package	100	Koli İçi Adet Quantity Per Box	800
----------------------------------------	-----	-----------------------------------	-----

**PRC 11-PİM**

Gold Pimli Sistem



**22,5° Alt Kapak Pimli Sağ - Sol**  
22,5° Bottom Cover with Pin Right-Left

Paket İçi Adet Quantity Per Package	100	Koli İçi Adet Quantity Per Box	800
----------------------------------------	-----	-----------------------------------	-----

# 8mm CAM BALKON AKSESUARLARI

8mm Balcony Glass Accessories

Renk Seçeneği  
Color Options

Siyah  
Black

**process**  
ALUMINIUM & PVC SYSTEMS

PRC 12-PİM

Gold Pimli Sistem



22,5° Üst Kapak Pimli Sağ - Sol  
22,5° Top Cover with Pin Right-Left

Paket İçi Adet Quantity Per Package	100	Koli İçi Adet Quantity Per Box	800
----------------------------------------	-----	-----------------------------------	-----

PRC 44

Fırtına Sistem



Fırtına Düz Baza Kapak Sağ - Sol  
Fırtına Base Intermediate Cover Flat Right-Left

Paket İçi Adet Quantity Per Package	150	Koli İçi Adet Quantity Per Box	1.500
----------------------------------------	-----	-----------------------------------	-------

PRC 46

Fırtına Sistem



Fırtına 90° Alt Kapak Sağ - Sol  
Fırtına 90° Bottom Cover Right-Left

Paket İçi Adet Quantity Per Package	100	Koli İçi Adet Quantity Per Box	400
----------------------------------------	-----	-----------------------------------	-----

PRC 47

Fırtına Sistem



Fırtına 90° Üst Kapak Sağ - Sol  
Fırtına 90° Top Cover Right-Left

Paket İçi Adet Quantity Per Package	100	Koli İçi Adet Quantity Per Box	400
----------------------------------------	-----	-----------------------------------	-----

PRC 48

Fırtına Sistem



Fırtına Baza Bitiş Kapak Sağ - Sol  
Fırtına Base Side Column Cover Right-Left

Paket İçi Adet Quantity Per Package	100	Koli İçi Adet Quantity Per Box	800
----------------------------------------	-----	-----------------------------------	-----

PRC 50

Fırtına Sistem



Fırtına 22,5° Alt Kapak Sağ - Sol  
Fırtına 22,5° Bottom Cover Right-Left

Paket İçi Adet Quantity Per Package	100	Koli İçi Adet Quantity Per Box	800
----------------------------------------	-----	-----------------------------------	-----

PRC 51

Fırtına Sistem



Fırtına 22,5° Üst Kapak Sağ - Sol  
Fırtına 22,5° Top Cover Right-Left

Paket İçi Adet Quantity Per Package	100	Koli İçi Adet Quantity Per Box	800
----------------------------------------	-----	-----------------------------------	-----

PRC 14



Kilitli Metal Teker  
Locking Wheel with Stainless Pin (Metal)

Paket İçi Adet Quantity Per Package	250	Koli İçi Adet Quantity Per Box	250
----------------------------------------	-----	-----------------------------------	-----

PRC 13



Düz Metal Teker  
Simple Wheel with Stainless Pin (Metal)

Paket İçi Adet Quantity Per Package	250	Koli İçi Adet Quantity Per Box	250
----------------------------------------	-----	-----------------------------------	-----

PRC 82



8 mm İspanyolet Karşılık Aksesuarı  
8 mm Espagnolette Return Accessory

Paket İçi Adet Quantity Per Package	250	Koli İçi Adet Quantity Per Box	1.000
----------------------------------------	-----	-----------------------------------	-------

PRC 32



Plastik Zincir  
Plastic Bead Rope

Paket İçi Adet Quantity Per Package	200 m	Koli İçi Adet Quantity Per Box	2.400 m
----------------------------------------	-------	-----------------------------------	---------

PRC 33



Plastik Zincir Tutamağı  
Plastic Bead Rope Handle

Paket İçi Adet Quantity Per Package	700	Koli İçi Adet Quantity Per Box	700
----------------------------------------	-----	-----------------------------------	-----

PRC 17



**Yönlendirici Boynuz**  
Router

Paket İçi Adet Quantity Per Package	50	Koli İçi Adet Quantity Per Box	300
----------------------------------------	----	-----------------------------------	-----

PRC 18



**Kilit**  
Lock

Paket İçi Adet Quantity Per Package	100	Koli İçi Adet Quantity Per Box	700
----------------------------------------	-----	-----------------------------------	-----

PRC 26



**Borulu Stoplama**  
Stopper

Paket İçi Adet Quantity Per Package	150	Koli İçi Adet Quantity Per Box	150
----------------------------------------	-----	-----------------------------------	-----

PRC 22



**Polyemit Lama 4'lü**  
Guide and Brake for System (4)

Paket İçi Adet Quantity Per Package	200	Koli İçi Adet Quantity Per Box	200
----------------------------------------	-----	-----------------------------------	-----

PRC 23



**Polyemit Lama 7'li**  
Guide and Brake for System (7)

Paket İçi Adet Quantity Per Package	200	Koli İçi Adet Quantity Per Box	200
----------------------------------------	-----	-----------------------------------	-----

PRC 24



**Polyemit Lama 10'lü**  
Guide and Brake for System (10)

Paket İçi Adet Quantity Per Package	100	Koli İçi Adet Quantity Per Box	100
----------------------------------------	-----	-----------------------------------	-----

PRC 20



**Teker Çıkış Plastiği U**  
Outlet Plastics U

Paket İçi Adet Quantity Per Package	100	Koli İçi Adet Quantity Per Box	800
----------------------------------------	-----	-----------------------------------	-----

PRC 79



**U Çıkış Plastik Kapağı**  
Outlet Plastic Cover U

Paket İçi Adet Quantity Per Package	500	Koli İçi Adet Quantity Per Box	500
----------------------------------------	-----	-----------------------------------	-----

PRC 21



**Polyemit Lama Tekli**  
Guide and Brake for System

Paket İçi Adet Quantity Per Package	300	Koli İçi Adet Quantity Per Box	300
----------------------------------------	-----	-----------------------------------	-----

PRC 25



**İnce Yan Dikme Aparatı**  
Thin Side Column Equipment Sys.

Paket İçi Adet Quantity Per Package	150	Koli İçi Adet Quantity Per Box	1.500
----------------------------------------	-----	-----------------------------------	-------

PRC 52



**Kalın Yan Dikme Aparatı**  
Thick Side Column Equipment Sys.

Paket İçi Adet Quantity Per Package	100	Koli İçi Adet Quantity Per Box	600
----------------------------------------	-----	-----------------------------------	-----

PRC 77



**Geniş Yan Dikme Aparatı**  
Wide Side Column Equipment Sys.

Paket İçi Adet Quantity Per Package	100	Koli İçi Adet Quantity Per Box	600
----------------------------------------	-----	-----------------------------------	-----

# 8mm CAM BALKON AKSESUARLARI

8mm Balcony Glass Accessories

PRC 27



**Alüminyum Köşe Dönüş Takımı**

Hinged T-square

Paket İçi Adet Quantity Per Package	200	Koli İçi Adet Quantity Per Box	200
----------------------------------------	-----	-----------------------------------	-----

PRC 30



**Menteşe Takımı Üst**

Hinge Up

Paket İçi Adet Quantity Per Package	200	Koli İçi Adet Quantity Per Box	400
----------------------------------------	-----	-----------------------------------	-----

PRC 31



**Menteşe Takımı Alt**

Hinge Bottom

Paket İçi Adet Quantity Per Package	200	Koli İçi Adet Quantity Per Box	400
----------------------------------------	-----	-----------------------------------	-----

ZZ 126



**İspanyolet Kol**

Espagnolette Handle

Paket İçi Adet Quantity Per Package	1	Koli İçi Adet Quantity Per Box	40
----------------------------------------	---	-----------------------------------	----

ZZ 068

Antrasit Gri  
Anthracite Gray



**Akustik Kol**

Acoustic Handle

Paket İçi Adet Quantity Per Package	1	Koli İçi Adet Quantity Per Box	50
----------------------------------------	---	-----------------------------------	----

PRC 68

Antrasit Gri  
Anthracite Gray



**Eksenel Kol**

Double Glass Axial Handle

Paket İçi Adet Quantity Per Package	1	Koli İçi Adet Quantity Per Box	10
----------------------------------------	---	-----------------------------------	----





**800**

**Baza Profil**  
Double Glass Base

Paket İçi Adet Quantity Per Package	6	Gramajı Weight	0,618 kg/m
----------------------------------------	---	-------------------	------------



**801**

**Düz Kapak Profil**  
Double Glass Flat Cover Profile

Paket İçi Adet Quantity Per Package	6	Gramajı Weight	0,321 kg/m
----------------------------------------	---	-------------------	------------



**802**

**Düz Kapak Mentеше Profil**  
Double Glass Flat Cover with Hinge Profile

Paket İçi Adet Quantity Per Package	6	Gramajı Weight	0,327 kg/m
----------------------------------------	---	-------------------	------------



**803**

**45° Dönüş Profil**  
45° Return Profile

Paket İçi Adet Quantity Per Package	6	Gramajı Weight	0,445 kg/m
----------------------------------------	---	-------------------	------------



**804**

**22,5° Dönüş Profil**  
22,5° Return Profile

Paket İçi Adet Quantity Per Package	6	Gramajı Weight	0,378 kg/m
----------------------------------------	---	-------------------	------------



**805**

**11° Dönüş Profil**  
11° Return Profile

Paket İçi Adet Quantity Per Package	6	Gramajı Weight	0,366 kg/m
----------------------------------------	---	-------------------	------------



**806**

**90° Dönüş Profil**  
90° Return Profile

Paket İçi Adet Quantity Per Package	6	Gramajı Weight	0,475 kg/m
----------------------------------------	---	-------------------	------------



**807**

**Açılı Dönüş Mentеше Profil**  
PopUp Return Hinge Profile

Paket İçi Adet Quantity Per Package	6	Gramajı Weight	0,346 kg/m
----------------------------------------	---	-------------------	------------



**808**

**Isıcam Yan Dikme Profil**  
Double Glass Side Column Profile

Paket İçi Adet Quantity Per Package	6	Gramajı Weight	0,369 kg/m
----------------------------------------	---	-------------------	------------



**809**

**Sabit Cam Mentеше Profil**  
Stable Glass Hinge Profile

Paket İçi Adet Quantity Per Package	6	Gramajı Weight	0,328 kg/m
----------------------------------------	---	-------------------	------------



**810**

**Sabit Cam (Tijli) Kilit Profil**  
Stable Glass Lock Profile

Paket İçi Adet Quantity Per Package	6	Gramajı Weight	0,355 kg/m
----------------------------------------	---	-------------------	------------



**811**

**Sabit Cam (Tijli) Kilit Karşılık Profil**  
Stable Glass Lock Combination Profile

Paket İçi Adet Quantity Per Package	6	Gramajı Weight	0,342 kg/m
----------------------------------------	---	-------------------	------------

# ISICAMLI CAM BALKON PROFİLLERİ

Glazed with Thermopane Glass Balcony Profiles

819



**Düz Kasa Üstten Fitilli Profil**  
Flat Case Top Wicked Profile

Paket İçi Adet Quantity Per Package	3	Gramajı Weight	1,344 kg/m
----------------------------------------	---	-------------------	------------

820



**Oluklu Kasa Üstten Fitilli Profil**  
Corrugated Case Top Wicked Profile

Paket İçi Adet Quantity Per Package	3	Gramajı Weight	1,389 kg/m
----------------------------------------	---	-------------------	------------

822



**Açılır Dikme Profil**  
PopUp Column Profile

Paket İçi Adet Quantity Per Package	6	Gramajı Weight	0,378 kg/m
----------------------------------------	---	-------------------	------------

816



**Üstten Fitilli Büyük Oluklu Kasa**  
Large Corrugated Case with Top Wick

Paket İçi Adet Quantity Per Package	3	Gramajı Weight	1,577 kg/m
----------------------------------------	---	-------------------	------------

817



**Üstten Fitilli Büyük Düz Kasa**  
Large Flat Case with Wed from Top

Paket İçi Adet Quantity Per Package	3	Gramajı Weight	1,532 kg/m
----------------------------------------	---	-------------------	------------

815



**Tij Profil**  
Espagnolette Profile

Paket İçi Adet Quantity Per Package	20	Gramajı Weight	0,100 kg/m
----------------------------------------	----	-------------------	------------

823



**Isıcam Geniş Yan Dikme**  
Double Glass Wide Side Column

Paket İçi Adet Quantity Per Package	6	Gramajı Weight	0,459 kg/m
----------------------------------------	---	-------------------	------------

824



**Sabit Cam İspanyolet Profil**  
Fixed Glass Espagnolette Profile

Paket İçi Adet Quantity Per Package	6	Gramajı Weight	0,583 kg/m
----------------------------------------	---	-------------------	------------

825



**Sabit Cam İspanyolet Karşılık Profil**  
Fixed Glass Espagnolette Handle Provision Profile

Paket İçi Adet Quantity Per Package	6	Gramajı Weight	0,356 kg/m
----------------------------------------	---	-------------------	------------

## Alüminyum Renk Seçeneği

Aluminum Color Options

9016

Beyaz  
White

E6

Mat Eloksal  
Matt Anodized

M0

Mat Bronz  
Matt Bronze

PO

Parlak Bronz  
Gloss Bronze

8003

Altın Meşe  
Golden Oak

8016

Maun  
Mahogany

7016

Antrasit Gri  
Anthracite Gray

Eloksal Boyalı

Anodized Painted

Bronz Boyalı

Bronze Painted

**ZZ 126**

**Siyah**  
Black



**İspanyolet Kol**  
Espagnolette Handle

Paket İçi Adet Quantity Per Package	1	Koli İçi Adet Quantity Per Box	40
----------------------------------------	---	-----------------------------------	----

**ZZ 068**

**Antrasit Gri**  
Anthracite Gray



**Akustik Kol**  
Acoustic Handle

Paket İçi Adet Quantity Per Package	1	Koli İçi Adet Quantity Per Box	50
----------------------------------------	---	-----------------------------------	----

**PRC 68**

**Antrasit Gri**  
Anthracite Gray



**Eksenel Kol**  
Double Glass Axial Handle

Paket İçi Adet Quantity Per Package	1	Koli İçi Adet Quantity Per Box	10
----------------------------------------	---	-----------------------------------	----

**PRC 76**



**Kilit Karşılık (Metal)**  
Double Glass Lock Provision (Metal)

Paket İçi Adet Quantity Per Package	100	Koli İçi Adet Quantity Per Box	400
----------------------------------------	-----	-----------------------------------	-----

**PRC 63**



**Bağlantı Adaptörü**  
Double Glass Connection Adapter

Paket İçi Adet Quantity Per Package	100	Koli İçi Adet Quantity Per Box	1.000
----------------------------------------	-----	-----------------------------------	-------

**PRC 65**



**Destek Takozu**  
Double Glass Bracket Wedge

Paket İçi Adet Quantity Per Package	200	Koli İçi Adet Quantity Per Box	1.000
----------------------------------------	-----	-----------------------------------	-------

**PRC 75**



**Sistem Tij Pimi**  
System Rod Pin

Paket İçi Adet Quantity Per Package	100	Koli İçi Adet Quantity Per Box	200
----------------------------------------	-----	-----------------------------------	-----

**PRC 73**



**Isı Cam EPDM Kauçuk Fitol Çift Conta**  
Double Glass EPDM Rubber Wick Double Gasket

Paket İçi Adet Quantity Per Package	1 Top (10 kg)	Koli İçi Adet Quantity Per Box	≈ 125 m
----------------------------------------	---------------	-----------------------------------	---------

**PRC 74**



**Isı Cam EPDM Kauçuk Fitol Tek Conta**  
Double Glass EPDM Rubber Wick Single Gasket

Paket İçi Adet Quantity Per Package	1 Top (10 kg)	Koli İçi Adet Quantity Per Box	≈ 290 m
----------------------------------------	---------------	-----------------------------------	---------



830



### Fitilli Baza Profil

Wick Base Profile

Paket İçi Adet Quantity Per Package	6	Gramajı Weight	0,680 kg/m
----------------------------------------	---	-------------------	------------

801



### Düz Kapak Profil

Flat Cover Profile

Paket İçi Adet Quantity Per Package	6	Gramajı Weight	0,321 kg/m
----------------------------------------	---	-------------------	------------

802



### Düz Kapak Mentеше Profil

Flat Cover Hinge Profile

Paket İçi Adet Quantity Per Package	6	Gramajı Weight	0,327 kg/m
----------------------------------------	---	-------------------	------------

803



### 45° Dönüş Profil

45 degree Turn Profile

Paket İçi Adet Quantity Per Package	6	Gramajı Weight	0,445 kg/m
----------------------------------------	---	-------------------	------------

804



### 22,5° Dönüş Profil

22,5 degree Turn Profile

Paket İçi Adet Quantity Per Package	6	Gramajı Weight	0,378 kg/m
----------------------------------------	---	-------------------	------------

805



### 11° Dönüş Profil

11 degree Turn Profile

Paket İçi Adet Quantity Per Package	6	Gramajı Weight	0,366 kg/m
----------------------------------------	---	-------------------	------------

806

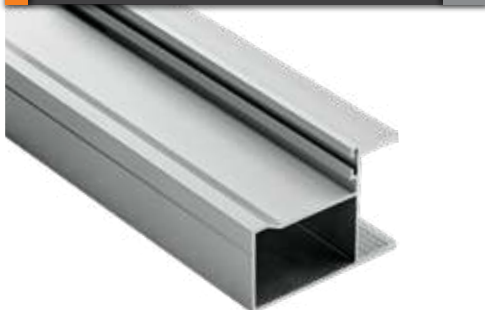

### 90° Dönüş Profil

90 degree Turn Profile

Paket İçi Adet Quantity Per Package	6	Gramajı Weight	0,475 kg/m
----------------------------------------	---	-------------------	------------

807



### Açılı Dönüş Mentеше Profil

Angled Turn Hinge Profile

Paket İçi Adet Quantity Per Package	6	Gramajı Weight	0,346 kg/m
----------------------------------------	---	-------------------	------------

808



### Isıcam Yan Dikme Profil

Double Glass Side Column Profile

Paket İçi Adet Quantity Per Package	6	Gramajı Weight	0,369 kg/m
----------------------------------------	---	-------------------	------------

809



### Sabit Cam Mentеше Profil

Stable Glass Hinge Profile

Paket İçi Adet Quantity Per Package	6	Gramajı Weight	0,328 kg/m
----------------------------------------	---	-------------------	------------

810



### Sabit Cam (Tijli) Kilit Profil

Stable Glass Lock Profile

Paket İçi Adet Quantity Per Package	6	Gramajı Weight	0,355 kg/m
----------------------------------------	---	-------------------	------------

811



### Sabit Cam (Tijli) Kilit Karşılık Profil

Stable Glass Lock Combination Profile

Paket İçi Adet Quantity Per Package	6	Gramajı Weight	0,342 kg/m
----------------------------------------	---	-------------------	------------



**Düz Kasa Profil**  
Flat Case Profile

Paket İçi Adet Quantity Per Package	3	Gramajı Weight	1,355 kg/m
----------------------------------------	---	-------------------	------------



**Oluklu Kasa Profil**  
Corrugated Case Profile

Paket İçi Adet Quantity Per Package	3	Gramajı Weight	1,396 kg/m
----------------------------------------	---	-------------------	------------



**Açılır Dikme Profil**  
Pop-up Column Profile

Paket İçi Adet Quantity Per Package	6	Gramajı Weight	0,378 kg/m
----------------------------------------	---	-------------------	------------



**Oluklu Büyük Kasa Profil**  
Corrugated Big Case Profile

Paket İçi Adet Quantity Per Package	3	Gramajı Weight	1,611 kg/m
----------------------------------------	---	-------------------	------------



**Büyük Düz Kasa Profil**  
Big Flat Case Profile

Paket İçi Adet Quantity Per Package	3	Gramajı Weight	1,570 kg/m
----------------------------------------	---	-------------------	------------



**Isıcam Geniş Yan Dikme**  
Double Glass Wide Side Column

Paket İçi Adet Quantity Per Package	6	Gramajı Weight	0,459 kg/m
----------------------------------------	---	-------------------	------------



**Sabit Cam İspanyolet Profil**  
Fixed Glass Espagnolette Profile

Paket İçi Adet Quantity Per Package	6	Gramajı Weight	0,583 kg/m
----------------------------------------	---	-------------------	------------



**Sabit Cam İspanyolet Karşılık Profil**  
Fixed Glass Espagnolette Handle Profile

Paket İçi Adet Quantity Per Package	6	Gramajı Weight	0,356 kg/m
----------------------------------------	---	-------------------	------------

**Alüminyum Renk Seçeneği**

Aluminum Color Options

9016

Beyaz  
White

E6

Mat Eloksal  
Matt Anodized

M0

Mat Bronz  
Matt Bronze

P0

Parlak Bronz  
Gloss Bronze

8003

Altın Meşe  
Golden Oak

8016

Maun  
Mahogany

7016

Antrasit Gri  
Anthracite Gray

Eloksal Boyalı

Anodized Painted

Bronz Boyalı

Bronze Painted

# Pro+ ISICAMLI CAM BALKON AKSESUARLARI

Pro+ Glazed with Thermopane Glass Balcony Accessories

PRC 100

Siyah  
Black



Pro+ Düz Profil Kapak - 801  
Pro+ Flat Profile Cover - 801

Paket İçi Adet Quantity Per Package	200	Koli İçi Adet Quantity Per Box	1000
----------------------------------------	-----	-----------------------------------	------

PRC 101

Siyah  
Black



Pro+ Düz Mentеше Profil Kapak - 802  
Pro+ Flat Hinge Profile Cover - 802

Paket İçi Adet Quantity Per Package	200	Koli İçi Adet Quantity Per Box	1000
----------------------------------------	-----	-----------------------------------	------

PRC 102

Siyah  
Black



Pro+ 90° Dönüş Profil Kapak Sağ/Sol - 806  
Pro+ 90° Turn Profile Cover Right/Left - 806

Paket İçi Adet Quantity Per Package	100	Koli İçi Adet Quantity Per Box	400
----------------------------------------	-----	-----------------------------------	-----

PRC 103

Siyah  
Black



Pro+ Sabit Cam İspanyolet Kapak Sağ/Sol - 824  
Pro+ Fixed Glass Espagnolette Profile Cover Right/Left - 824

Paket İçi Adet Quantity Per Package	100	Koli İçi Adet Quantity Per Box	400
----------------------------------------	-----	-----------------------------------	-----

PRC 104

Siyah  
Black



Pro+ Sabit Cam İspanyolet Karşılık Kapak Sağ/Sol - 825  
Pro+ Fixed Glass Espagnolette Handle Cover Right/Left - 825

Paket İçi Adet Quantity Per Package	100	Koli İçi Adet Quantity Per Box	400
----------------------------------------	-----	-----------------------------------	-----

PRC 105

Siyah  
Black



Pro+ Açılı Dönüş Profil Kapak Sağ/Sol - 807  
Pro+ Angled Turn Hinge Profile Cover Right/Left - 807

Paket İçi Adet Quantity Per Package	100	Koli İçi Adet Quantity Per Box	400
----------------------------------------	-----	-----------------------------------	-----

PRC 106

Siyah  
Black



Pro+ Sabit Cam Mentеше Profil Kapak Sağ/Sol - 809  
Pro+ Fixed Glass Hinge Profile Cover Right/Left - 809

Paket İçi Adet Quantity Per Package	100	Koli İçi Adet Quantity Per Box	600
----------------------------------------	-----	-----------------------------------	-----

PRC 107

Siyah  
Black



Pro+ Alt Teker U Çıkış Kapak  
Pro+ Bottom Wheel U Exit Cover

Paket İçi Adet Quantity Per Package	100	Koli İçi Adet Quantity Per Box	400
----------------------------------------	-----	-----------------------------------	-----

PRC 108

Siyah  
Black



Pro+ Alt Teker U Çıkış Plastiği  
Pro+ Bottom Wheel U Output Plastic

Paket İçi Adet Quantity Per Package	100	Koli İçi Adet Quantity Per Box	400
----------------------------------------	-----	-----------------------------------	-----

PRC 109

Siyah  
Black



Pro+ Üst Teker U Çıkış Plastiği  
Pro+ Top Wheel U Exit Plastic

Paket İçi Adet Quantity Per Package	100	Koli İçi Adet Quantity Per Box	400
----------------------------------------	-----	-----------------------------------	-----

PRC 110

Siyah  
Black



Pro+ Yönlendirici Boynuz  
Pro+ Router

Paket İçi Adet Quantity Per Package	100	Koli İçi Adet Quantity Per Box	400
----------------------------------------	-----	-----------------------------------	-----

PRC 65

Siyah  
Black



Destek Takozu  
Support Wedge

Paket İçi Adet Quantity Per Package	200	Koli İçi Adet Quantity Per Box	1000
----------------------------------------	-----	-----------------------------------	------

PRC 14



**Kilitli Metal Teker**

Locking Wheel with Stainless Pin (Metal)

Paket İçi Adet  
Quantity Per Package

250

Koli İçi Adet  
Quantity Per Box

250

PRC 13



**Düz Metal Teker**

Simple Wheel with Stainless Pin (Metal)

Paket İçi Adet  
Quantity Per Package

250

Koli İçi Adet  
Quantity Per Box

250

PRC 76



**Kilit Karşılık (Metal)**

Double Glass Lock Apparatus (Metal)

Paket İçi Adet  
Quantity Per Package

100

Koli İçi Adet  
Quantity Per Box

400

PRC 30



**Menteşe Takımı Üst**

Hinge Up

Paket İçi Adet  
Quantity Per Package

200

Koli İçi Adet  
Quantity Per Box

400

PRC 31



**Menteşe Takımı Alt**

Hinge Bottom

Paket İçi Adet  
Quantity Per Package

200

Koli İçi Adet  
Quantity Per Box

400

PRC 21



**Polyemit Lama Tekli**

Guide and Brake for System

Paket İçi Adet  
Quantity Per Package

300

Koli İçi Adet  
Quantity Per Box

300

PRC 22



**Polyemit Lama 4'lü**

Guide and Brake for System (4)

Paket İçi Adet  
Quantity Per Package

200

Koli İçi Adet  
Quantity Per Box

200

PRC 23



**Polyemit Lama 7'li**

Guide and Brake for System (7)

Paket İçi Adet  
Quantity Per Package

200

Koli İçi Adet  
Quantity Per Box

200

PRC 24



**Polyemit Lama 10'lu**

Guide and Brake for System (10)

Paket İçi Adet  
Quantity Per Package

100

Koli İçi Adet  
Quantity Per Box

100

PRC 25



**İnce Yan Dikme Aparatı**

Thin Side Column Equipment Sys.

Paket İçi Adet  
Quantity Per Package

150

Koli İçi Adet  
Quantity Per Box

1.500

PRC 52



**Kalın Yan Dikme Aparatı**

Thick Side Column Equipment Sys.

Paket İçi Adet  
Quantity Per Package

100

Koli İçi Adet  
Quantity Per Box

600

PRC 77



**Geniş Yan Dikme Aparatı**

Wide Side Column Equipment Sys.

Paket İçi Adet  
Quantity Per Package

100

Koli İçi Adet  
Quantity Per Box

600

# Pro+ ISICAMLI CAM BALKON AKSESUARLARI

Pro+ Glazed with Thermopane Glass Balcony Accessories

PRC 26



## Borulu Stoplama

Stopper

Paket İçi Adet Quantity Per Package	150	Koli İçi Adet Quantity Per Box	150
----------------------------------------	-----	-----------------------------------	-----

PRC 73



## Isı Cam EPDM Kauçuk Fitol Çift Conta

Double Glass EPDM Rubber Wick Double Gasket

Paket İçi Adet Quantity Per Package	1 Top (10 kg)	Koli İçi Adet Quantity Per Box	≈125 m
----------------------------------------	---------------	-----------------------------------	--------

PRC 74



## Isı Cam EPDM Kauçuk Fitol Tek Conta

Double Glass EPDM Rubber Wick Single Gasket

Paket İçi Adet Quantity Per Package	1 Top (10 kg)	Koli İçi Adet Quantity Per Box	≈290 m
----------------------------------------	---------------	-----------------------------------	--------

ZZ 126

Siyah  
Black



## İspanyolet Kol

Espagnolette Handle

Paket İçi Adet Quantity Per Package	1	Koli İçi Adet Quantity Per Box	40
----------------------------------------	---	-----------------------------------	----

ZZ 068

Antrasit Gri  
Anthracite Gray



## Akustik Kol

Acoustic Handle

Paket İçi Adet Quantity Per Package	1	Koli İçi Adet Quantity Per Box	50
----------------------------------------	---	-----------------------------------	----



210



**Sürme Baza Profil**  
Sliding Base Profile

Paket İçi Adet Quantity Per Package	5	Gramajı Weight	0,643 kg/m
----------------------------------------	---	-------------------	------------

215



**Çekme Kol Profil**  
Pull Handle Profile

Paket İçi Adet Quantity Per Package	3	Gramajı Weight	0,908 kg/m
----------------------------------------	---	-------------------	------------

212



**Kenet Profil**  
Clamp Profile

Paket İçi Adet Quantity Per Package	6	Gramajı Weight	0,423 kg/m
----------------------------------------	---	-------------------	------------

211



**Birleştirme Karşılık Profil**  
Combination Provisions Profile

Paket İçi Adet Quantity Per Package	6	Gramajı Weight	0,301 kg/m
----------------------------------------	---	-------------------	------------

213



**İkili Eşikli Alt Kasa Profil**  
Double Threshold Lower Case Profile

Paket İçi Adet Quantity Per Package	4	Gramajı Weight	0,974 kg/m
----------------------------------------	---	-------------------	------------

222



**Üçlü Eşikli Alt Kasa Profil**  
Triple Threshold Lower Case Profile

Paket İçi Adet Quantity Per Package	2	Gramajı Weight	1,333 kg/m
----------------------------------------	---	-------------------	------------

220



**Üçlü Eşiksiz Alt Kasa Profil**  
Triple Bottom Case Profile without Threshold

Paket İçi Adet Quantity Per Package	4	Gramajı Weight	0,867 kg/m
----------------------------------------	---	-------------------	------------

229



**İkili Üst Kasa Profil**  
Double Upper Case Profile

Paket İçi Adet Quantity Per Package	2	Gramajı Weight	1,120 kg/m
----------------------------------------	---	-------------------	------------

230



**Üçlü Üst Kasa Profil**  
Triple Upper Case Profile

Paket İçi Adet Quantity Per Package	2	Gramajı Weight	1,552 kg/m
----------------------------------------	---	-------------------	------------

221



**Dörtlü Eşiksiz Alt Kasa Profil**  
Quadruple Bottom Case Profile without Threshold

Paket İçi Adet Quantity Per Package	2	Gramajı Weight	1,156 kg/m
----------------------------------------	---	-------------------	------------

214



**İkili Yan Kasa Profil**  
Double Side Case Profile

Paket İçi Adet Quantity Per Package	4	Gramajı Weight	0,587 kg/m
----------------------------------------	---	-------------------	------------

223



**Üçlü Yan Kasa Profil**  
Triple Side Case Profile

Paket İçi Adet Quantity Per Package	2	Gramajı Weight	0,792 kg/m
----------------------------------------	---	-------------------	------------



**8 mm Cam Adaptörü**  
8 mm Glass Adapter

Paket İçi Adet Quantity Per Package	10	Gramajı Weight	0,219 kg/m
----------------------------------------	----	-------------------	------------



**Kapatma Profil**  
Closing Profile

Paket İçi Adet Quantity Per Package	20	Gramajı Weight	0,071 kg/m
----------------------------------------	----	-------------------	------------



**İspanyolet Çekme Kol Profili**  
Espagnolette Pull Handle Profile

Paket İçi Adet Quantity Per Package	3	Gramajı Weight	0,751 kg/m
----------------------------------------	---	-------------------	------------

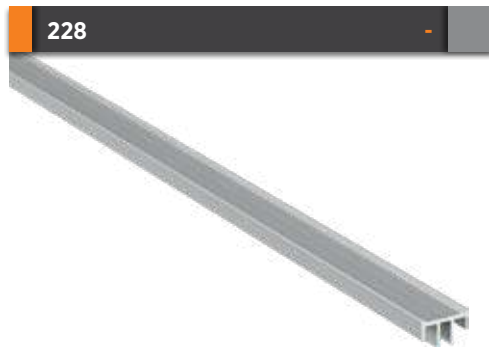

**İspanyolet Karşılık Profili**  
Espagnolette Provision Profile

Paket İçi Adet Quantity Per Package	10	Gramajı Weight	0,156 kg/m
----------------------------------------	----	-------------------	------------

**Alüminyum Renk Seçeneği**

Aluminum Color Options





PSS 1

Siyah  
Black



**Çekme Kol Profil Aksesuarı**  
Sliding Profile Plastic

Paket İçi Adet Quantity Per Package	50	Koli İçi Adet Quantity Per Box	200
----------------------------------------	----	-----------------------------------	-----

PSS 2

Siyah  
Black



**Kenet Profil Aksesuarı - Sağ**  
Tensile Profile Plastic - Right

Paket İçi Adet Quantity Per Package	50	Koli İçi Adet Quantity Per Box	200
----------------------------------------	----	-----------------------------------	-----

PSS 3

Siyah  
Black



**Kenet Profil Aksesuarı - Sol**  
Tensile Profile Plastic - Left

Paket İçi Adet Quantity Per Package	50	Koli İçi Adet Quantity Per Box	200
----------------------------------------	----	-----------------------------------	-----

PSS 4

Siyah  
Black



**İspanyollet Çekme Kol Aksesuarı**  
Espagnolette Pull Handle Accessory

Paket İçi Adet Quantity Per Package	50	Koli İçi Adet Quantity Per Box	200
----------------------------------------	----	-----------------------------------	-----

PSS 5

Siyah  
Black



**İkili Köşe Takoğu**  
Double Corner Wedge

Paket İçi Adet Quantity Per Package	50	Koli İçi Adet Quantity Per Box	200
----------------------------------------	----	-----------------------------------	-----

PSS 6

Siyah  
Black



**Üçlü Köşe Takoğu**  
Triple Corner Wedge

Paket İçi Adet Quantity Per Package	50	Koli İçi Adet Quantity Per Box	200
----------------------------------------	----	-----------------------------------	-----

PSS 7

Siyah  
Black



**Vida Tapası**  
Screw Plug

Koli İçi Adet Quantity Per Box	2.000
-----------------------------------	-------

PSS 12

Siyah  
Black



**Sürme Yalıtım Aksesuarı**  
Sliding Insulation Accessory

Koli İçi Adet Quantity Per Box	200
-----------------------------------	-----

PSS 8



**Paslanmaz Lüks Teker**  
Stainless Luxury Wheel

Koli İçi Adet Quantity Per Box	200
-----------------------------------	-----

PSS 9



**Havuz Kol (Kilitsiz)**  
Hole Handle (Unlocked)

Paket İçi Adet Quantity Per Package	1	Koli İçi Adet Quantity Per Box	1
----------------------------------------	---	-----------------------------------	---

PSS 10



**Klips Kol**  
Clasp Handle

Paket İçi Adet Quantity Per Package	1	Koli İçi Adet Quantity Per Box	1
----------------------------------------	---	-----------------------------------	---

PSS 11



**Kale 201 F (Horoz) Kilit**  
Kale 201 F (Pin) Lock

Paket İçi Adet Quantity Per Package	1	Koli İçi Adet Quantity Per Box	1
----------------------------------------	---	-----------------------------------	---



140

**Sabit Panel Açılır Alt Baza Profil**  
Fixed Panel Pop-up Base Profile

Paket İçi Adet Quantity Per Package	6	Gramajı Weight	0,563 kg/m
----------------------------------------	---	-------------------	------------



164

**Sabit Panel Yan Dikme Profil**  
Fixed Panel Side Column Profile

Paket İçi Adet Quantity Per Package	4	Gramajı Weight	0,842 kg/m
----------------------------------------	---	-------------------	------------



142

**Sabit Panel Üst Baza Profil**  
Fixed Panel Top Base Profile

Paket İçi Adet Quantity Per Package	4	Gramajı Weight	0,750 kg/m
----------------------------------------	---	-------------------	------------



167

**Kenet Baza Profil**  
Clamp Base Profile

Paket İçi Adet Quantity Per Package	4	Gramajı Weight	1,144 kg/m
----------------------------------------	---	-------------------	------------



144

**Hareketli Panel Yan Dikme Profil**  
Movable Panel Side Column Profile

Paket İçi Adet Quantity Per Package	6	Gramajı Weight	0,434 kg/m
----------------------------------------	---	-------------------	------------



145

**Kúpešte Baza Profil**  
Handrail Base Profile

Paket İçi Adet Quantity Per Package	6	Gramajı Weight	0,579 kg/m
----------------------------------------	---	-------------------	------------



146

**Hareketli Panel Açılır Alt Baza Profil**  
Movable Panel Pop-up Lower Base Profile

Paket İçi Adet Quantity Per Package	4	Gramajı Weight	0,741 kg/m
----------------------------------------	---	-------------------	------------



161

**Ray Kapatma "T" Profil**  
Rail Closure "T" Profile

Paket İçi Adet Quantity Per Package	4	Gramajı Weight	0,482 kg/m
----------------------------------------	---	-------------------	------------



160

**Yan Ray "T" Profil**  
Side Rail "T" Profile

Paket İçi Adet Quantity Per Package	2	Gramajı Weight	1,057 kg/m
----------------------------------------	---	-------------------	------------



166

**Açılımlı için Ray Kapatma 'L' Profil**  
Rail Closure 'L' Profile for Opening

Paket İçi Adet Quantity Per Package	10	Gramajı Weight	0,144 kg/m
----------------------------------------	----	-------------------	------------



162

**Yan Ray "L" Profil**  
Side Rail "L" Profile

Paket İçi Adet Quantity Per Package	4	Gramajı Weight	0,703 kg/m
----------------------------------------	---	-------------------	------------



GYT 28

**Et Kalınlığı 1,2 mm**  
wall thickness 1,2 mm

**Sac Tambur Borusu**  
Sheet Drum Pipe

Paket İçi Adet Quantity Per Package	1	Boy Length	7 m
----------------------------------------	---	---------------	-----



**152** -  
**Alt Kasa Profil**  
Lower Case Profile

Paket İçi Adet Quantity Per Package	2	Gramajı Weight	1,563 kg/m
----------------------------------------	---	-------------------	------------



**156** -  
**Üst Kasa Profil**  
Top Case Profile

Paket İçi Adet Quantity Per Package	1	Gramajı Weight	3,449 kg/m
----------------------------------------	---	-------------------	------------



**153** -  
**Üst Kasa Kapak Profil**  
Top Case Cover Profile

Paket İçi Adet Quantity Per Package	2	Gramajı Weight	0,864 kg/m
----------------------------------------	---	-------------------	------------



**155** -  
**Yan Kasa Profil**  
Side Case Profile

Paket İçi Adet Quantity Per Package	2	Gramajı Weight	1,669 kg/m
----------------------------------------	---	-------------------	------------



**154** -  
**Küpeşte Profil**  
Handrail Profile

Paket İçi Adet Quantity Per Package	2	Gramajı Weight	0,759 kg/m
----------------------------------------	---	-------------------	------------



**165** -  
**Yan Kasa Kertme Profil**  
Side Case Notched Profile

Paket İçi Adet Quantity Per Package	4	Gramajı Weight	0,644 kg/m
----------------------------------------	---	-------------------	------------



**158** -  
**Açılımsız Tek Fıtıl Yan Ray L Kasa Profil**  
Single Weatherstrips Without Opening Side L Case Profile

Paket İçi Adet Quantity Per Package	4	Gramajı Weight	0,510 kg/m
----------------------------------------	---	-------------------	------------



**159** -  
**Açılımsız Çift Fıtıl Yan Ray L Kasa Profil**  
Double Weatherstrips Without Opening Side L Case Profile

Paket İçi Adet Quantity Per Package	4	Gramajı Weight	0,660 kg/m
----------------------------------------	---	-------------------	------------



**219** **Tek Cam Adaptörü/ Single Glass Adapter**

Paket İçi Adet Quantity Per Package	10	Gramajı Weight	0,219 kg/m
----------------------------------------	----	-------------------	------------



**149** -  
**Açılımsız için Ray Kapatma 'L' Profil**  
Rail Closure 'L' Profile for Non-Opening

Paket İçi Adet Quantity Per Package	10	Gramajı Weight	0,162 kg/m
----------------------------------------	----	-------------------	------------

### Alüminyum Renk Seçeneği

Aluminum Color Options



9016  
Beyaz  
White



E6  
Mat Eloksal  
Matt Anodized



MO  
Mat Bronz  
Matt Bronze



8003  
Altın Meşe  
Golden Oak



8016  
Maun  
Mahogany



7016  
Antrasit Gri  
Anthracite Gray



9005  
Siyah  
Black

GYT 1

Siyah  
Black



**Küpeste Baza Profil Aksesuarı**  
Handrail Base Profile Accessories

Koli İçi Adet  
Quantity Per Box 100

GYT 2

Siyah  
Black



**Sabit Panel Aksesuar - Alt**  
Fixed Panel Accessory - Bottom

Koli İçi Adet  
Quantity Per Box 100

GYT 3 A

Siyah  
Black



**Kenet Kapak Profil - Sağ / Sol - 146**  
Clamp Profile Plastics - Right / Left - 146

Koli İçi Adet  
Quantity Per Box 200

GYT 3 B

Siyah  
Black



**Kenet Kapak Profil - Sağ / Sol - 167**  
Clamp Profile Plastics - Right / Left - 167

Koli İçi Adet  
Quantity Per Box 400

GYT 4



**Oluklu Köşe Takozu**  
Corrugated Corner Wedge

Koli İçi Adet  
Quantity Per Box 50

GYT 5



**Köşe Takozu**  
Corner Wedge

Koli İçi Adet  
Quantity Per Box 100

GYT 6

Siyah  
Black



**Üst Kasa Rulmanlı Kapak**  
Top Case Bearing Cover

Koli İçi Adet  
Quantity Per Box 20

GYT 7

Siyah  
Black



**Üst Kasa Motor Bağlantı Kapak**  
Top Case Engine Connection Cover

Koli İçi Adet  
Quantity Per Box 20

GYT 8

Siyah  
Black



**Yan Kasa Köşe Birleştirme Takozu**  
Side Case Corner Joint Plastic

Koli İçi Adet  
Quantity Per Box 100

GYT 9

Siyah  
Black



**Küpeste Kapağı - Sağ / Sol**  
Handrail Cover - Right / Left

Koli İçi Adet  
Quantity Per Box 200

GYT 10

Siyah  
Black



**Zincir Kapama Aksesuar Sağ/Sol**  
Chain Cover Accessory - Right / Left

Koli İçi Adet  
Quantity Per Box 200

GYT 11

Siyah  
Black



**Çift Açılır Sabit Panel Aksesuar Üst - Sağ/Sol**  
Double Open Fixed Panel Accessory Top - Right/Left

Koli İçi Adet  
Quantity Per Box 200

GYT 27

Siyah  
Black



Açılımsız Sabit Panel Aksesuar - Alt  
Fixed Panel Accessory without Opening - Bottom

Koli İçi Adet  
Quantity Per Box 100

GYT 12



Özel Cephe Makası  
Special Facade Scissors

Koli İçi Adet  
Quantity Per Box 6 Set/Sets

GYT 13

Siyah  
Black



Orta Panel Çeliği  
Center Panel Steel

Koli İçi Adet  
Quantity Per Box 40

GYT 14

Siyah  
Black



Kilit Takımı  
Lock Set

Koli İçi Adet  
Quantity Per Box 100

GYT 15

Siyah  
Black



Zincir Bağlantı Elemanı  
Chain Connector

Koli İçi Adet  
Quantity Per Box 40

GYT 16



Tekerli Bağlantı Elemanı  
Wheel Connector

Koli İçi Adet  
Quantity Per Box 80

GYT 17

Siyah  
Black



Panel Hizalama - Sağ/Sol  
Panel Aligning - Right/Left

Koli İçi Adet  
Quantity Per Box 100

GYT 19



Tambur Bağlantı Elemanı  
Drum Connector

Koli İçi Adet  
Quantity Per Box 20

GYT 20



Zincir Dişli  
Sprocket

Koli İçi Adet  
Quantity Per Box 20

GYT 18

Siyah  
Black



Zincir Yönlendirici  
Chain Router

Koli İçi Adet  
Quantity Per Box 100

GYT 21



Zincir  
Chain

Koli İçi Adet  
Quantity Per Box 1 (5 m)

GYT 25



Zincir Ağırlık  
Chain Weight

Koli İçi Adet  
Quantity Per Box 16



**Sabit Panel Sızdırmazlık Contası**  
Fixed Panel Sealing Gasket

Koli İçi Adet  
Quantity Per Box 200 m



**Üst Kasa Balon Conta**  
Top Case Balloon Gasket

Koli İçi Adet  
Quantity Per Box 100 m



**Sabit Panel Yaprak Conta**  
Fixed Panel Leaf Gasket

Koli İçi Adet  
Quantity Per Box 100 m



**Giyotin Motor (120Nm)**  
Guillotine Engine (120Nm)

Koli İçi Adet  
Quantity Per Box 1



**Motor Kumandası (tekli)**  
Engine Remote Control (mono)

Koli İçi Adet  
Quantity Per Box 1



**Motor Kumandası (çoklu)**  
Engine Remote Control (multi)

Koli İçi Adet  
Quantity Per Box 1



**Giyotin Motor (120Nm)**  
Guillotine Engine (120Nm)

Koli İçi Adet  
Quantity Per Box 1



**Motor Kumandası (tekli)**  
Engine Remote Control (mono)

Koli İçi Adet  
Quantity Per Box 1



**Motor Kumandası (çoklu)**  
Engine Remote Control (multi)

Koli İçi Adet  
Quantity Per Box 1



417



**Sonlandırıcı Cam Çıta Kapak Profili**  
End Cap Glass Strip Cover Profile

Paket İçi Adet Quantity Per Package	4	Gramajı Weight	0,467 kg/m
----------------------------------------	---	-------------------	------------

418



**Cam Çıta Kapak Profili**  
Glass Strip Cover Profile

Paket İçi Adet Quantity Per Package	10	Gramajı Weight	0,329 kg/m
----------------------------------------	----	-------------------	------------

419



**Orta Kayıt Profili**  
Center Mullion Profile

Paket İçi Adet Quantity Per Package	2	Gramajı Weight	2,100 kg/m
----------------------------------------	---	-------------------	------------

420

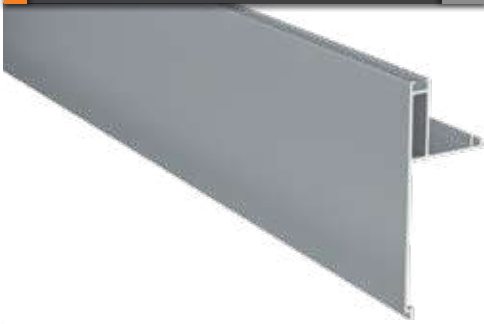

**Kasa Kapatma Profili**  
Frame Closure Profile

Paket İçi Adet Quantity Per Package	2	Gramajı Weight	0,682 kg/m
----------------------------------------	---	-------------------	------------

421

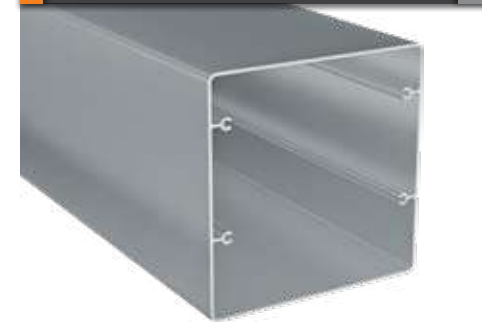

**Ayak Profili**  
Leg Profile

Paket İçi Adet Quantity Per Package	1	Gramajı Weight	3,184 kg/m
----------------------------------------	---	-------------------	------------

422



**Oluk Profili**  
Groove Profile

Paket İçi Adet Quantity Per Package	1	Gramajı Weight	4,318 kg/m
----------------------------------------	---	-------------------	------------

423



**Destekli Orta Kayıt Profili**  
Reinforced Center Mullion Profile

Paket İçi Adet Quantity Per Package	2	Gramajı Weight	3,142 kg/m
----------------------------------------	---	-------------------	------------

424



**Duvar Kasa Profili**  
Wall Frame Profile

Paket İçi Adet Quantity Per Package	1	Gramajı Weight	2,835 kg/m
----------------------------------------	---	-------------------	------------

426



**Gizli Ayak Profili**  
Hidden Leg Profile

Paket İçi Adet Quantity Per Package	1	Gramajı Weight	3,434 kg/m
----------------------------------------	---	-------------------	------------

427



**Destek Kutu Profili**  
Reinforcing Box Profile

Paket İçi Adet Quantity Per Package	2	Gramajı Weight	2,271 kg/m
----------------------------------------	---	-------------------	------------

428



**Gizli Ayak ve Destek Kutu Kapatma Profili**  
Hidden Leg Case Cover Support Profile

Paket İçi Adet Quantity Per Package	10	Gramajı Weight	0,501 kg/m
----------------------------------------	----	-------------------	------------

429



**Cam Çıtası Profili**  
Glass Strip Profile

Paket İçi Adet Quantity Per Package	2	Gramajı Weight	0,578 kg/m
----------------------------------------	---	-------------------	------------



## CAM TAVAN PROFİLLERİ

Glass Ceiling Profiles

430



**Ledli Orta Kayıt Profili**  
Center Mullion Profile with Led

Paket İçi Adet Quantity Per Package	2	Gramajı Weight	2,252 kg/m
----------------------------------------	---	-------------------	------------

431

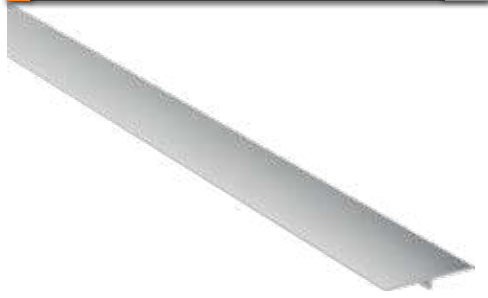

**T Profili**  
T Profile

Paket İçi Adet Quantity Per Package	10	Gramajı Weight	0,079 kg/m
----------------------------------------	----	-------------------	------------

## CAM TAVAN AKSESUARLARI

Glass Ceiling Accessories

⊕ İşaretili ürünler proje profil renklerine göre sipariş edilebilir.  
⊕ Marked products can be ordered according to project-specific profile colors.

CT 01

Siyah  
Black



**Orta Kayıt Plastik Kapak**  
Middle Mullion Plastic Cover

Koli İçi Adet Quantity Per Box	60
-----------------------------------	----

CT 02

⊕ Renk seçenekleri mevcuttur  
⊕ Color options are available



**Ayak Profili Sabitleme Aksesuarı**  
Leg Profile Fixing Accessory

Koli İçi Adet Quantity Per Box	20
-----------------------------------	----

CT 03

⊕ Renk seçenekleri mevcuttur  
⊕ Color options are available



**Metal Oluk Kasa Kapak - Sağ/Sol**  
Metal Gutter Box Cover - Right/Left

Koli İçi Adet Quantity Per Box	20
-----------------------------------	----

CT 04

⊕ Renk seçenekleri mevcuttur  
⊕ Color options are available



**Metal Duvar Kasa Kapak - Sağ/Sol**  
Metal Wall Casing Cover - Right/Left

Koli İçi Adet Quantity Per Box	20
-----------------------------------	----

CT 05



**Oluklu Kasa Bağlantı Aksesuarı**  
Corrugated Box Connection Accessory

Koli İçi Adet Quantity Per Box	100
-----------------------------------	-----

CT 06



**Duvar Kasa Bağlantı Aksesuarı**  
Wall Casing Connection Accessory

Koli İçi Adet Quantity Per Box	100
-----------------------------------	-----



**Orta Kayıt Contası**  
Middle Mullion Gasket

Koli İçi Adet  
Amount within parcel 200 mt



**Cam Çıta Contası**  
Glass Strip Gasket

Koli İçi Adet  
Amount within parcel 140 mt



**Oluk Kasa Yalıtım Yaprak Contası**  
Gutter Box Insulation Leaf Gasket

Koli İçi Adet  
Quantity Per Box 85 mt



**Duvar Kasa Yalıtım Yaprak Contası**  
Wall Casing Insulation Leaf Gasket

Koli İçi Adet  
Quantity Per Box 55 mt



**Gizli Ayak Profili Sabitleme Aksesuarı**  
Hidden Leg Profile Fixing Accessory

Koli İçi Adet  
Quantity Per Box 20



**Destek Kutu Sabitleme Aksesuarı**  
Reinforcing Box Fixing Accessory

Koli İçi Adet  
Quantity Per Box 40



**Filtre Kapağı**  
Filter Cover

Koli İçi Adet  
Quantity Per Box 20



**Contalı Pul**  
Gasket Flake

Koli İçi Adet  
Quantity Per Box 200



**Plastik Led Kapak Profil**  
Plastic Led Cover Profile

Koli İçi Adet  
Quantity Per Box 6 m

## Plise Perde

Perdecilik sektörünün teknolojik gelişmelere paralel olarak sürekli bir ilerleme göstermesinin sonucunda tüm mekanlarda kullanılabilecek yeni nesil perde sistemleri geliştirerek müşterilerimizin konforunu sağlamayı hedefliyoruz. Klasik perde kumaşlarından farklı olarak güneş ışınlarını filtrelemek, mekanlarda ısı dengesini sağlamak gibi işlevleri olan teknik kumaşlardan yapılan modern perde modellerinin kullanımı giderek daha yaygın hale geliyor. İple kontrol edilenlerinin yanında motorlu alternatifleri de olan plise perde modelleri özellikle modern tarzda dekore edilmiş mekanlara çok iyi uyum sağlıyor.

## Özellikleri

Plise perde sistemlerinin katlanır cam balkonlar, geometrik pencereler PVC pencere ve kapılar için çözüm odaklı olduğunu söylesek yanlış olmayız. Aynı zaman da sürekli olarak ulaşılması zor noktalar için de başarılı çözümler geliştirmiştir. Yarı geçirgen yapısı sayesinde aydınlık ortamlar yaratır.

Katlanır cam balkon sistemlerinde, PVC pencere ve kapılarda, Winter Garden (Kış Bahçesi) Sistemlerde, yat, tekne, tavan perdeleri, çatı perdesi, eğimli ve geometrik pencereler vs. uygulamalarda kullanılmaktadır. Motorlu ve kumandalı sistemlerinde çok rahatlıkla uygulandığı modeller arasındadır.

Yıkılabilen, silinebilen özelliği ile plise perde sistemleri kolay kullanım sağlar. Aynı zaman da alev almama özelliği ile de sağlıklı ortamlar yaratır.

## Pleat Curtain

In parallel with the technological developments of the curtain-making industry, We aim to improve the comfort of our customers by developing new-generation curtain systems and to provide the best possible service. Unlike classic curtain fabrics, modern curtain models made of technical fabrics have functions such as filtering sunlight and providing heat balance in spaces, becoming more widespread. Especially in areas decorated in a modern style, motorized pleated blinds are a good alternative to rope-controlled pleated blinds.

## Properties

Pleated curtain systems are a beautiful solution for folding glass balconies, geometric windows, PVC windows, and doors. It has also developed successful solutions that can be used for hard-to-reach spots. Thanks to its semi-permeable structure creates bright environments.

Folding glass balcony systems, PVC windows, and doors, Winter Garden (Winter Garden) Systems, yacht, boat, ceiling curtains, roof curtains, curved and geometric windows, etc. applications are being used.

Pleat curtain systems with washable and wipeable features provides easy use. At the same time, with its non-flammable feature creates healthy and safe environments.



## Plise Perde Nedir?

Katlanır cam balkon sistemleri ve PVC Kapı, pencereler için sıklıkla tercih edilen, ipli mekanizmasıyla aşağı-yukarı yönlü hareket imkanı sağlayan, mekanda gün ışığının yumuşak bir şekilde dağılımını sağlayan bir perde türüdür. Özellikle çatı katları, gemiler, kış bahçeleri, katlanır cam balkon sistemleri gibi mekanların çok köşeli, eğimli, bazen ulaşılması zor olan pencereleri için kullanılmaya uygundur. Görünümü dekoratif, kullanımı pratiktir. Belli bir boyuta kadar tek parça olarak uygulanabildiği gibi ayrı cam kanatlara uygun ebattaki parçalar halinde monte edilerek uygulanabilmektedir.



## Mekanlarda Sade ve Modern Bir Görünüm

Plise perdelerin görünümü sade ve detaysızdır, bu yüzden hemen her ortama uyum sağlarlar. Biraz modern - biraz klasik veya daha gösterişli bir görünüm istediğiniz mekanlar için plise perdeyi kumaş perdelerle kombinleyerek de kullanabilirsiniz.

## A Simple and Modern Appearance in Spaces

The appearance of pleated curtains is plain and without details, so immediately they adapt to any environment. A little modern - a little classic or more Pleat curtain for places where you want a flashy look. You can also use it in combination with fabric curtains.



## İple Kontrol Etmek Tek Seçenek Değil

Plise perdenizi mekanizmasındaki ip sistemi yardımıyla kontrol edebilir veya motorlu olarak üretilmesini tercih edebilirsiniz.

## Rope Control Is Not The Only Option

You can use your pleated curtain with the help of the rope system or you can choose to have a motorized system.

Modern bir dizaynı olan bu fonksiyonel perde türü tasarım ilkelerinin bir avantajı olarak mekanlarda enerji sarfiyatının azaltılmasına yardımcı olur. Güçlü ve kullanışlı bir perde türüdür. Katlanmış hali çok az yer kapladığı için görüntü kirliliğine yol açmaz. 3 metre uzunluğundaki bir tepe penceresine uygulanması durumunda, toplandığında kapladığı yer 10 cm civarındadır. Farklı renk seçenekleri mevcuttur. Esnek yapısı sayesinde dar bölgelerde, asimetrik formlu, üçgen veya dairesel pencerelerde, tavanlarda kullanılabilir. Pencere kanatlarıyla tavan arasındaki mesafenin az olması durumunda da uygulanabilir. Mekanları sıcak günlerde fazla ısınmaktan korur, istenilen ölçüde mahremiyet sağlar. Tavan camları veya cam balkon için perdeye ihtiyacınız varsa plise perde sizin için en iyi seçim olacaktır.

## What is Pleat Curtain?

It is a type of curtain that is frequently preferred in folding glass balcony systems and PVC doors and windows and provides soft light to spaces with its up-down movement with a rope mechanism. It is suitable for use on windows which have very angular, curved, that are difficult to reach especially such as spaces folding glass balcony systems in attics, ships, winter gardens. It has a decorative appearance and is practical to use. It can be applied in one piece up to a certain size or in pieces of suitable size for separate glass wings. It is a functional curtain type with a modern design, consisting of a combination of design principles. It has an advantage that helps reduce energy consumption in spaces.

It is a strong and useful type of curtain. It takes very little space when folded therefore does not cause visual pollution. If a 3-meter long curtain applied to the skylight, when its folded the space occupied around 10 cm. Different color options are available. Thanks to its flexible structure, it can be applied to asymmetric, triangular or circular shape windows at ceilings or narrow areas. It can also be applied if the distance between ceiling with window sashes is small. It protects spaces from overheating on hot days, and provides required privacy. If you need curtains for ceiling glazing or a glass balcony, pleated curtain will be the best choice for you.



**T Profil Kapak (Pimli)**  
Pinned T Profile Cover

Paket İçi Adet Quantity Per Package	1.000	Koli İçi Adet Quantity Per Box	1.000
----------------------------------------	-------	-----------------------------------	-------



**Small T Profil Kapak**  
Small T Profile Cover

Paket İçi Adet Quantity Per Package	1.000	Koli İçi Adet Quantity Per Box	2.000
----------------------------------------	-------	-----------------------------------	-------



**Çiftli Orta Profil Kapak**  
Double Middle Profile Cover

Paket İçi Adet Quantity Per Package	500	Koli İçi Adet Quantity Per Box	500
----------------------------------------	-----	-----------------------------------	-----



**20'lik T Profil Kapak**  
20 T Profile Cover

Paket İçi Adet Quantity Per Package	500	Koli İçi Adet Quantity Per Box	1.000
----------------------------------------	-----	-----------------------------------	-------



**Yaylı Yapışkan Profil Kapak**  
Spring Adhesive Profile Cover

Paket İçi Adet Quantity Per Package	500	Koli İçi Adet Quantity Per Box	1.000
----------------------------------------	-----	-----------------------------------	-------



**Yaylı Portray Profil Kapak**  
Spring Portray Profile Cover

Paket İçi Adet Quantity Per Package	1.000	Koli İçi Adet Quantity Per Box	1.000
----------------------------------------	-------	-----------------------------------	-------



**Etekli T Profil Kapak (Pimli)**  
Pinned Skirted T Profile Cover

Paket İçi Adet Quantity Per Package	1.000	Koli İçi Adet Quantity Per Box	1.000
----------------------------------------	-------	-----------------------------------	-------



**Kilit Takımı (Çıtçıtılı)**  
Lock Set (with snap fastener)

Paket İçi Adet Quantity Per Package	1.000	Koli İçi Adet Quantity Per Box	2.000
----------------------------------------	-------	-----------------------------------	-------



**Kilit Takımı (Alyanlı)**  
Lock Set (with hex key)

Paket İçi Adet Quantity Per Package	1.000	Koli İçi Adet Quantity Per Box	2.000
----------------------------------------	-------	-----------------------------------	-------



**Çiftli Orta Profil Klips**  
Double Middle Profile Clip

Paket İçi Adet Quantity Per Package	500	Koli İçi Adet Quantity Per Box	1.000
----------------------------------------	-----	-----------------------------------	-------



**Kuş Gözü (Metal) 4 mm** **Kuş Gözü (Metal) 3 mm**  
Rivet (Metal) 4 mm Rivet (Metal) 3 mm

Paket İçi Adet Quantity Per Package	5.000	Koli İçi Adet Quantity Per Box	5.000
----------------------------------------	-------	-----------------------------------	-------



**Kuş Gözü (Plastik)**  
Rivet (Plastic)

Paket İçi Adet Quantity Per Package	5.000	Koli İçi Adet Quantity Per Box	10.000
----------------------------------------	-------	-----------------------------------	--------

PRD 47



**Çiftli Orta Profil Klips Anahtarı (Metal)**  
Double Middle Profile Clip Key (Metal)

Paket İçi Adet Quantity Per Package	1	Koli İçi Adet Quantity Per Box	1
----------------------------------------	---	-----------------------------------	---

PRD 35



**Perde Çekme Aparatı**  
Curtain Pulling Apparatus

Paket İçi Adet Quantity Per Package	1	Koli İçi Adet Quantity Per Box	1
----------------------------------------	---	-----------------------------------	---

PRD 34



**Montaj Vidası (2,9x6,5 YHB)**  
Mounting Screw (2.9x6.5 YHB)

Koli İçi Adet Quantity Per Box	10.000
-----------------------------------	--------

PRD 34



**Portray Profil Metal Klips**  
Portray Profile Metal Clip

Paket İçi Adet Amount within package	500	Koli İçi Adet Amount within parcel	1.000
-----------------------------------------	-----	---------------------------------------	-------

PRD 42



**Yapışkan Profili Yayı**  
Adhesive Profile Spring

Paket İçi Adet Amount within package	100	Koli İçi Adet Amount within parcel	500
-----------------------------------------	-----	---------------------------------------	-----

PRD 44



**Yaylı Portray Klips**  
Spring Portray Clip

Koli İçi Adet Quantity Per Box	1.000
-----------------------------------	-------

PRD 30

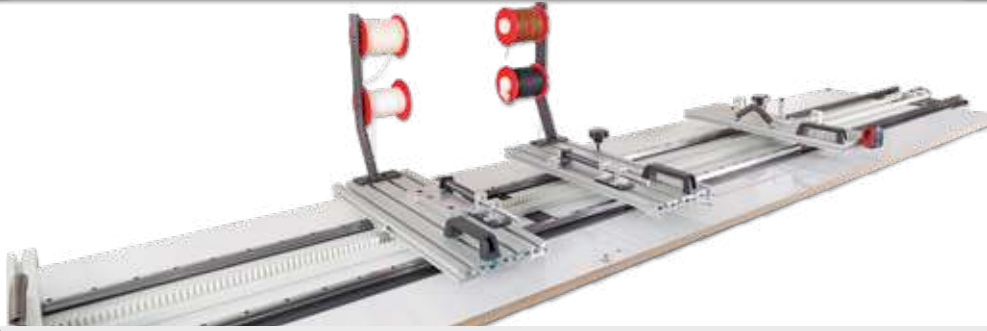

İp Ayar Boylama Tezgahı  
Rope Adjustment Lengthening Machine

PRD 31



Kumaş Delme Makinesi  
Fabric Punching Machine

PRD 32



Kumaş Kesim Makinesi  
Fabric Cutting Machine

PRD 31 A



Petek Kumaş Delme Makinesi  
Cellular Fabric Punching Machine

PRD 33



Perçin Makinesi  
Rivet Machine





**T Profil**  
T Profile

Paket İçi Adet Quantity Per Package	10	Gramajı Weight	0,167 kg/m
----------------------------------------	----	-------------------	------------



**20'lik T Profil**  
20 T Profile

Paket İçi Adet Quantity Per Package	10	Gramajı Weight	0,265 kg/m
----------------------------------------	----	-------------------	------------



**Yaylı Yapışkan Profil**  
Spring Adhesive Profile

Paket İçi Adet Quantity Per Package	10	Gramajı Weight	0,102 kg/m
----------------------------------------	----	-------------------	------------



**Small T Profil**  
Small T Profile

Paket İçi Adet Quantity Per Package	10	Gramajı Weight	0,094 kg/m
----------------------------------------	----	-------------------	------------



**Yaylı Portray Profil**  
Spring Portray Profile

Paket İçi Adet Quantity Per Package	10	Gramajı Weight	0,076 kg/m
----------------------------------------	----	-------------------	------------



**Çiftli Orta Profil**  
Double Middle Profile

Paket İçi Adet Quantity Per Package	10	Gramajı Weight	0,252 kg/m
----------------------------------------	----	-------------------	------------



**Portray Yapışkan Profil**  
Adhesive Profile

Paket İçi Adet Amount within package	10	Gramajı Weight	0,105 kg/m
-----------------------------------------	----	-------------------	------------



**Etekli T Profil**  
Extended T Profile

Paket İçi Adet Amount within package	10	Gramajı Weight	0,162 kg/m
-----------------------------------------	----	-------------------	------------

## Alüminyum Renk Seçeneği

Aluminum Color Options

9016

Beyaz  
White



Eloksal Boyalı  
Anodized Painted



Bronz Boyalı  
Bronze Painted

8003

Altın Meşe  
Golden Oak

8016

Maun  
Mahogany

7016

Antrasit Gri  
Anthracite Gray

9005

Siyah  
Black





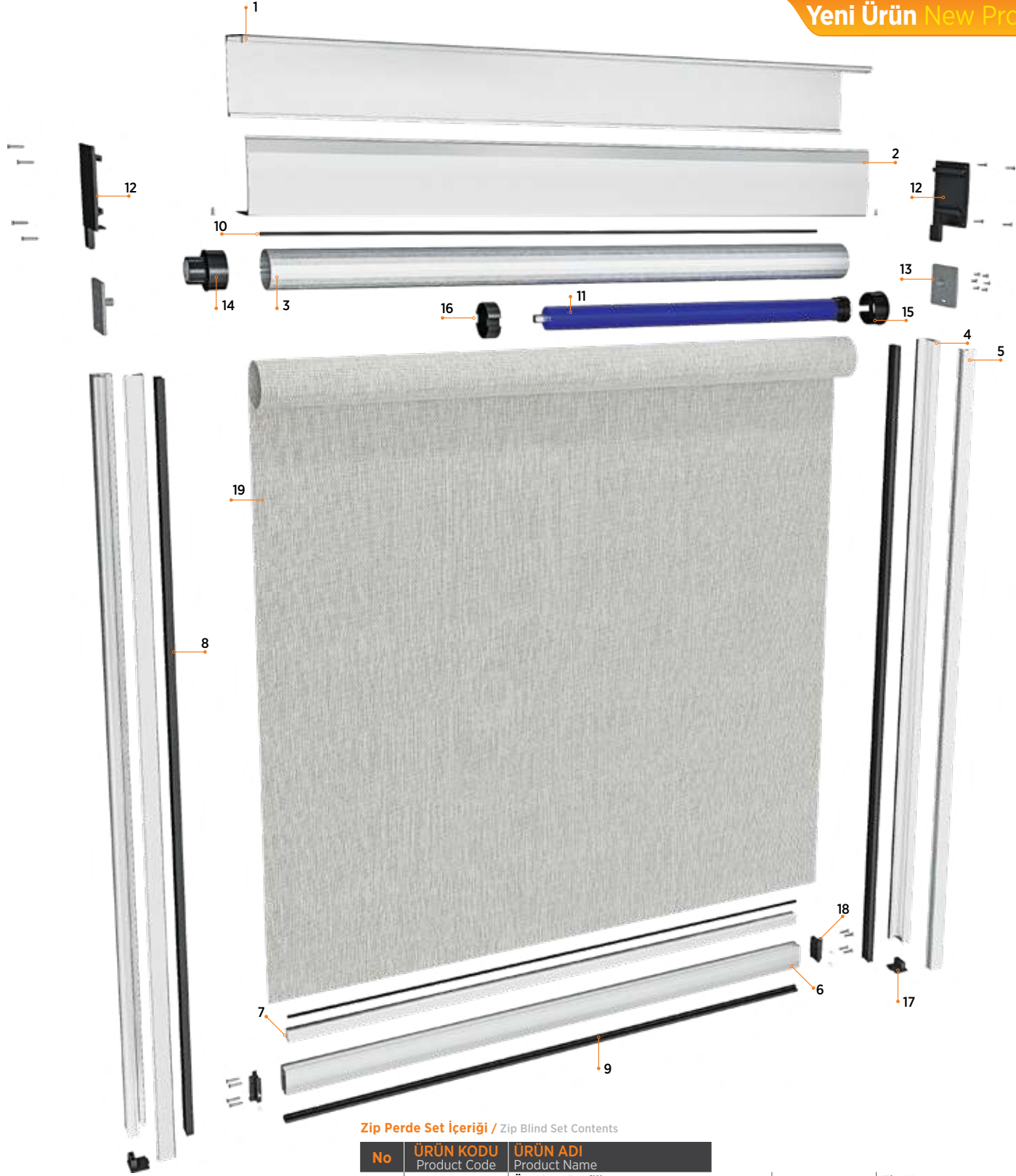

Zip Perde Set İçeriği / Zip Blind Set Contents

No	ÜRÜN KODU Product Code	ÜRÜN ADI Product Name
1	7150	Üst Kasa Profili Upper Case Profile
2	7151	Üst Kasa Kapak Profili Upper Case Cover Profile
3	ZP 13	Sac Tambur Borusu Sheet Drum Tube
4	251	Yan Kasa Profili Side Case Profile
5	252	Yan Kasa Kapak Profili Side Case Cover Profile
6	250	Kanat Profili Wing Profile
7	ZP 15	5x20 Lama Demir 5x20 Blade Iron
8	ZP 09	Fermuar Aparatı Zipper Apparatus
9	ZP 10	Kanat Contası Wing Seal
10	ZP 11	Perde Plastiği Curtain Plastic

11	-	Zip Motor Zip Engine
12	ZP 01	Üst Kasa Kapak - Sağ/Sol Upper Case Cover - Right/Left
13	ZP 02	Çelik Pimli Motor Bağlantı Parçası Steel Pinned Motor Connection Part
14	ZP 03	Rulmanlı Tambur Bağlantı Bearing Drum Connection
15	ZP 04	Motorlu Tambur Bağlantı Motorized Drum Connection
16	ZP 05	Rotor Aktarma Parçası Rotor Transmission Part
17	ZP 06	Yan Kasa Kapakları - Sağ/Sol Side Case Covers - Right/Left
18	ZP 07	Kanat Kapakları Wing Covers
19	-	Zip Perde Zip Blind

Zip perdeler, özellikle evler, restoranlar, kafeler, oteller ve ticari binalar gibi birçok farklı mekan için popüler bir seçenektir. Bu perdeler, iç mekan konforunu artırmak ve enerji tasarrufu sağlamak için kullanışlıdır.

Zip blinds are a popular choice for various settings, including homes, restaurants, cafes, hotels, and commercial buildings. They are useful for enhancing indoor comfort and promoting energy efficiency.

ZP 01

Siyah  
Black



Üst Kasa Kapak - Sağ/Sol  
Upper Case Cover - Right/Left

Paket İçi Adet Quantity Per Package	10	Koli İçi Adet Quantity Per Box	20
----------------------------------------	----	-----------------------------------	----

ZP 02

Gri  
Grey



Çelik Pimli Motor Bağlantı Parçası  
Steel Pinned Motor Connection Part

Paket İçi Adet Quantity Per Package	20	Koli İçi Adet Quantity Per Box	20
----------------------------------------	----	-----------------------------------	----

ZP 03

Siyah  
Black



Rulmanlı Tambur Bağlantı  
Bearing Drum Connection

Paket İçi Adet Quantity Per Package	10	Koli İçi Adet Quantity Per Box	10
----------------------------------------	----	-----------------------------------	----

ZP 04

Siyah  
Black



Motorlu Tambur Bağlantı  
Motorized Drum Connection

Paket İçi Adet Quantity Per Package	10	Koli İçi Adet Quantity Per Box	10
----------------------------------------	----	-----------------------------------	----

ZP 05

Siyah  
Black



Rotor Aktarma Parçası  
Rotor Transmission Part

Paket İçi Adet Quantity Per Package	10	Koli İçi Adet Quantity Per Box	10
----------------------------------------	----	-----------------------------------	----

ZP 06

Siyah  
Black



Yan Kasa Kapakları - Sağ/Sol  
Side Case Covers - Right/Left

Paket İçi Adet Quantity Per Package	10	Koli İçi Adet Quantity Per Box	20
----------------------------------------	----	-----------------------------------	----

ZP 07

Siyah  
Black



Kanat Kapak  
Wing Cover

Paket İçi Adet Quantity Per Package	40	Koli İçi Adet Quantity Per Box	40
----------------------------------------	----	-----------------------------------	----

ZP 09

Siyah  
Black



Fermuar Aparatı  
Zipper Apparatus

Paket İçi Adet Quantity Per Package	20	Koli İçi Adet Quantity Per Box	20
----------------------------------------	----	-----------------------------------	----

ZP 10

Siyah  
Black



Kanat Contası  
Wing Seal

Paket İçi Adet Quantity Per Package	125 m	Koli İçi Adet Quantity Per Box	125 m
----------------------------------------	-------	-----------------------------------	-------

ZP 11

Siyah  
Black



Perde Plastiği  
Curtain Plastic

Paket İçi Adet Quantity Per Package	1.500 m	Koli İçi Adet Quantity Per Box	1.500 m
----------------------------------------	---------	-----------------------------------	---------

ZP 15



5x20 Lama Demir  
5x20 Blade Iron

Paket İçi Adet Quantity Per Package	0,800 kg/m	Gramajı Weight	0,800 kg/m
----------------------------------------	------------	-------------------	------------

ZP 08

Siyah  
Black



Perde Fermuarı  
Blind Zipper

Paket İçi Adet Quantity Per Package	200 m	Koli İçi Adet Quantity Per Box	200 m
----------------------------------------	-------	-----------------------------------	-------

ZP 14 **Somfy**  
**somfy.**



Motor (35 Nm)  
Engine (35 Nm)

KMD 1 **Somfy**  
**somfy.**



Kumanda (Tekli)  
Engine Remote Control (Mono)

KMD 2 **Somfy**  
**somfy.**



Kumanda (Çoklu)  
Engine Remote Control (Multi)

ZP 16 **A-OK**  
**A-OK**



Motor (20-40 Nm)  
Engine (20-40 Nm)

KMD 3 **A-OK**  
**A-OK**



Kumanda (Tekli)  
Engine Remote Control (Mono)

KMD 4 **A-OK**  
**A-OK**



Kumanda (Çoklu)  
Engine Remote Control (Multi)



### Güneş Işığı Kontrolü:

Zip perdeler, güneş ışığını isteğe bağlı olarak engelleyebilir veya iç mekana geçirilebilir. Bu, iç mekanın aydınlatmasını ve sıcaklığını ayarlamak için kullanışlıdır.

### Sunlight Control:

Zip blinds can either block or allow sunlight to enter the interior as desired, making it convenient for adjusting indoor lighting and temperature.



### Rüzgar Dayanıklılığı:

Bu perdeler, dayanıklı ve rüzgarlı hava koşullarına karşı dirençli olarak tasarlanır. Rüzgarla temas ettiğinde dengeli ve sabit kalırlar.

### Wind Resistance:

These blinds are designed to withstand strong and windy weather conditions, remaining stable even when in contact with the wind.



### Sineklik İşlevi:

Zip perdeler, açık havada oturma alanları veya teraslar için idealdir. Aynı zamanda sineklik işlevi görebilir ve böceklerin içeri girmesini engelleyebilir.

### Insect Protection:

Zip blinds are ideal for outdoor seating areas or terraces, as they can also function as insect screens, preventing bugs from entering.



### Uzun Ömür:

Kaliteli malzemelerle yapıldığında, zip perdeler uzun yıllar boyunca dayanıklılık ve performans sunabilirler.

### Longevity:

When made from high-quality materials, zip blinds can offer durability and long-lasting performance.





250

**Kanat Profili**  
Wing Profile

Paket İçi Adet Quantity Per Package	3	Gramajı Weight	1,288 kg/m
----------------------------------------	---	-------------------	------------



251

**Yan Kasa Profili**  
Side Case Profile

Paket İçi Adet Quantity Per Package	6	Gramajı Weight	0,572 kg/m
----------------------------------------	---	-------------------	------------



252

**Yan Kasa Kapak Profili**  
Side Case Cover Profile

Paket İçi Adet Quantity Per Package	10	Gramajı Weight	0,313 kg/m
----------------------------------------	----	-------------------	------------



7150

**Üst Kasa Profili**  
Upper Case Profile

Paket İçi Adet Quantity Per Package	2	Gramajı Weight	1,776 kg/m
----------------------------------------	---	-------------------	------------



7151

**Üst Kasa Kapak Profili**  
Upper Case Cover Profile

Paket İçi Adet Quantity Per Package	2	Gramajı Weight	1,475 kg/m
----------------------------------------	---	-------------------	------------



ZP 13

**Sac Tambur Borusu**  
Sheet Drum Tube

Paket İçi Adet Quantity Per Package	1	Gramajı Weight	2,110 kg/m
----------------------------------------	---	-------------------	------------



## Zip Perde

Zip perde sistemleri, dış mekanları veya büyük cam yüzeyleri rüzgar, güneş ışığı ve böcekler gibi dış etkenlere karşı korumak ve kontrol altına almak için kullanılan özel bir pencere kaplama çözümdür. Zip perdeler, aynı zamanda "screen perdeleri" olarak da adlandırılır ve aşağıdaki özelliklere sahiptir:

## Zip Blinds

Zip blind systems are a specialized window covering solution used to protect and control outdoor spaces or large glass surfaces from external factors such as wind, sunlight, and insects. Zip blinds are also called as "screen blinds" and have the following features:

### Fonksiyonellik:

Zip perdeler, güneş ışığına karşı koruma sağlar ve iç mekan sıcaklığını kontrol etmek için kullanılır. Aynı zamanda yağmur, rüzgar ve böcekler gibi dış etkenlere karşı da koruma sunar.

### Functionality:

Zip blinds provide protection against sunlight and are used to control indoor temperatures. They also offer protection against external elements like rain, wind, and insects.



### Estetik Tasarım:

Zip perdeler, modern ve şık bir görünüme sahiptir. Dikey yönde çalışabilen bir sistemle tasarlanırlar ve bu, farklı pencere türlerine uygunluk sağlar.

### Aesthetic Design:

Zip blinds have a modern and stylish appearance and can be designed with a system that operates vertically, making them suitable for various types of windows.



### Kullanım Kolaylığı:

Otomatik kontrol seçenekleri mevcuttur. Otomasyon, kullanım kolaylığı sağlar ve perdelerin istenen pozisyonda sabit kalmasını sağlar.

### Ease of Use:

Zip blinds come with automatic options, providing convenience and allowing the blinds to stay in the desired position.

# ALÜMİNYUM PROFİL GRUBU

Aluminium Profile Group

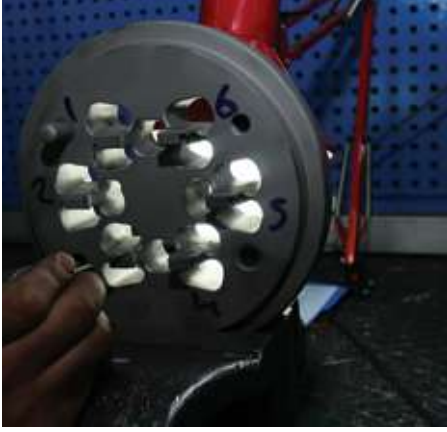

ISO 9001 | ISO 14001 | OHSAS 18001

## GOLD SERİ PLİSE SİNEKLİK / GOLD SERIES PLAIT FLY SCREEN

304

0,318 kg/m

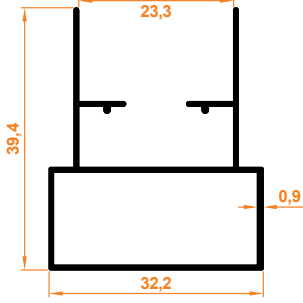

**Gold Kasa Profil**  
Gold Case Profile

Paket İçi Adet  
Quantity Per Package | 10

305

0,330 kg/m

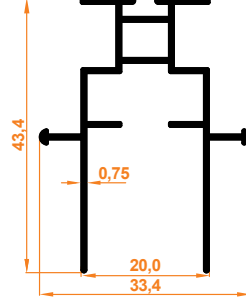

**Gold Kanat Profil**  
Gold Wing Profile

Paket İçi Adet  
Quantity Per Package | 10

## STAR SERİ PLİSE SİNEKLİK / STAR SERIES PLAIT FLY SCREEN

356

0,271 kg/m

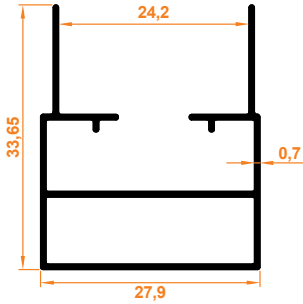

**Star Kasa Profil**  
Star Case Profile

Paket İçi Adet  
Quantity Per Package | 10

307

0,304 kg/m

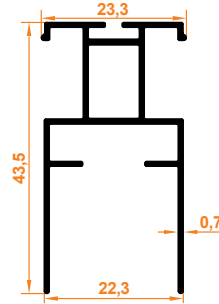

**Star Kanat Profil**  
Star Wing Profile

Paket İçi Adet  
Quantity Per Package | 10

## JUNIOR SERİ PLİSE SİNEKLİK / JUNIOR SERIES PLAIT FLY SCREEN

306

0,243 kg/m

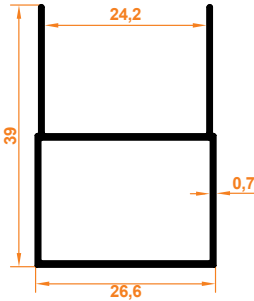

**Junior Kasa Profil**  
Junior Case Profile

Paket İçi Adet  
Quantity Per Package | 10

307

0,304 kg/m

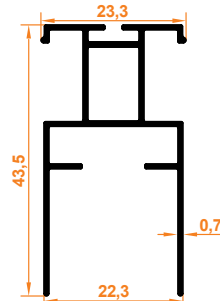

**Junior Kanat Profil**  
Junior Wing Profile

Paket İçi Adet  
Quantity Per Package | 10

345

0,162 kg/m

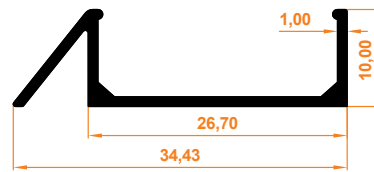

**Junior Eşiksiz Kasa Profil**  
Junior Case Profile without Threshold

Paket İçi Adet  
Quantity Per Package | 12

347

0,445 kg/m

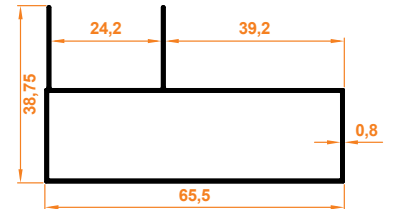

**Junior Büyük Kasa Profili**  
Junior Big Case Profile

Paket İçi Adet  
Quantity Per Package | 8

**SLIM SERİ PLİSE SİNEKLİK / SLIM SERIES PLAİT FLY SCREEN**

**300**

**0,218 kg/m**

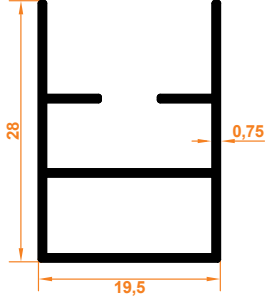

**Slim Kasa Profil**  
Slim Case Profile

Paket İçi Adet  
Quantity Per Package

10

**358**

**0,111 kg/m**

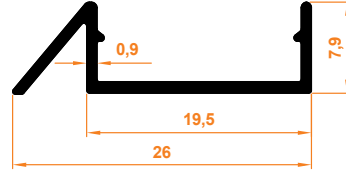

**Slim Eşiksiz Profil**  
Slim Profile without Threshold

Paket İçi Adet  
Quantity Per Package

12

**359**

**0,321 kg/m**

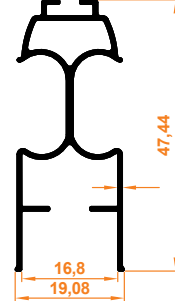

**Slim Kant Profil**  
Slim Wing Profile

Paket İçi Adet  
Quantity Per Package

10

**NOBEL SERİ PLİSE SİNEKLİK / NOBEL SERIES PLAİT FLY SCREEN**

**335**

**0,345 kg/m**

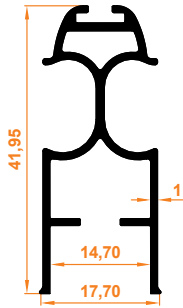

**Nobel Kanat Profili**  
Nobel Wing Profile

Paket İçi Adet  
Quantity Per Package

10

**355**

**0,098 kg/m**

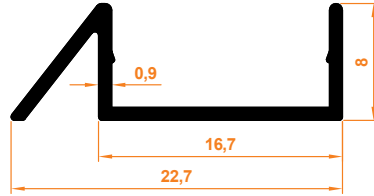

**Nobel Eşiksiz Profili**  
Nobel Profile without Threshold

Paket İçi Adet  
Quantity Per Package

12

**338**

**0,250 kg/m**

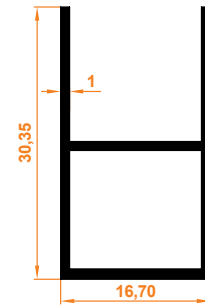

**Nobel Kasa Profili**  
Nobel Case Profile

Paket İçi Adet  
Quantity Per Package

10



## SÜPER SERİ PLİSE SİNEKLİK / SUPER SERIES PLAIT FLY SCREEN

320

0,303 kg/m

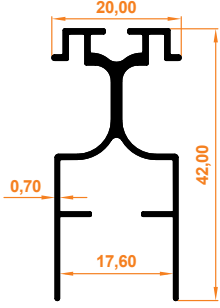

**Süper Seri Kanat Profili**  
Super Wing Profile

Paket İçi Adet  
Quantity Per Package

10

316

0,248 kg/m

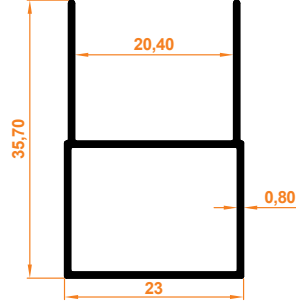

**Süper Seri Kasa Profili**  
Super Case Profile

Paket İçi Adet  
Quantity Per Package

10

325

0,469 kg/m

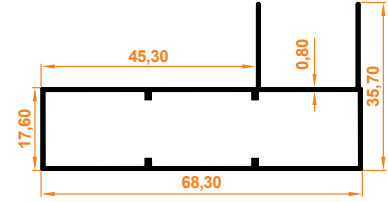

**Süper Büyük Kasa Profili**  
Super Big Case Profile

Paket İçi Adet  
Quantity Per Package

8

354

0,363 kg/m

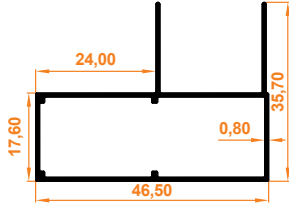

**Süper Orta Kasa Profili**  
Super Middle Case Profile

Paket İçi Adet  
Quantity Per Package

8

361

0,152 kg/m

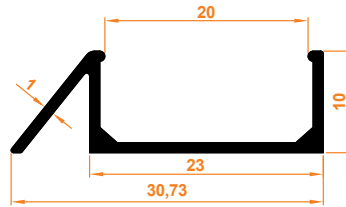

**Süper Eşiksiz Kasa Profili**  
Super without Threshold Case Profile

Paket İçi Adet  
Quantity Per Package

12

**NOBEL SERİ İÇTEN MONTAJLI PLİSE SİNEKLİK / NOBEL SERIES INTERNAL MOUNTED PLAIT FLY SCREEN**

363

0,338 kg/m

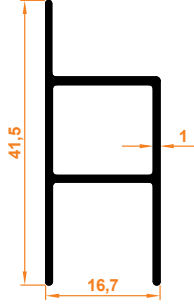

**Nobel İçten/Dıştan Montajlı Kasa Profil**  
Nobel Inside/Outside Mounted Case Profile

Paket İçi Adet  
Quantity Per Package | 10

335

0,345 kg/m

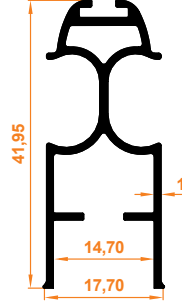

**Nobel Kanat Profili**  
Nobel Wing Profile

Paket İçi Adet  
Quantity Per Package | 10

**SLIM SERİ İÇTEN MONTAJLI PLİSE SİNEKLİK / SLIM SERIES INTERNAL MOUNTED PLAIT FLY SCREEN**

317

0,272 kg/m

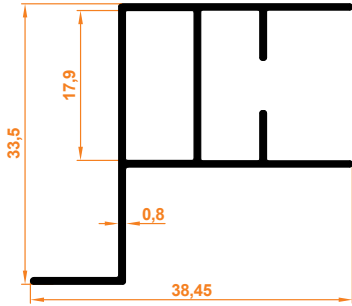

**Slim Seri İçten Montajlı Kasa Profil**  
Slim Series Internally Mounted Frame Profile

Paket İçi Adet  
Quantity Per Package | 10

359

0,321 kg/m

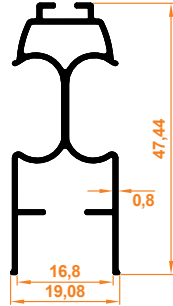

**Slim Kanat Profili**  
Slim Sash Profile

Paket İçi Adet  
Quantity Per Package | 10

**İÇTEN MONTAJLI SABİT SİNEKLİK / INTERNAL MOUNTED FIXED FLY SCREEN**

405

0,256 kg/m

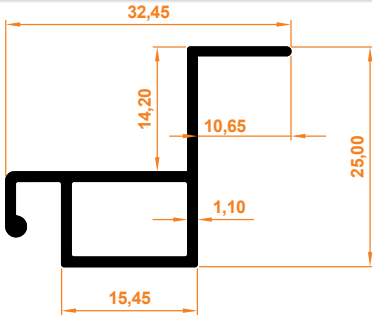

**İçten Montajlı Sabit Sineklik Kasa Profil**  
Internally Mounted Fixed Fly Screen Frame Profile

Paket İçi Adet  
Quantity Per Package | 10

## AYKİM SERİ SİNEKLİK / AYKİM SERIES FLY SCREEN

309

0,374 kg/m

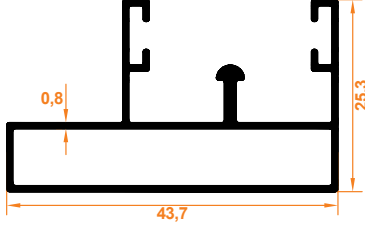

**Aykim Kasa Profil**  
Aykim Case Profile

Paket İçi Adet  
Quantity Per Package

8

310

0,315 kg/m

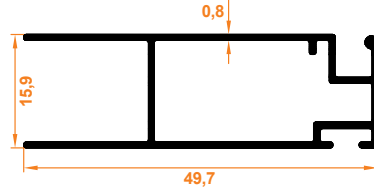

**Aykim Hareketli Profil**  
Aykim Sliding Profile

Paket İçi Adet  
Quantity Per Package

10

## PLATİN SERİ SİNEKLİK / PLATİN SERIES FLY SCREEN

321

0,352 kg/m

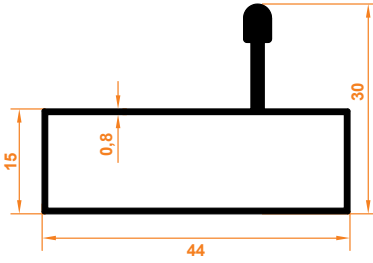

**Platin Tekli Kasa Profil**  
Platin Single Case Profile

Paket İçi Adet  
Quantity Per Package

8

322

0,455 kg/m

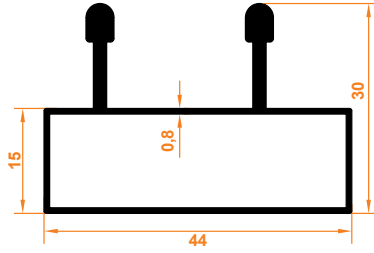

**Platin Çiftli Kasa Profil**  
Platin Double Case Profile

Paket İçi Adet  
Quantity Per Package

6

323

0,506 kg/m

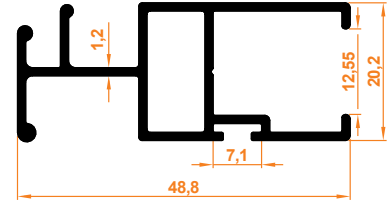

**Platin Kanat Profil**  
Platin Series Sash Profile

Paket İçi Adet  
Quantity Per Package

10

360

0,306 kg/m

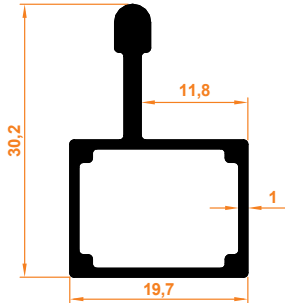

**Platin Tekli Dar Kasa Profil**  
Platin Series Single Slim Frame Profile

Paket İçi Adet  
Quantity Per Package

8

**DÜZ SİNEKLİK SİSTEMLERİ / FLAT FLY SCREEN PROFILE GROUP**

400

0,105 kg/m

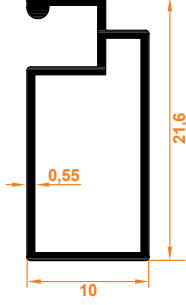

**10x20 Sineklik Profil**  
10x20 Fly Screen Profile

Paket İçi Adet  
Quantity Per Package

20

401

0,142 kg/m

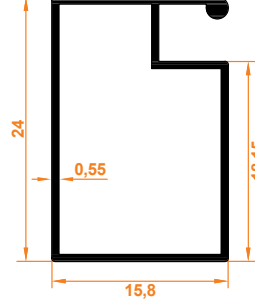

**17x25 Sineklik Profil**  
17x25 Fly Screen Profile

Paket İçi Adet  
Quantity Per Package

20

402

0,250 kg/m

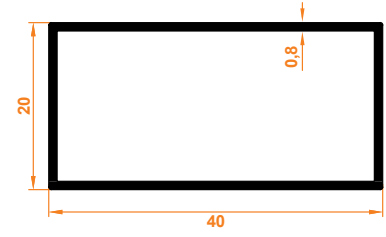

**20x40 Sineklik Profil**  
20x40 Fly Screen Profile

Paket İçi Adet  
Quantity Per Package

10

311

0,304 kg/m

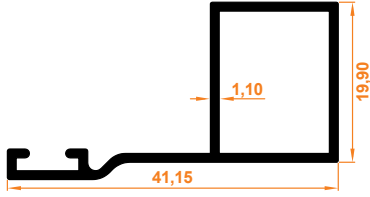

**İçe Açılır Fitilli Sineklik Profil**  
Inward Foldable Flyscreen Profile

Paket İçi Adet  
Quantity Per Package

10

# STOR SİNEKLİK PROFİL GRUBU

Stor Fly Screen Profile Group

407

0,342 kg/m

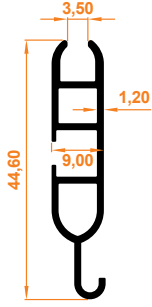

**Stor Kanat Profil**  
Stor Wing Profile

Paket İçi Adet  
Quantity Per Package

6

408

0,286 kg/m

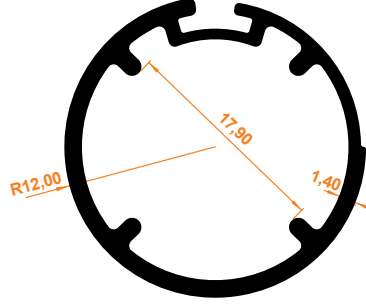

**Stor Boru Profil**  
Stor Pipe Profile

Paket İçi Adet  
Quantity Per Package

6

409

0,526 kg/m

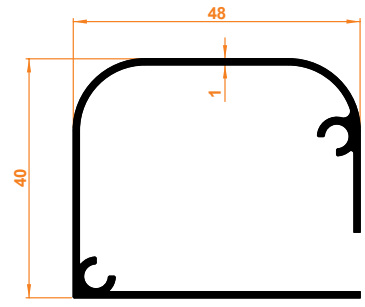

**Stor Kasa Profil**  
Stor Case Profile

Paket İçi Adet  
Quantity Per Package

6

410

0,413 kg/m

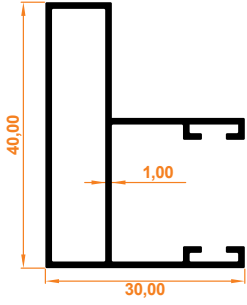

**Stor Yan Kasa Profil**  
Stor Side Case Profile

Paket İçi Adet  
Quantity Per Package

6

411

0,318 kg/m

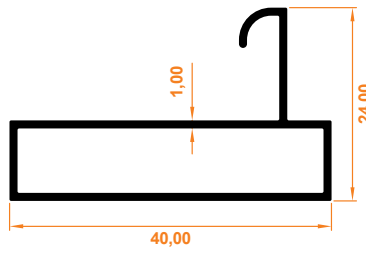

**Stor Alt Kasa Profil**  
Stor Bottom Case Profile

Paket İçi Adet  
Quantity Per Package

6

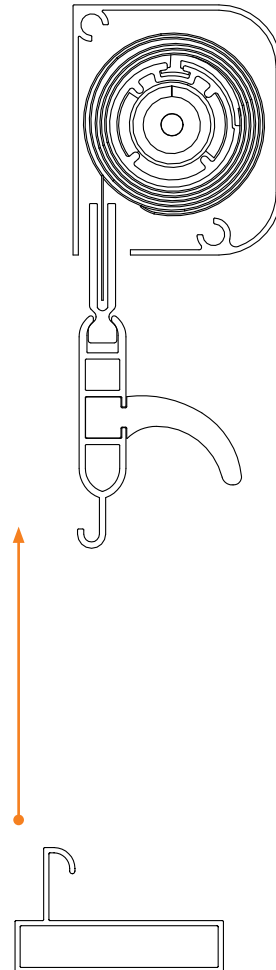
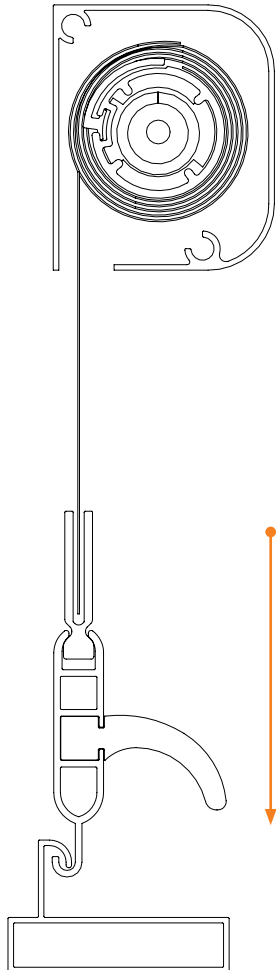

1

0,247 kg/m

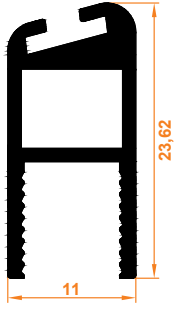

**Büyük D Fitol**  
Big D Wick

Paket İçi Adet  
Quantity Per Package

10

2

0,167 kg/m

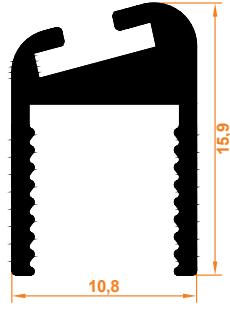

**Küçük D Fitol**  
Small D Wick

Paket İçi Adet  
Quantity Per Package

10

3

0,116 kg/m

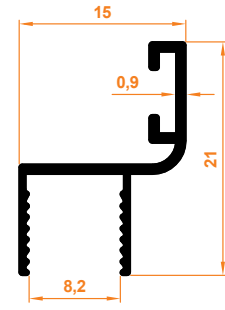

**Küçük h Fitol**  
Small h Wick

Paket İçi Adet  
Quantity Per Package

20

4

0,150 kg/m

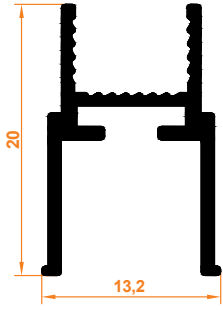

**Orta H Fitol**  
Medium H Wick

Paket İçi Adet  
Quantity Per Package

10

5

0,214 kg/m

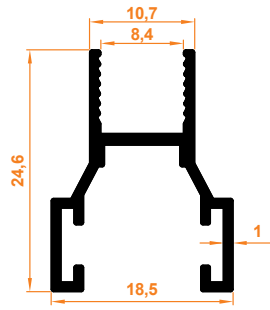

**Büyük H Fitol**  
Big H Wick

Paket İçi Adet  
Quantity Per Package

20

6

0,276 kg/m

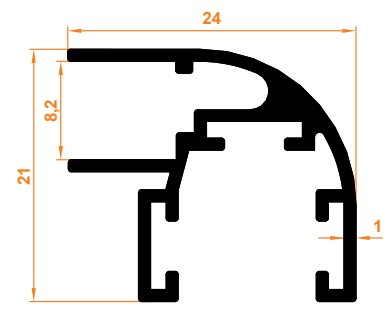

**Köşe Dönüş Fitol**  
Corner Return Wick

Paket İçi Adet  
Quantity Per Package

10

# 8 mm CAM BALKON PROFİL GRUBU

8 mm Glass Balcony Profile Group

101

0,078 kg/m

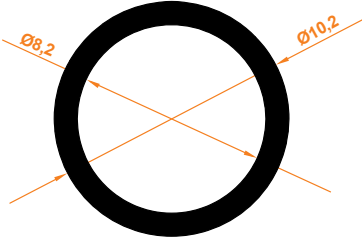

**10'lu Stoplama**  
10 Stopping Profile

Paket İçi Adet  
Quantity Per Package

25

104

0,717 kg/m

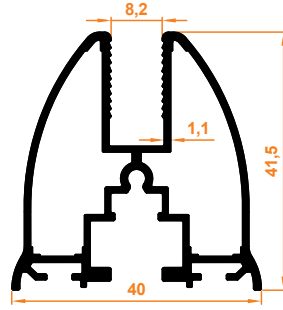

**Gold Baza Profil**  
Gold Base Profile

Paket İçi Adet  
Quantity Per Package

3

105

0,730 kg/m

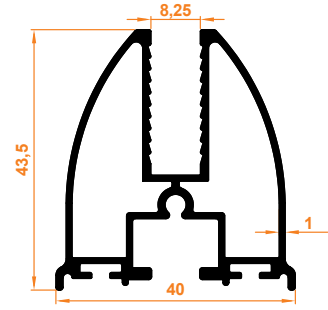

**Firtına Baza Profil**  
Firtına Base Profile

Paket İçi Adet  
Quantity Per Package

3

109

1,355 kg/m

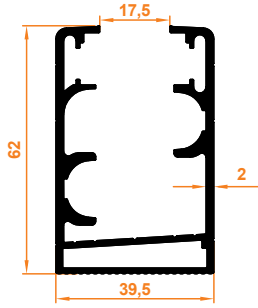

**Düz Kasa Profil**  
Flat Case Profile

Paket İçi Adet  
Quantity Per Package

3

110

1,396 kg/m

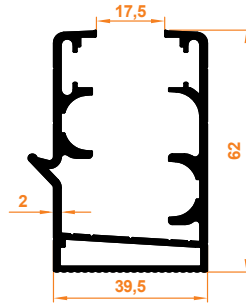

**Oluklu Kasa Profil**  
Corrugated Case Profile

Paket İçi Adet  
Quantity Per Package

3

100

0,441 kg/m

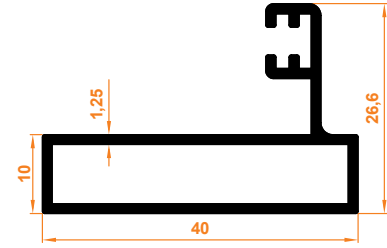

**Dar Yan Dikme**  
Thin Side Column

Paket İçi Adet  
Quantity Per Package

6

106

1,611 kg/m

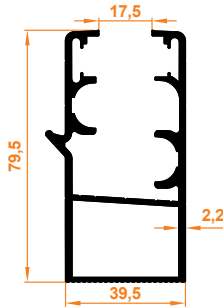

**Oluklu Büyük Kasa Profil**  
Corrugated Big Case Profile

Paket İçi Adet  
Quantity Per Package

3

107

1,570 kg/m

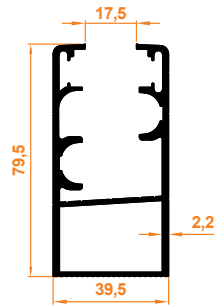

**Büyük Düz Kasa Profil**  
Big Flat Case Profile

Paket İçi Adet  
Quantity Per Package

3

108

0,457 kg/m

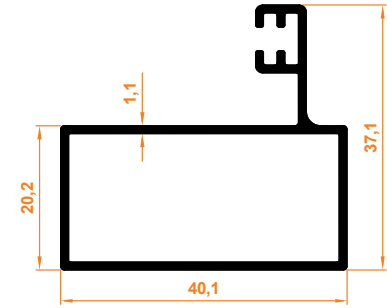

**Geniş Yan Dikme**  
Thick Side Column Profile

Paket İçi Adet  
Quantity Per Package

6

111

1,062 kg/m

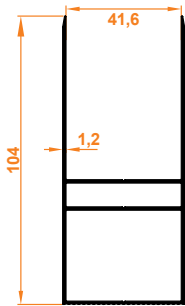

**Stor Profil**  
Stor Profile

Paket İçi Adet  
Quantity Per Package

3

135

0,517 kg/m

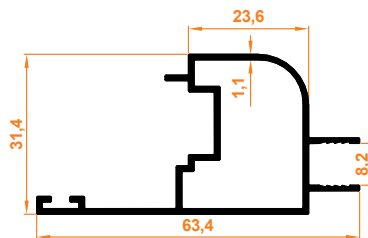

**8 mm İspanyolet Profil**  
8 mm Espagnolette Profile

Paket İçi Adet  
Quantity Per Package

4

136

0,343 kg/m

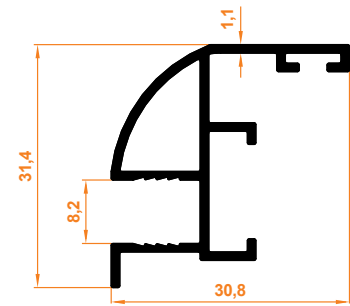

**8 mm İspanyolet Profil Karşılığı**  
8 mm Espagnolette Combination Profile

Paket İçi Adet  
Quantity Per Package

8

800

0,618 kg/m

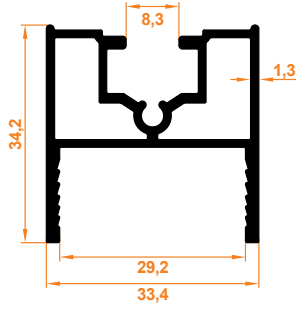

**Baza Profil**  
Base Profile

Paket İçi Adet | 6  
Quantity Per Package

801

0,321 kg/m

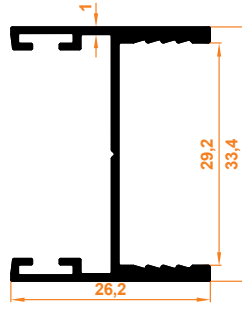

**Düz Kapak Profil**  
Flat Cover Profile

Paket İçi Adet | 6  
Quantity Per Package

802

0,327 kg/m

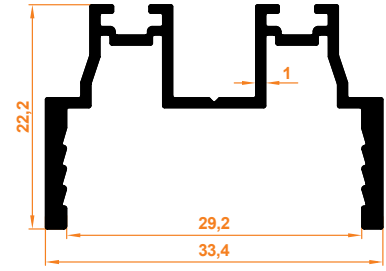

**Düz Kapak Mentеше Profil**  
Flat Cover with Hinge Profile

Paket İçi Adet | 6  
Quantity Per Package

803

0,445 kg/m

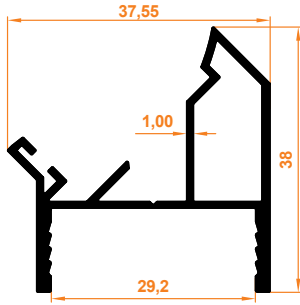

**45° Dönüş Profil**  
45° Return Profile

Paket İçi Adet | 6  
Quantity Per Package

804

0,378 kg/m

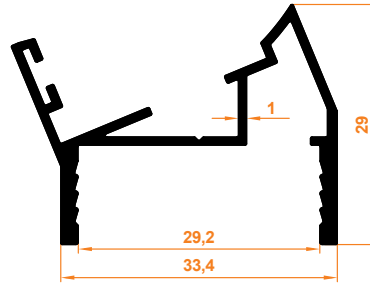

**22,5° Dönüş Profil**  
22,5° Return Profile

Paket İçi Adet | 6  
Quantity Per Package

805

0,366 kg/m

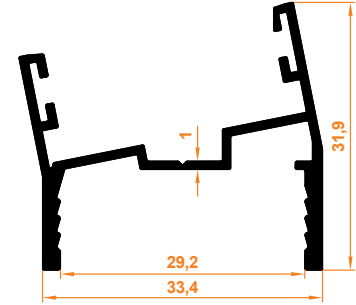

**11° Dönüş Profil**  
11° Return Profile

Paket İçi Adet | 6  
Quantity Per Package

806

0,475 kg/m

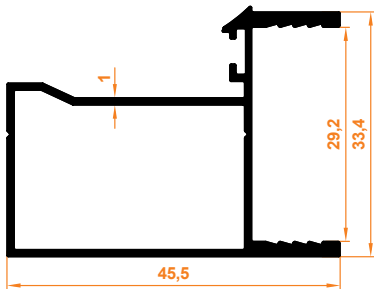

**90° Dönüş Profil**  
90° Return Profile

Paket İçi Adet | 6  
Quantity Per Package

807

0,346 kg/m

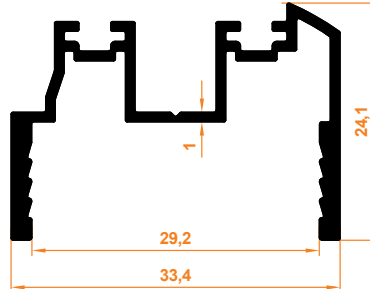

**Açılı Dönüş Mentеше Profil**  
PopUp Return Hinge Profile

Paket İçi Adet | 6  
Quantity Per Package

808

0,369 kg/m

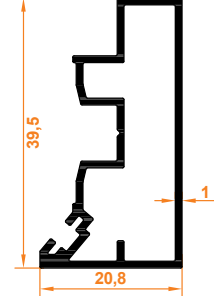

**Yan Dikme Profil**  
Side Column Profile

Paket İçi Adet | 6  
Quantity Per Package

809

0,328 kg/m

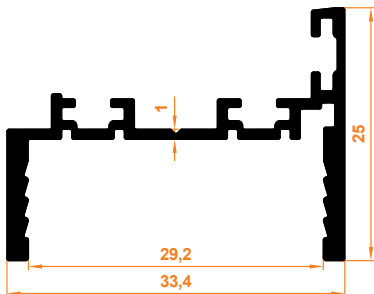

**Sabit Cam Mentеше Profil**  
Stable Glass Hinge Profile

Paket İçi Adet | 6  
Quantity Per Package

810

0,355 kg/m

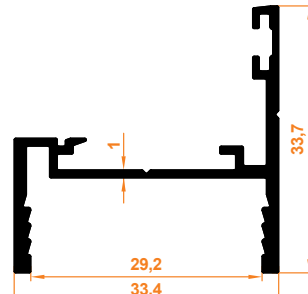

**Sabit Cam Kilit Profil**  
Stable Glass Lock Profile

Paket İçi Adet | 6  
Quantity Per Package

811

0,342 kg/m

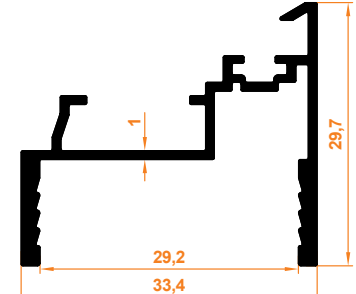

**Sabit Cam Kilit Karşılığı Profil**  
Stable Glass Lock Prevention Profile

Paket İçi Adet | 6  
Quantity Per Package



819

1,344 kg/m

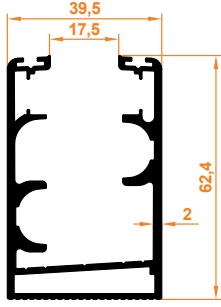

**Düz Kasa Üstten Fitilli Profil**  
Flat Case Top Wicked Profile

Paket İçi Adet  
Quantity Per Package

3

820

1,389 kg/m

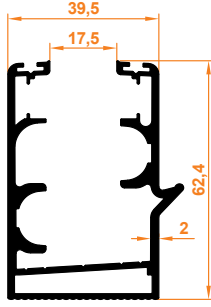

**Oluklu Kasa Üstten Fitilli Profil**  
Corrugated Case Top Wicked Profile

Paket İçi Adet  
Quantity Per Package

3

822

0,378 kg/m

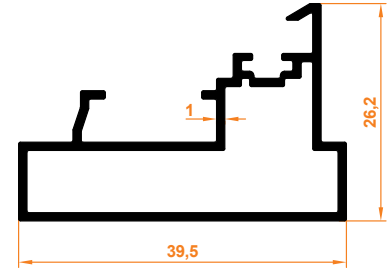

**Açılır Dikme Profil**  
PopUp Column Profile

Paket İçi Adet  
Quantity Per Package

6

816

1,577 kg/m

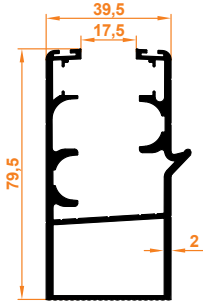

**Üstten Fitilli Büyük Oluklu Kasa**  
Large Corrugated Case with Top Wick

Paket İçi Adet  
Quantity Per Package

3

817

1,532 kg/m

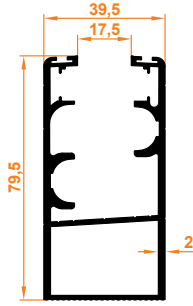

**Üstten Fitilli Büyük Düz Kasa**  
Large Flat Case with Wed from Top

Paket İçi Adet  
Quantity Per Package

3

815

0,100 kg/m

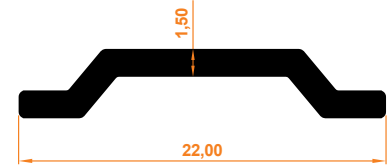

**Tij Profil**  
Espagnolette Profile

Paket İçi Adet  
Quantity Per Package

20

823

0,459 kg/m

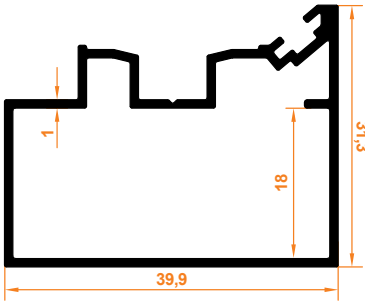

**Geniş Yan Dikme**  
Wide Side Column

Paket İçi Adet  
Quantity Per Package

6

824

0,583 kg/m

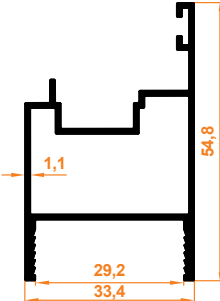

**Sabit Cam İspanyolet Profil**  
Fixed Glass Espagnolette Profile

Paket İçi Adet  
Quantity Per Package

6

825

0,356 kg/m

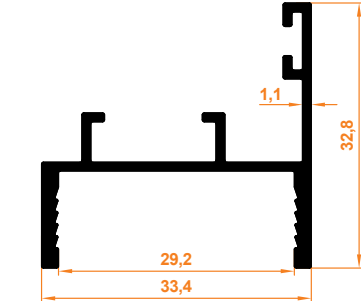

**Sabit Cam İspanyolet Karşılık Profil**  
Fixed Glass Espagnolette Handle Provision Profile

Paket İçi Adet  
Quantity Per Package

6

830

0,680 kg/m

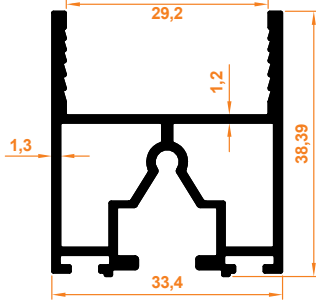

**Fitilli Baza Profili**  
Wicked Base Profile

Paket İçi Adet | 6  
Quantity Per Package

801

0,321 kg/m

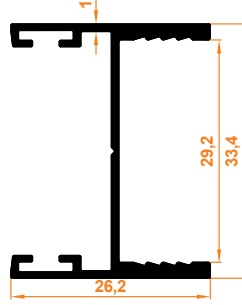

**Düz Kapak Profili**  
Flat Cover Profile

Paket İçi Adet | 6  
Quantity Per Package

802

0,327 kg/m

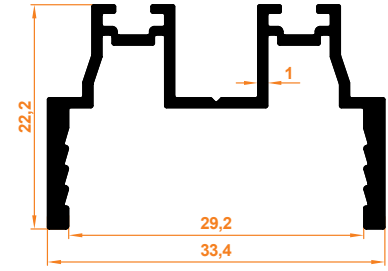

**Düz Kapak Menteşe Profili**  
Flat Cover with Hinge Profile

Paket İçi Adet | 6  
Quantity Per Package

803

0,445 kg/m

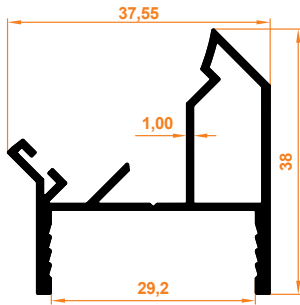

**45° Dönüş Profili**  
45° Return Profile

Paket İçi Adet | 6  
Quantity Per Package

804

0,378 kg/m

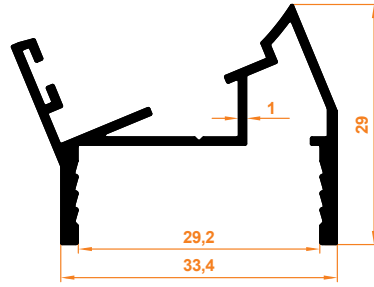

**22,5° Dönüş Profili**  
22,5° Return Profile

Paket İçi Adet | 6  
Quantity Per Package

805

0,366 kg/m

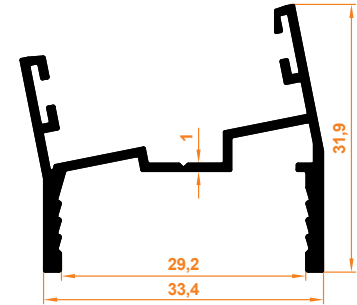

**11° Dönüş Profili**  
11° Return Profile

Paket İçi Adet | 6  
Quantity Per Package

806

0,475 kg/m

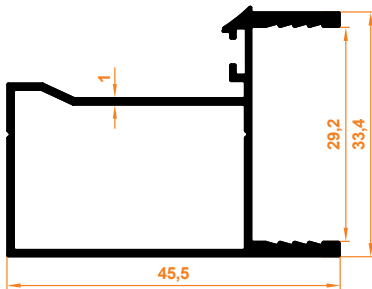

**90° Dönüş Profili**  
90° Return Profile

Paket İçi Adet | 6  
Quantity Per Package

807

0,346 kg/m

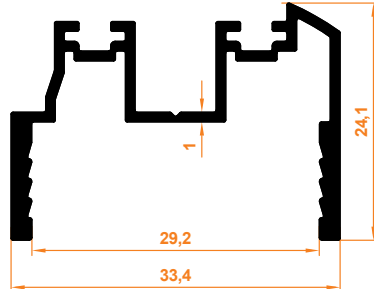

**Açılı Dönüş Menteşe Profili**  
PopUp Return Hinge Profile

Paket İçi Adet | 6  
Quantity Per Package

808

0,369 kg/m

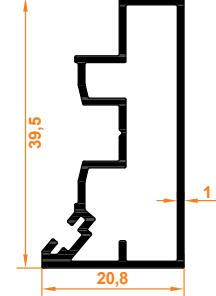

**Yan Dikme Profili**  
Side Column Profile

Paket İçi Adet | 6  
Quantity Per Package

809

0,328 kg/m

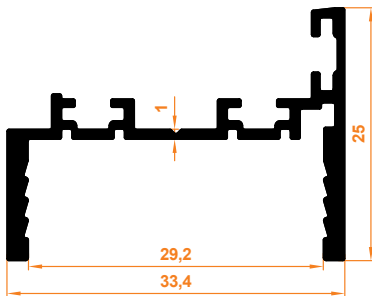

**Sabit Cam Menteşe Profili**  
Stable Glass Hinge Profile

Paket İçi Adet | 6  
Quantity Per Package

810

0,355 kg/m

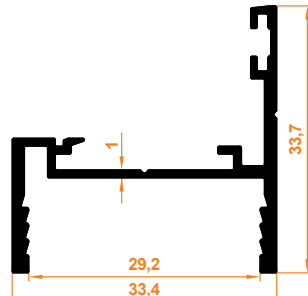

**Sabit Cam (Tijli) Kilit Profili**  
Stable Glass Lock Profile

Paket İçi Adet | 6  
Quantity Per Package

811

0,342 kg/m

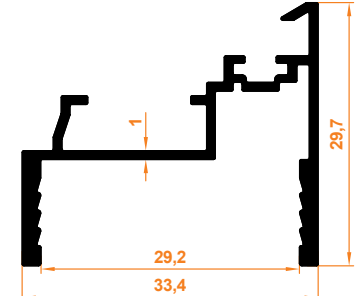

**Sabit Cam (Tijli) Kilit Karşılık Profili**  
Stable Glass Lock Prevention Profile

Paket İçi Adet | 6  
Quantity Per Package

109

1,355 kg/m

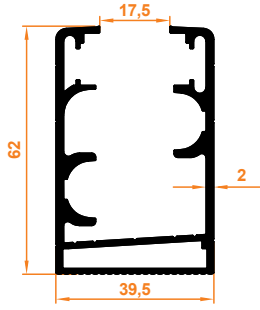

**Düz Kasa Profil**  
Flat Case Profile

Paket İçi Adet  
Quantity Per Package

3

110

1,396 kg/m

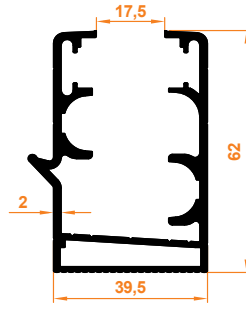

**Oluklu Kasa Profil**  
Corrugated Case Profile

Paket İçi Adet  
Quantity Per Package

3

822

0,378 kg/m

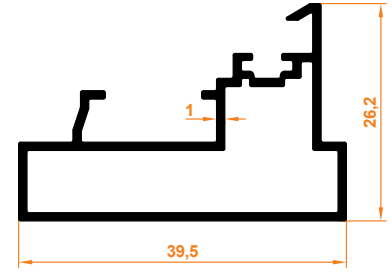

**Açılır Dikme Profil**  
PopUp Column Profile

Paket İçi Adet  
Quantity Per Package

6

106

1,611 kg/m

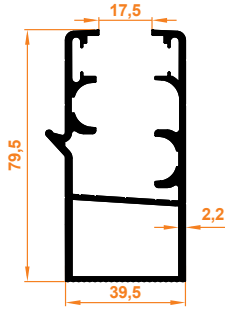

**Oluklu Büyük Kasa Profil**  
Corrugated Big Case Profile

Paket İçi Adet  
Quantity Per Package

3

107

1,570 kg/m

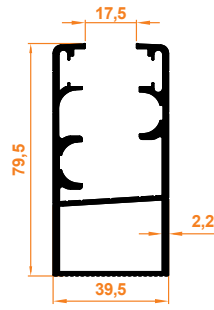

**Büyük Düz Kasa Profil**  
Big Flat Case Profile

Paket İçi Adet  
Quantity Per Package

3

823

0,459 kg/m

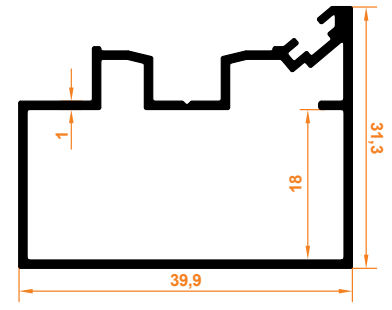

**Geniş Yan Dikme**  
Wide Side Column

Paket İçi Adet  
Quantity Per Package

6

824

0,583 kg/m

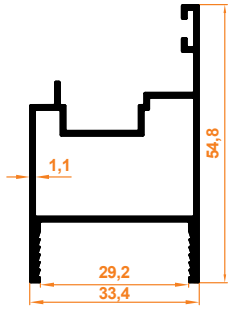

**Sabit Cam İspanyolet Profil**  
Fixed Glass Espagnolette Profile

Paket İçi Adet  
Quantity Per Package

6

825

0,356 kg/m

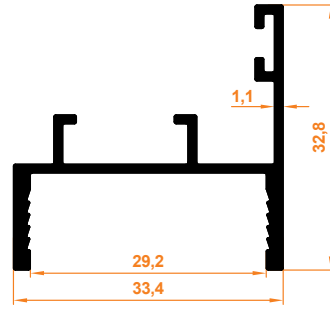

**Sabit Cam İspanyolet Karşılık Profil**  
Fixed Glass Espagnolette Handle Provision Profile

Paket İçi Adet  
Quantity Per Package

6

210

0,643 kg/m

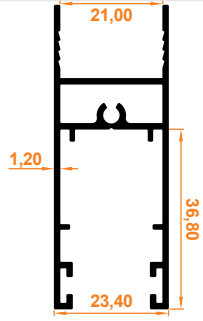

**Sürme Baza Profil**  
Sliding Base Profile

Paket İçi Adet  
Quantity Per Package

5

215

0,908 kg/m

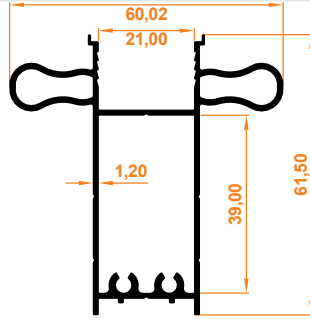

**Çekme Kol Profil**  
Pull Handle Profile

Paket İçi Adet  
Quantity Per Package

3

212

0,423 kg/m

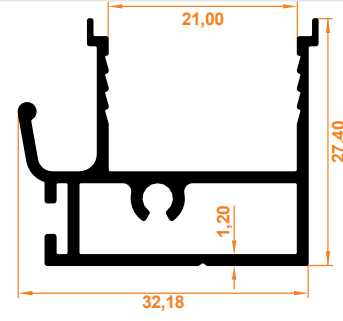

**Kenet Profil**  
Clamp Profile

Paket İçi Adet  
Quantity Per Package

6

211

0,301 kg/m

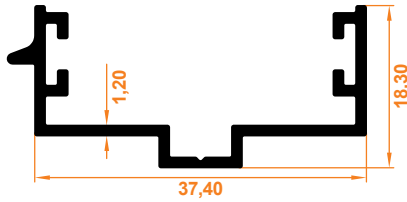

**Birleştirme Karşılık Profil**  
Combination Provisions Profile

Paket İçi Adet  
Quantity Per Package

6

213

0,974 kg/m

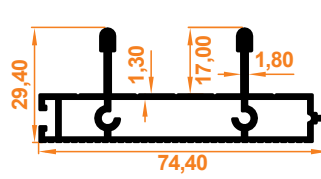

**İkili Eşikli Alt Kasa Profil**  
Double Threshold Lower Case Profile

Paket İçi Adet  
Quantity Per Package

4

222

1,333 kg/m

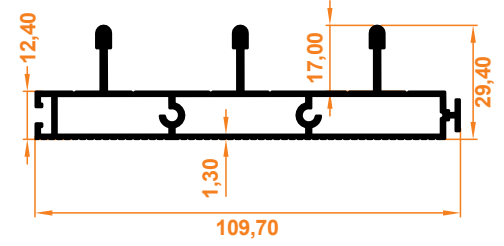

**Üçlü Eşikli Alt Kasa Profil**  
Triple Threshold Lower Case Profile

Paket İçi Adet  
Quantity Per Package

2

220

0,867 kg/m

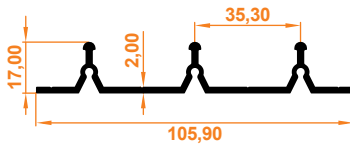

**Üçlü Eşiksiz Alt Kasa Profil**  
Triple Bottom Case Profile without Threshold

Paket İçi Adet  
Quantity Per Package

4

229

1,120 kg/m

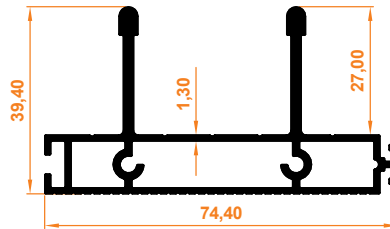

**İkili Üst Kasa Profil**  
Double Upper Case Profile

Paket İçi Adet  
Quantity Per Package

2

230

1,552 kg/m

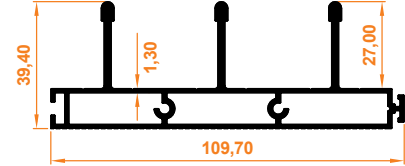

**İkili Üçlü Kasa Profil**  
Triple Upper Case Profile

Paket İçi Adet  
Quantity Per Package

2

221

1,156 kg/m

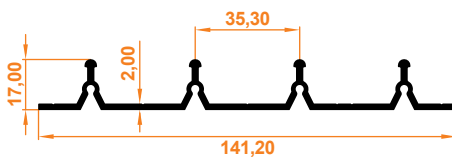

**Dörtlü Eşiksiz Alt Kasa Profil**  
Quadruple Bottom Case Profile without Threshold

Paket İçi Adet  
Quantity Per Package

2

214

0,587 kg/m

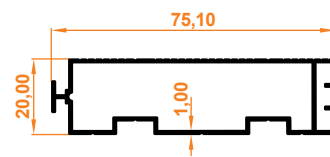

**İkili Yan Kasa Profil**  
Double Side Case Profile

Paket İçi Adet  
Quantity Per Package

4

223

0,792 kg/m

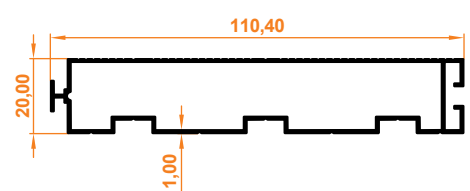

**Üçlü Yan Kasa Profil**  
Triple Side Case Profile

Paket İçi Adet  
Quantity Per Package

2

219

0,219 kg/m

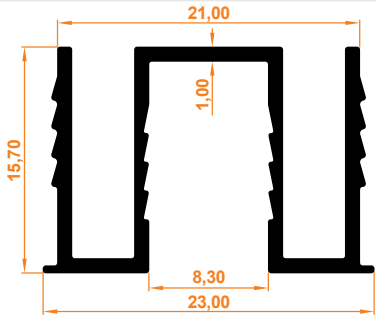

**8 mm Cam Adaptörü**  
8mm Glass Adapter

Paket İçi Adet  
Quantity Per Package

10

226

0,071 kg/m

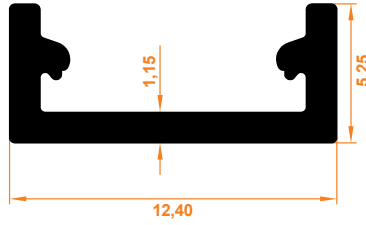

**Kapatma Profil**  
Closing Profile

Paket İçi Adet  
Quantity Per Package

20

227

0,751 kg/m

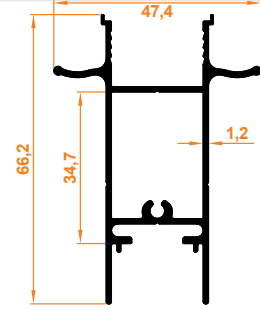

**İspanyolet Çekme Kol Profili**  
Espagnolette Pull Handle Profile

Paket İçi Adet  
Quantity Per Package

3

228

0,156 kg/m

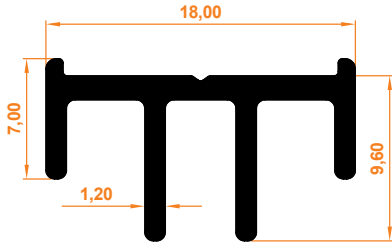

**İspanyolet Karşılık Profili**  
Espagnolette Provision Profile

Paket İçi Adet  
Quantity Per Package

10

## Sürme Sistem Çalışma Mekanizması

Sliding System Operating Mechanism

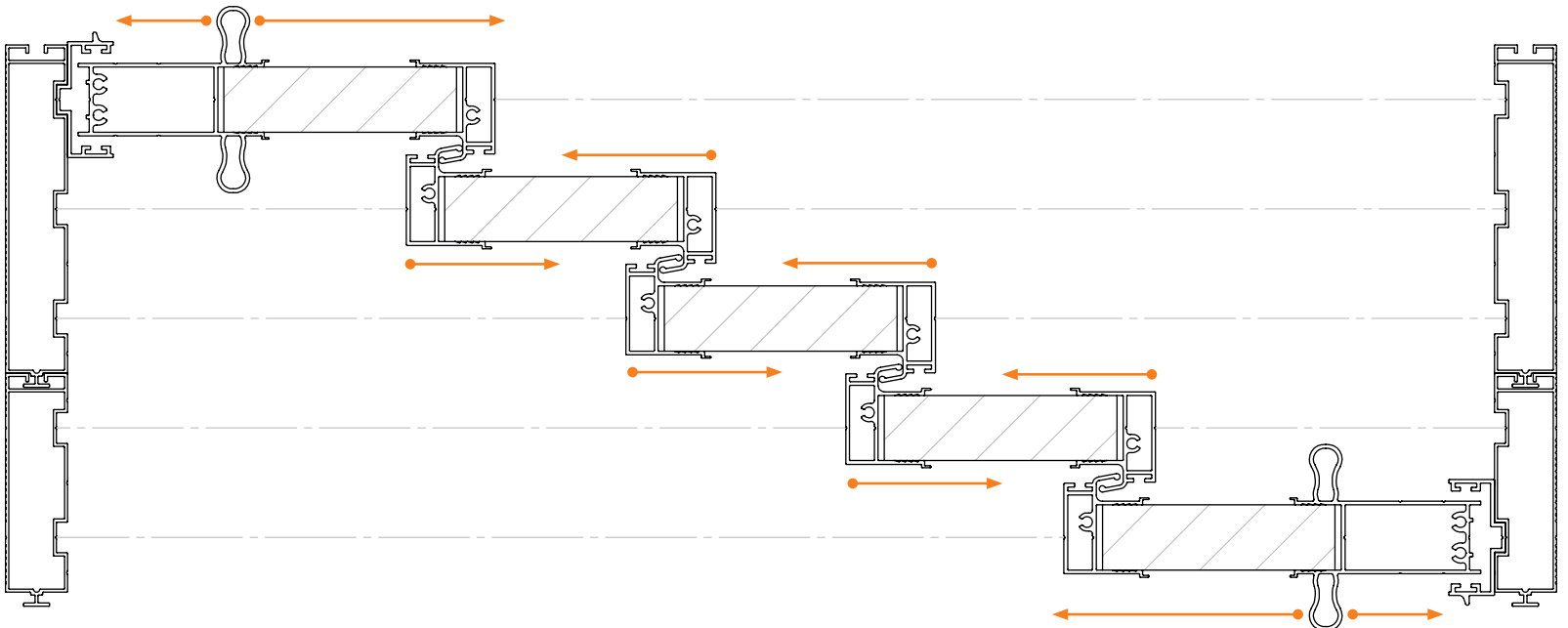

**Sürme Sistem Çalışma Mekanizması**

Sliding System Operating Mechanism

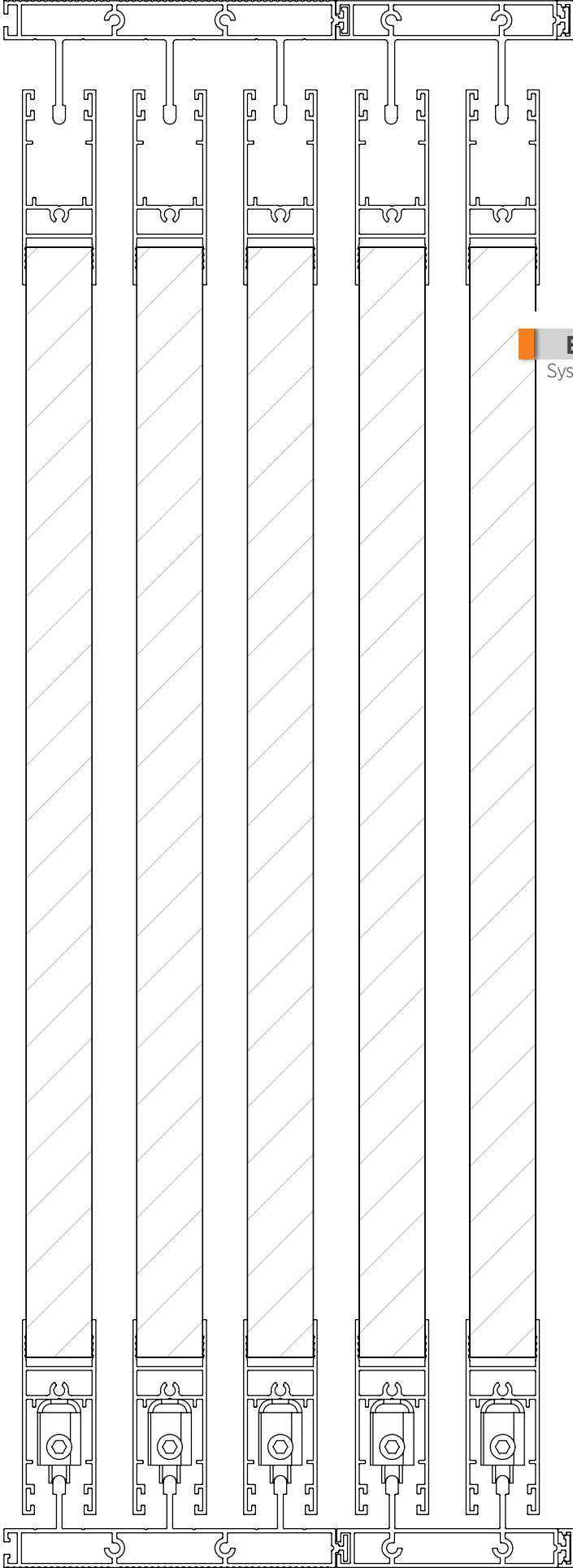

**Eşikli Sistem**

System with Treshold

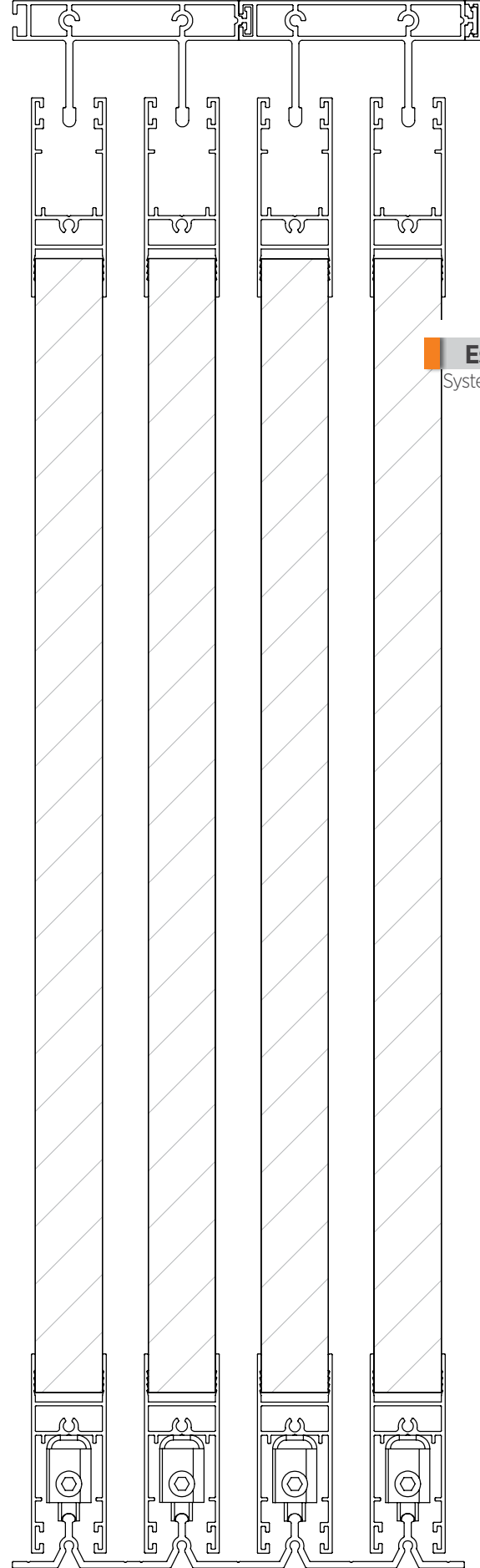

**Eşiksiz Sistem**

System without Treshold

140

0,563 kg/m

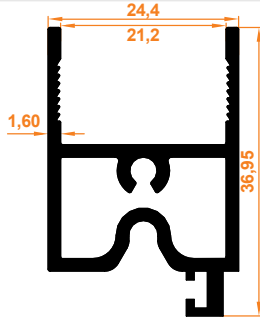

**Sabit Panel Açılır Alt Baza Profil**  
Fixed Panel Pop-up Base Profile

Paket İçi Adet  
Quantity Per Package | 6

164

0,842 kg/m

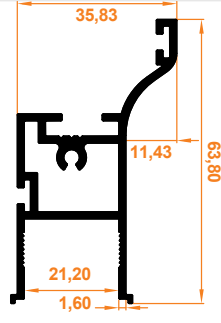

**Sabit Panel Yan Dikme Profil**  
Fixed Panel Side Column Profile

Paket İçi Adet  
Quantity Per Package | 4

142

0,750 kg/m

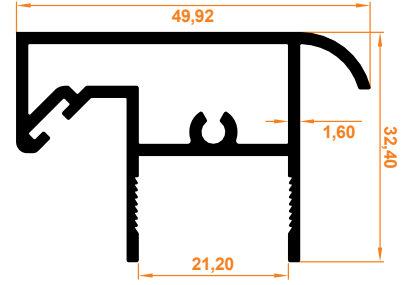

**Sabit Panel Üst Baza Profil**  
Fixed Panel Top Base Profile

Paket İçi Adet  
Quantity Per Package | 4

167

1,144 kg/m

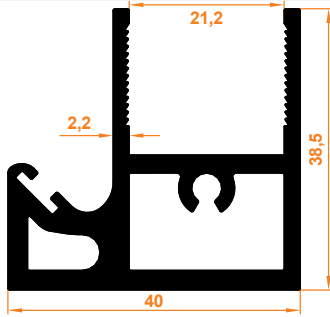

**Kenet Baza Profil**  
Clamp Base Profile

Paket İçi Adet  
Quantity Per Package | 4

144

0,434 kg/m

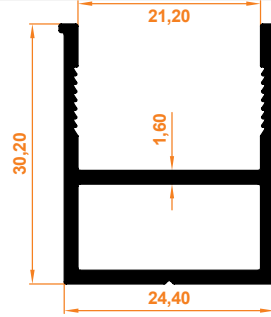

**Hareketli Panel Yan Dikme Profil**  
Movable Panel Side Column Profile

Paket İçi Adet  
Quantity Per Package | 6

145

0,579 kg/m

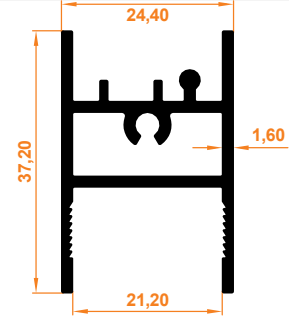

**Küpeşte Baza Profil**  
Handrail Base Profile

Paket İçi Adet  
Quantity Per Package | 6

146

0,741 kg/m

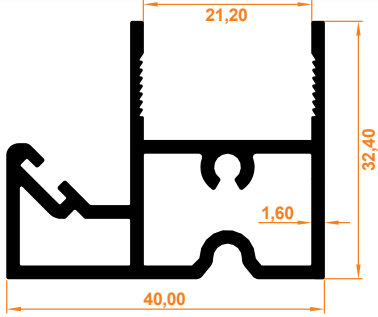

**Hareketli Panel Açılır Alt Baza Profil**  
Movable Panel Pop-up Lower Base Profile

Paket İçi Adet  
Quantity Per Package | 4

161

0,482 kg/m

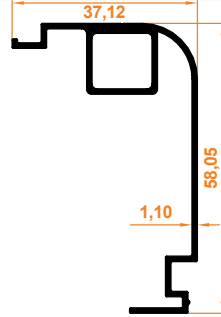

**Ray Kapatma "T" Profil**  
Rail Closure "T" Profile

Paket İçi Adet  
Quantity Per Package | 4

160

1,057 kg/m

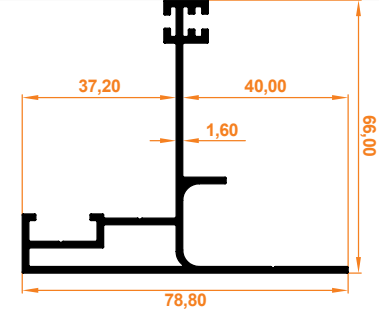

**Yan Ray "T" Profil**  
Side Rail "T" Profile

Paket İçi Adet  
Quantity Per Package | 2

166

0,144 kg/m



**Açılımlı için Ray Kapatma 'L' Profil**  
Rail Closure 'L' Profile for Opening

Paket İçi Adet  
Quantity Per Package | 10

162

0,703 kg/m

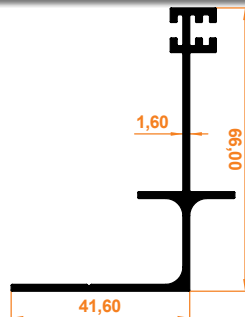

**Yan Ray "L" Profil**  
Side Rail "L" Profile

Paket İçi Adet  
Quantity Per Package | 4

GYT 28

2,110 kg/m

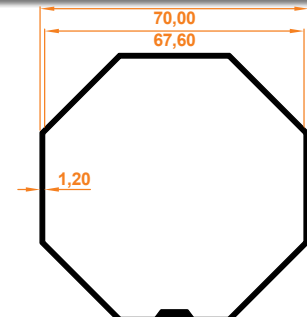

**Sac Tambur Borusu**  
Sheet Drum Pipe

Paket İçi Adet  
Quantity Per Package | 1

152

1,563 kg/m

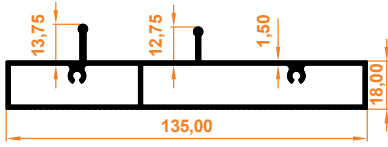

**Alt Kasa**  
Guillotine Lower Case Profile

Paket İçi Adet | 2  
Quantity Per Package

156

3,449 kg/m

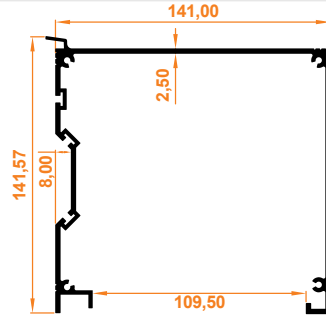

**Üst Kasa Profil**  
Top Case Profile

Paket İçi Adet | 1  
Quantity Per Package

153

0,864 kg/m



**Üst Kasa Kapak Profil**  
Top Case Cover Profile

Paket İçi Adet | 2  
Quantity Per Package

155

1,669 kg/m

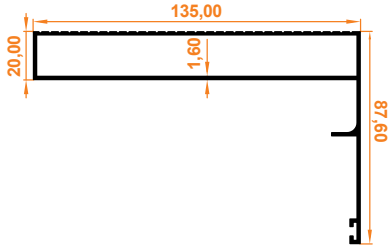

**Yan Kasa Profil**  
Side Case Profile

Paket İçi Adet | 2  
Quantity Per Package

154

0,759 kg/m

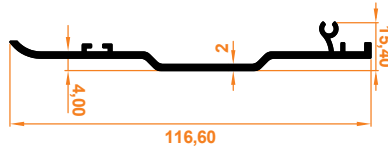

**Küpeşte Profil**  
Handrail Profile

Paket İçi Adet | 2  
Quantity Per Package

165

0,644 kg/m



**Yan Kasa Kertme Profil**  
Side Case Notched Profile

Paket İçi Adet | 4  
Quantity Per Package

158

0,510 kg/m

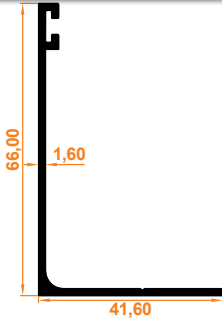

**Açılımsız Tek Fıtil Yan Ray L Kasa Profil**  
Single Weatherstrips Without Opening Side L Case Profile

Paket İçi Adet | 4  
Quantity Per Package

159

0,660 kg/m

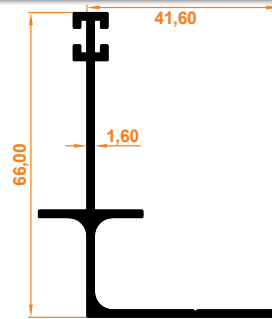

**Açılımsız Çift Fıtil Yan Ray L Kasa Profil**  
Double Weatherstrips Without Opening Side L Case Profil

Paket İçi Adet | 4  
Quantity Per Package

219

0,219 kg/m

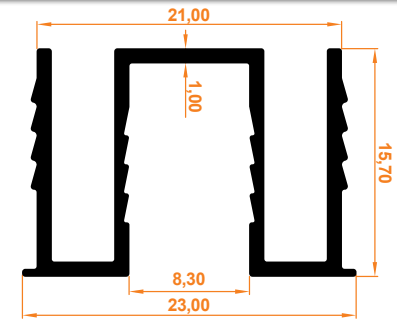

**8 mm Cam Adaptörü**  
8mm Glass Adapter

Paket İçi Adet | 10  
Quantity Per Package

149

0,162 kg/m

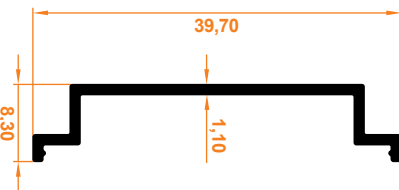

**Açılımsız için Ray Kapatma 'L' Profil**  
Rail Closure 'L' Profile for Non-Opening

Paket İçi Adet | 10  
Quantity Per Package



## Giyotin Sistem Çalışma Mekanizması

Guillotine System Operating Mechanism

1. Kademe - Level 1

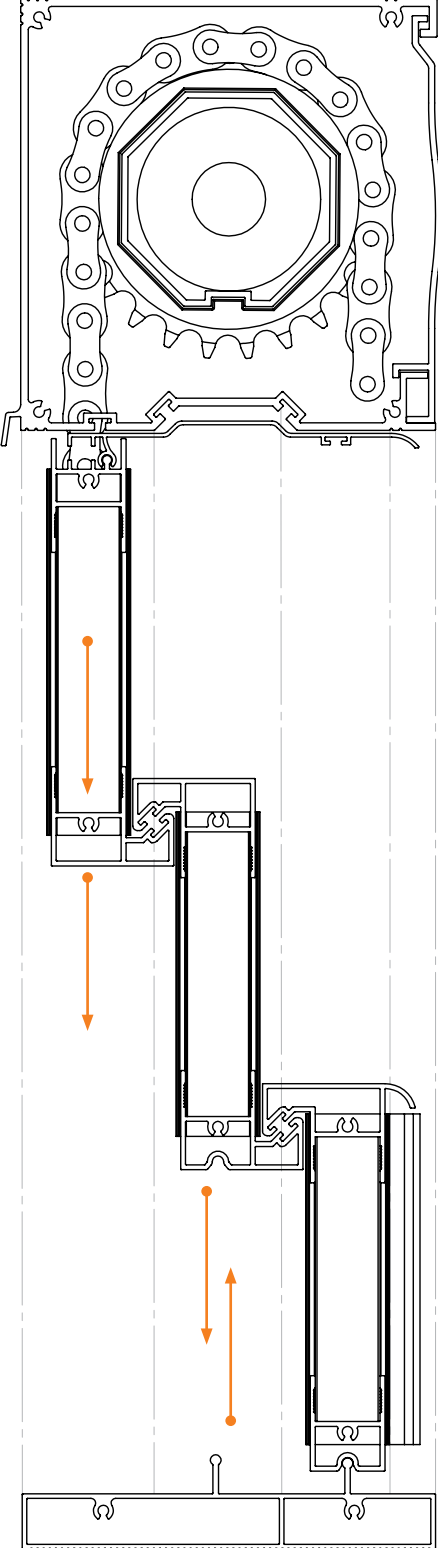

2. Kademe - Level 2

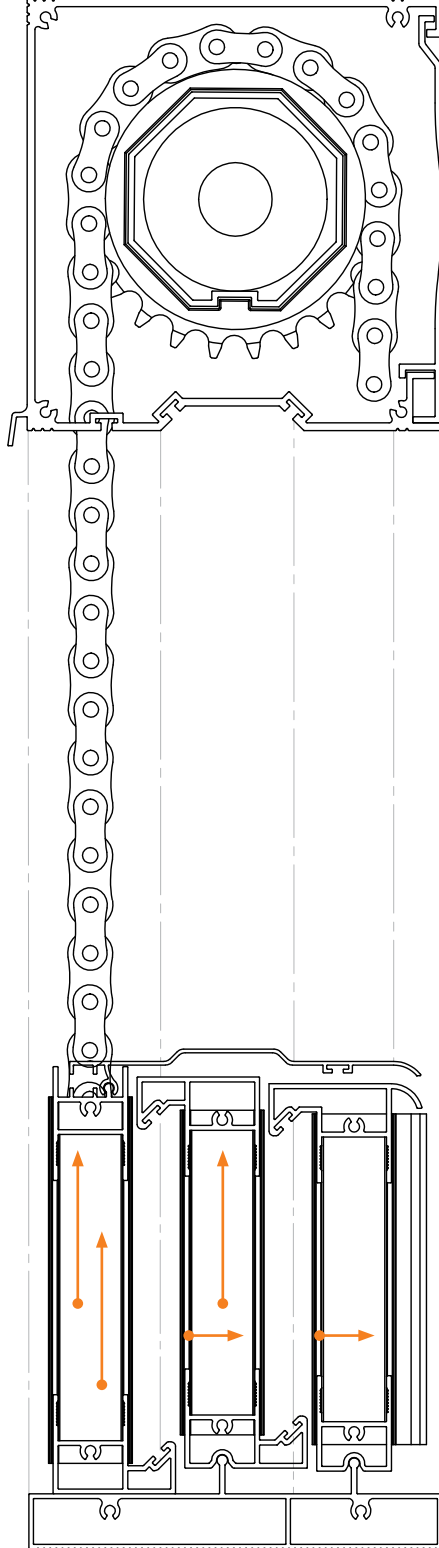

3. Kademe - Level 3

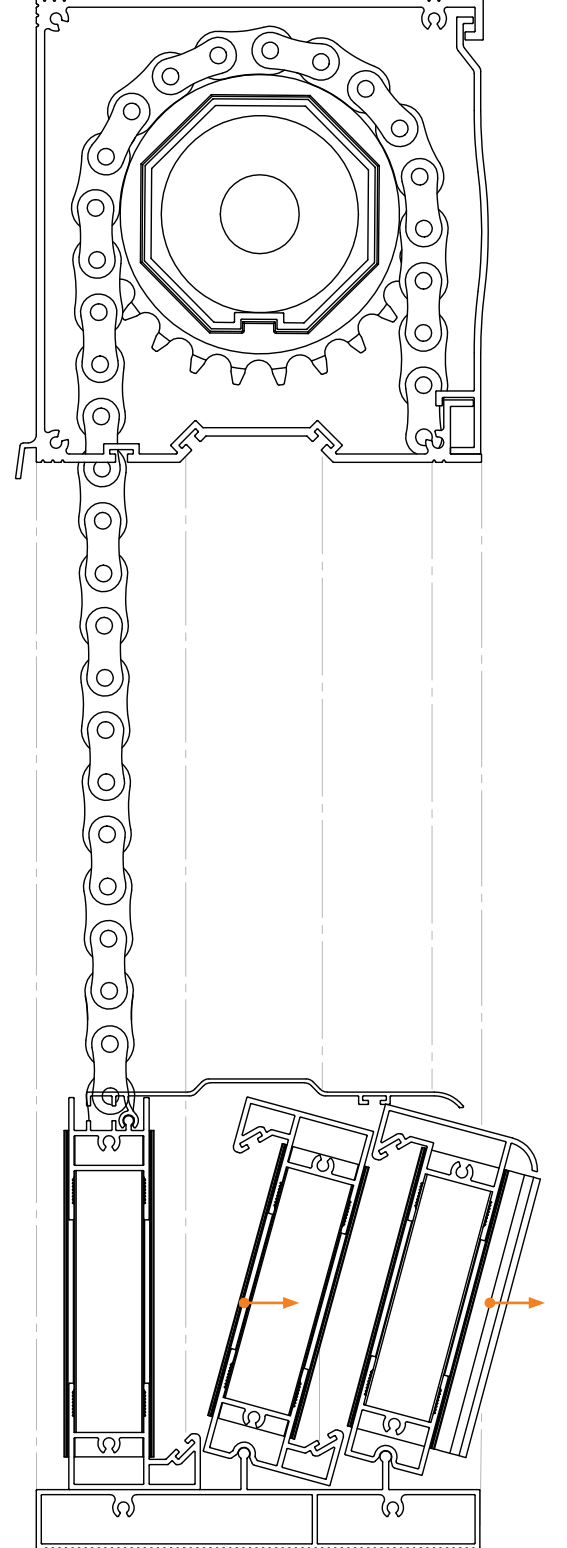

417

0,467 kg/m

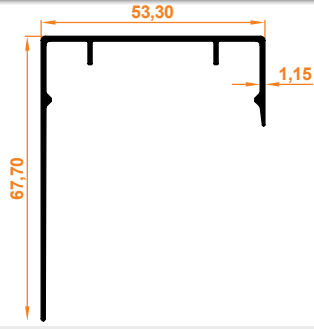

**Sonlandırıcı Cam Çita Kapak Profili**  
End Cap Glass Strip Cover Profile

Paket İçi Adet | 4  
Quantity Per Package

418

0,329 kg/m

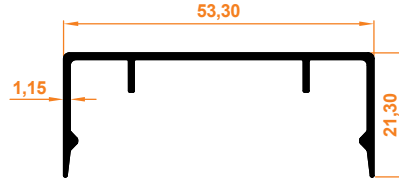

**Cam Çita Kapak Profili**  
Glass Strip Cover Profile

Paket İçi Adet | 10  
Quantity Per Package

419

2,100 kg/m

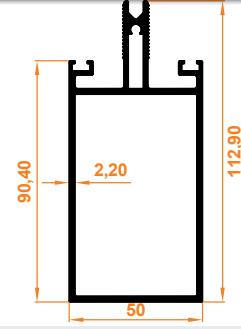

**Orta Kayıt Profili**  
Center Mullion Profile

Paket İçi Adet | 2  
Quantity Per Package

420

0,682 kg/m

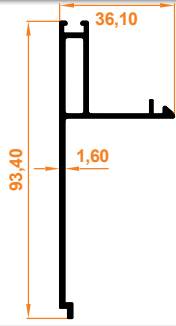

**Kasa Kapatma Profili**  
Frame Closure Profile

Paket İçi Adet | 2  
Quantity Per Package

421

3,184 kg/m

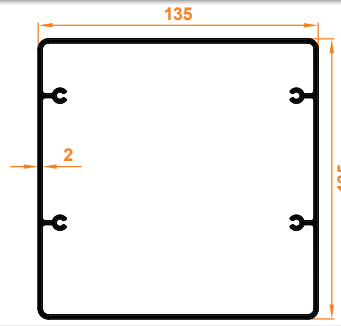

**Ayak Profili**  
Leg Profile

Paket İçi Adet | 1  
Quantity Per Package

422

4,318 kg/m

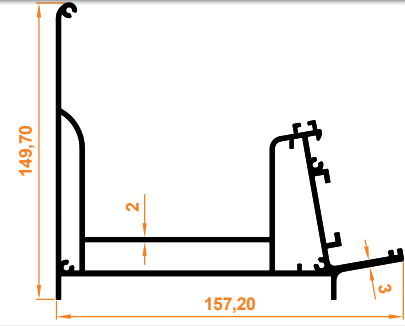

**Oluk Profili**  
Groove Profile

Paket İçi Adet | 1  
Quantity Per Package

423

3,142 kg/m

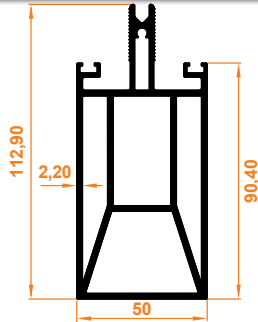

**Destekli Orta Kayıt Profili**  
Reinforced Center Mullion Profile

Paket İçi Adet | 2  
Quantity Per Package

424

2,835 kg/m

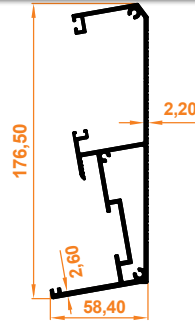

**Duvar Kasa Profili**  
Wall Frame Profile

Paket İçi Adet | 1  
Quantity Per Package

426

3,434 kg/m

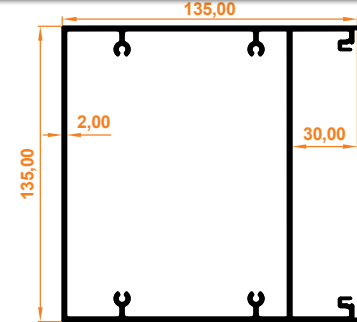

**Gizli Ayak Profili**  
Hidden Leg Profile

Paket İçi Adet | 1  
Quantity Per Package

427

2,271 kg/m

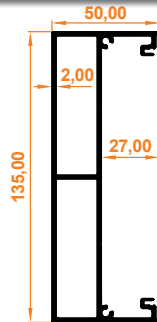

**Destek Kutu Profili**  
Reinforcing Box Profile

Paket İçi Adet | 2  
Quantity Per Package

428

0,501 kg/m



**Gizli Ayak ve Destek Kutu Kapatma Profili**  
Hidden Leg Case Cover Support Profile

Paket İçi Adet | 10  
Quantity Per Package

429

0,578 kg/m

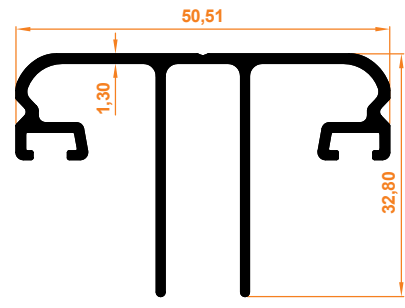

**Cam Çita Profili**  
Glass Strip Profile

Paket İçi Adet | 2  
Quantity Per Package

430

2,252 kg/m

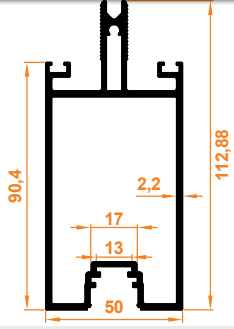

**Ledli Orta Kayıt Profili**  
Center Mullion Profile with Led

Paket İçi Adet  
Quantity Per Package

2

431

0,079 kg/m

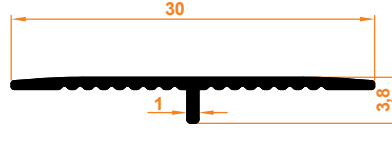

**T Profili**  
T Profile

Paket İçi Adet  
Quantity Per Package

10

7100

0,921 kg/m

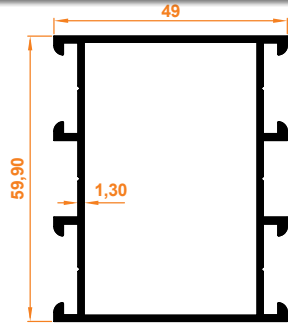

**C60 Kasa Orta Kayıt Profili**  
C60 Case Mid Entry Profile

Paket İçi Adet  
Quantity Per Package

4

7101

0,988 kg/m

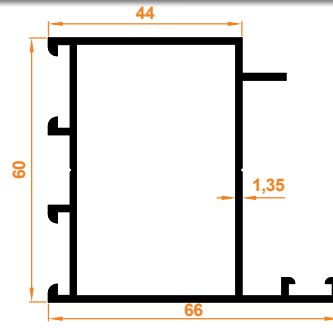

**C60 Kanat Profili**  
C60 Wing Profile

Paket İçi Adet  
Quantity Per Package

4

7102

1,440 kg/m

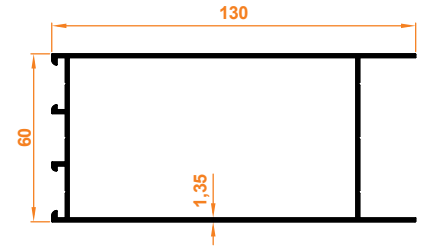

**C60 Etek Profili**  
C60 Skirt Profile

Paket İçi Adet  
Quantity Per Package

2

7103

1,099 kg/m

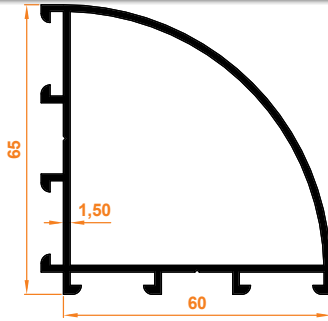

**C60 Oval Köşe Dönüş Profili**  
C60 Oval Corner Profile

Paket İçi Adet  
Quantity Per Package

2

7104

0,436 kg/m

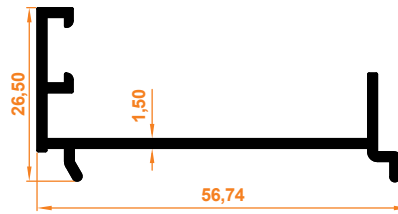

**C60 Kanat Adaptörü Profili**  
C60 Wing Adapter Profile

Paket İçi Adet  
Quantity Per Package

8

7105

1,155 kg/m

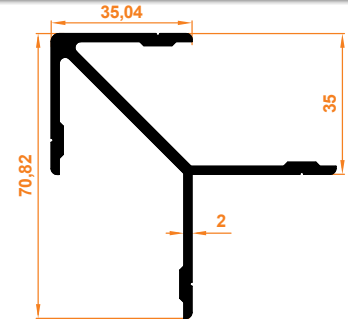

**C60 Köşe Takozu**  
C60 Corner Wedge

Paket İçi Adet  
Quantity Per Package

3

7106

0,467 kg/m

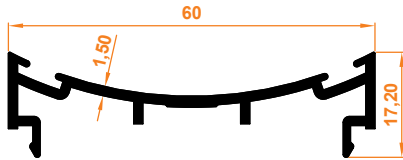

**C60 Çarpma Kapı Adaptörü - Dişi**  
C60 Crash Door Adapter - Female

Paket İçi Adet  
Quantity Per Package

8

7107

0,367 kg/m



**C60 Çarpma Kapı Adaptörü - Erkek**  
C60 Crash Door Adapter - Male

Paket İçi Adet  
Quantity Per Package

8

7108

0,241 kg/m

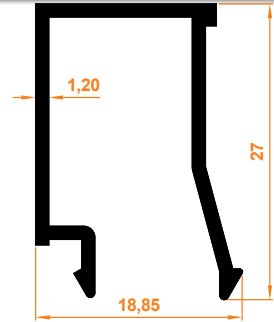

**C60 Isıcam Çıta Profili**  
C60 Insulating Glass Stave Profile

Paket İçi Adet  
Quantity Per Package

24

7109

0,234 kg/m

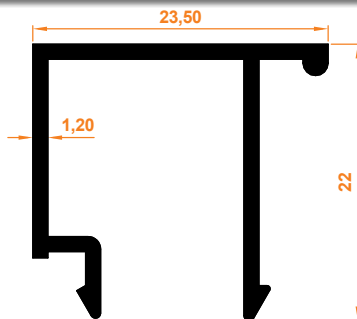

**C60 Tek Cam Çıta Profili**  
C60 Single Glass Stave Profile

Paket İçi Adet  
Quantity Per Package

24

# ALDOKS SERİ ALÜMİNYUM PROFİL GRUBU

Aldoks Series Aluminum Profile Group

7000

0,473 kg/m

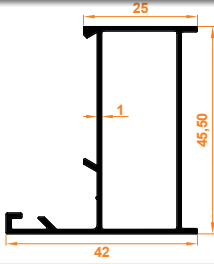

**Aldoks (Dar) Kasa Profili**  
Aldoks (Tight) Frame Profile

Paket İçi Adet  
Quantity Per Package

6

7003

0,891 kg/m

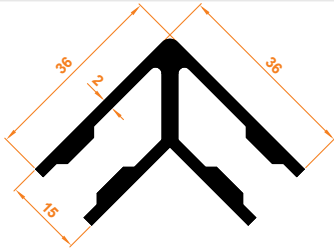

**Aldoks (Dar) Köşe Takozu**  
Aldoks (Tight) Corner Wedge

Paket İçi Adet  
Quantity Per Package

3

7006

0,659 kg/m

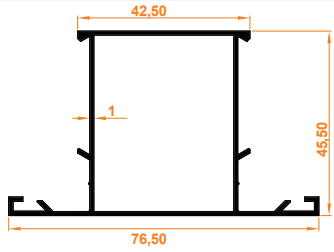

**Aldoks (Orta) Kayıt Profili**  
Aldoks (Mid) Entry Profile

Paket İçi Adet  
Quantity Per Package

3

7009

0,719 kg/m

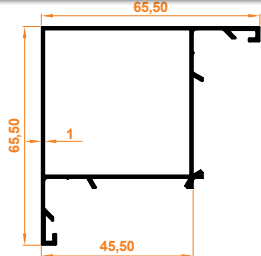

**Aldoks Köşe Dönüş Profili**  
Aldoks Corner Profile

Paket İçi Adet  
Quantity Per Package

2

7012

1,149 kg/m

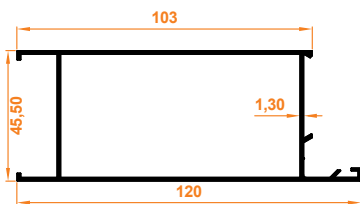

**Aldoks Etek Profili**  
Aldoks Skirt Profile

Paket İçi Adet  
Quantity Per Package

2

7001

0,565 kg/m

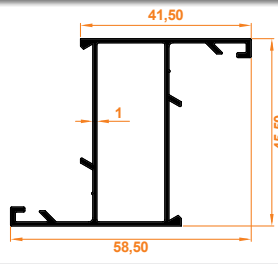

**Aldoks (Dar) Kanat Profili**  
Aldoks (Tight) Wing Profile

Paket İçi Adet  
Quantity Per Package

4

7004

0,565 kg/m

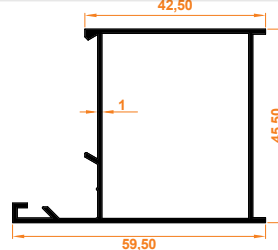

**Aldoks (Orta) Kasa Profili**  
Aldoks (Mid) Frame Profile

Paket İçi Adet  
Quantity Per Package

6

7007

1,136 kg/m

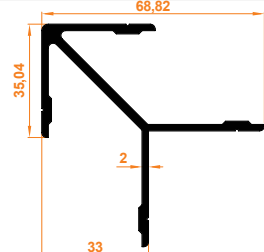

**Aldoks (Orta) Köşe Takozu**  
Aldoks (Mid) Corner Wedge

Paket İçi Adet  
Quantity Per Package

3

7010

1,028 kg/m

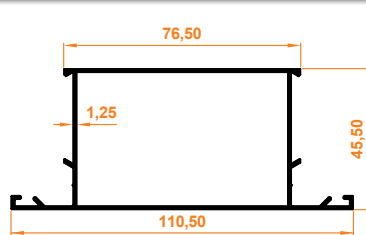

**Aldoks (Geniş) Orta Kayıt Profili**  
Aldoks (Wide) Mid Entry Profile

Paket İçi Adet  
Quantity Per Package

2

7013

0,215 kg/m

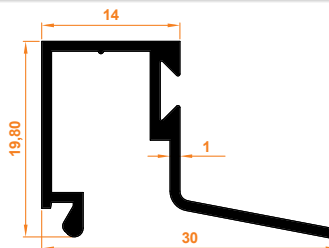

**Aldoks Isıcam Çita**  
Aldoks Double Glazing Stave

Paket İçi Adet  
Quantity Per Package

10

7002

0,565 kg/m

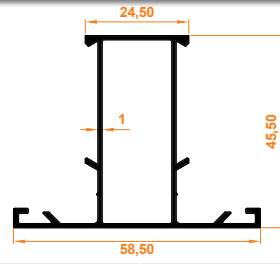

**Aldoks (Dar) Orta Kayıt Profili**  
Aldoks (Tight) Mid Entry Profile

Paket İçi Adet  
Quantity Per Package

4

7005

0,659 kg/m

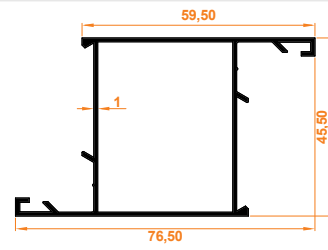

**Aldoks (Orta) Kanat Profili**  
Aldoks (Mid) Wing Profile

Paket İçi Adet  
Quantity Per Package

3

7008

0,695 kg/m

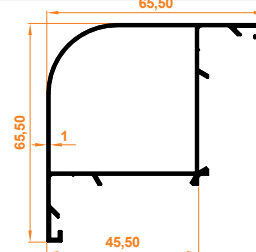

**Aldoks Oval Köşe Dönüş Profili**  
Aldoks Oval Corner Profile

Paket İçi Adet  
Quantity Per Package

2

7011

1,028 kg/m

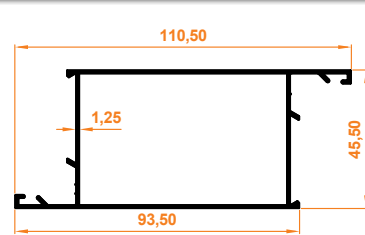

**Aldoks (Geniş) Kanat Profili**  
Aldoks (Wide) Wing Profile

Paket İçi Adet  
Quantity Per Package

2

7014

0,213 kg/m

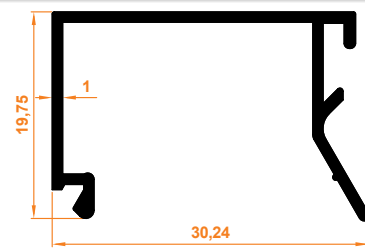

**Aldoks Tek Cam Çita**  
Aldoks Single Glass Stave

Paket İçi Adet  
Quantity Per Package

16

900

0,685 kg/m

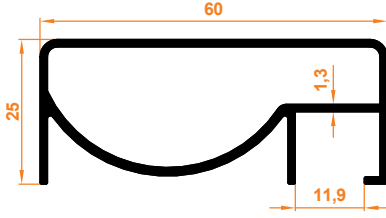

**60x25 mm Üst Küpeşte Yandan Kanallı**  
60x25 mm Upper Handrail with Side Channel

Paket İçi Adet | 4  
Quantity Per Package

901

0,230 kg/m

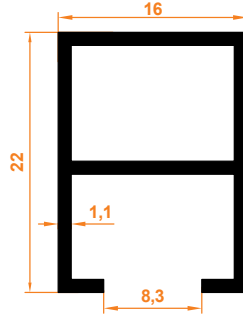

**Cam Tutucu**  
Glass Holder

Paket İçi Adet | 10  
Quantity Per Package

902

0,848 kg/m

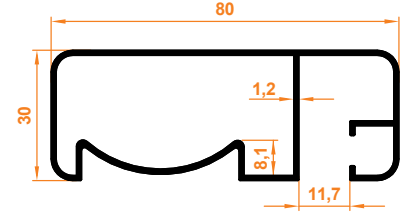

**80x30 Yandan Kanallı**  
80x30 Side Channel

Paket İçi Adet | 4  
Quantity Per Package

903

0,785 kg/m

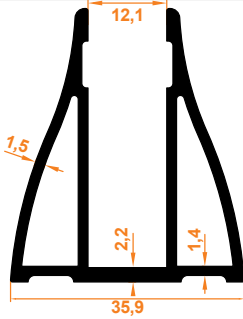

**Cam Alt Baza**  
Glass Bottom Base

Paket İçi Adet | 3  
Quantity Per Package

904

0,159 kg/m

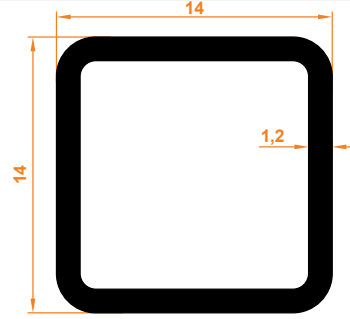

**14x14 Emniyet Şeridi**  
14x14 Safety Strip

Paket İçi Adet | 20  
Quantity Per Package

905

0,060 kg/m

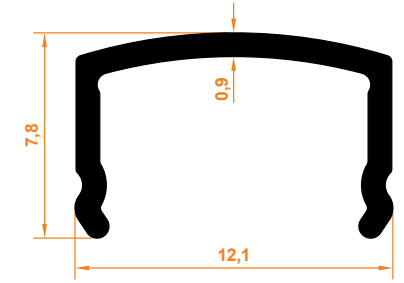

**Boru Çıtası**  
Pipe Lath

Paket İçi Adet | 20  
Quantity Per Package

906

0,650 kg/m

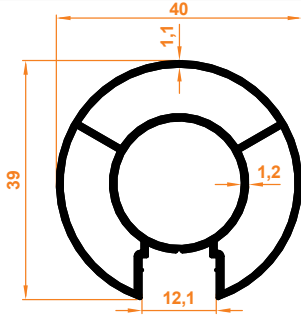

**40x1,1 mm Tek Kanallı Çiftli Dikme**  
40x1,1 mm Single Channel Double Column

Paket İçi Adet | 5  
Quantity Per Package

907

0,532 kg/m

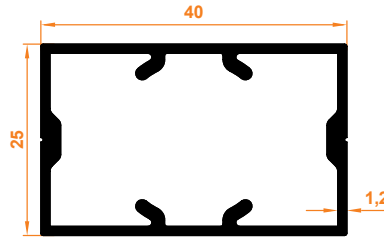

**40x25 Dikme**  
40x25 Column

Paket İçi Adet | 10  
Quantity Per Package

908

0,922 kg/m

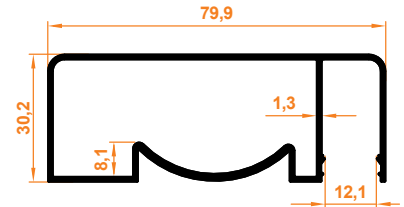

**80x30 Yandan Kanallı**  
80x30 Side Channel

Paket İçi Adet | 4  
Quantity Per Package

909

0,717 kg/m

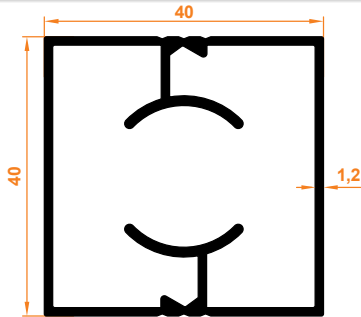

**40x40 Kanalsız Dikme**  
40x40 Non Channel Column

Paket İçi Adet | 3  
Quantity Per Package

910

0,631 kg/m

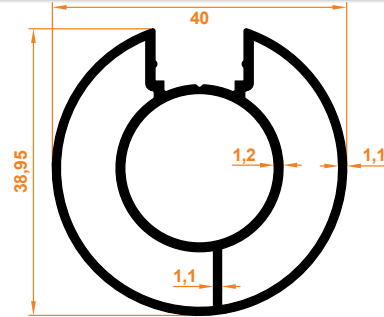

**40x1,1 mm Tek Kanallı Tekli Dikme**  
40x1,1 mm Single Channel Single Column

Paket İçi Adet | 5  
Quantity Per Package

911

0,840 kg/m

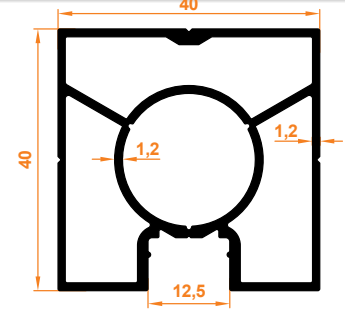

**40x40 Tek Kanallı Dikme**  
40x40 Single Channel Column

Paket İçi Adet | 3  
Quantity Per Package

912

0,641 kg/m

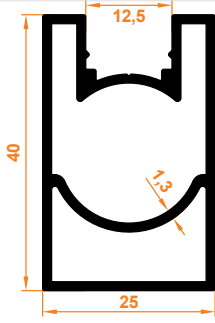

**40x25 Tek Kanallı**  
40x25 Single Slot

Paket İçi Adet  
Quantity Per Package

10

913

0,064 kg/m

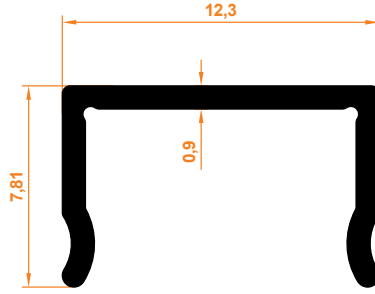

**Kare Çıta**  
Square Slat

Paket İçi Adet  
Quantity Per Package

20

914

0,082 kg/m

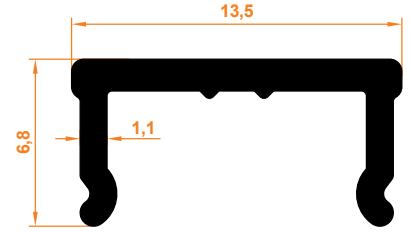

**80x30 Yandan Kanallı Çıtası**  
80x30 Side Slot Rail

Paket İçi Adet  
Quantity Per Package

20

915

0,778 kg/m

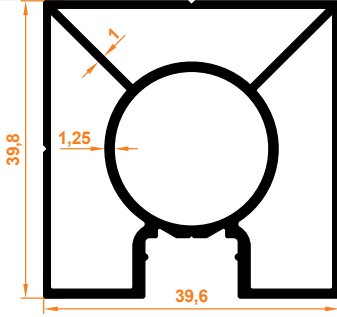

**40x40 Tek Kanallı Dikme**  
40x40 Single Slot Column

Paket İçi Adet  
Quantity Per Package

3

916

0,627 kg/m

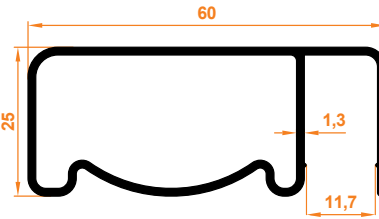

**60x25 Yandan Kanallı**  
60x25 Side Slot

Paket İçi Adet  
Quantity Per Package

4

918

0,256 kg/m

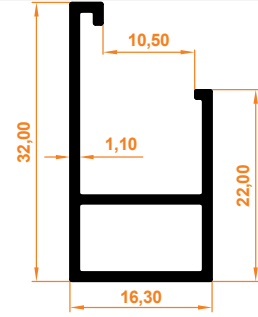

**8-10 mm Cam Altı Profil**  
8-10 mm Glass Bottom

Paket İçi Adet  
Quantity Per Package

10

919

0,807 kg/m

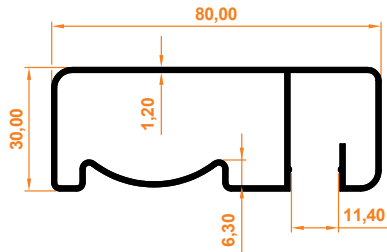

**80x30 Yandan Kanallı**  
80x30 Side Slot

Paket İçi Adet  
Quantity Per Package

4

923

0,326 kg/m

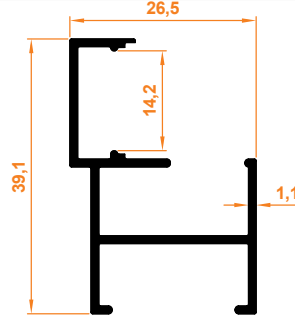

**Cam Tutucu Profil**  
Glass Holder Profile

Paket İçi Adet  
Quantity Per Package

10

924

0,082 kg/m

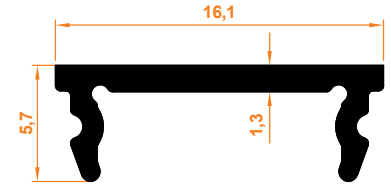

**Takviyesiz Cam Tutucu Çıta Profil**  
Non-Reinforced Glass Holder Lath Profile

Paket İçi Adet  
Quantity Per Package

20

925

0,396 kg/m

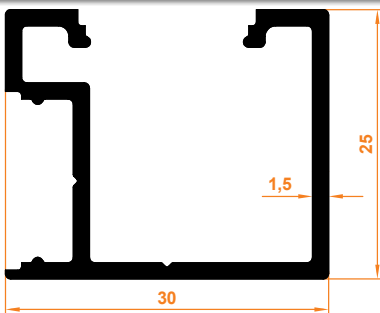

**Takviyesiz Cam Tutucu Profil**  
Non-Reinforced Glass Holder Profile

Paket İçi Adet  
Quantity Per Package

6

926

0,501 kg/m

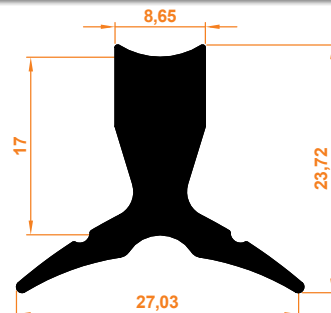

**Y Bağlantı Profil**  
Y-Connector Profile

Paket İçi Adet  
Quantity Per Package

8

927

0,478 kg/m

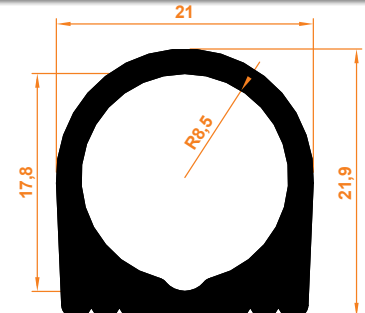

**Boru Tutamak Profil**  
Tube Grip Profile

Paket İçi Adet  
Quantity Per Package

8

700

0,185 kg/m

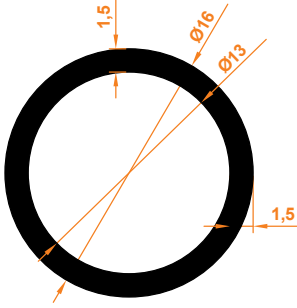

16x1,5 Boru

16x1,5 Pipe

Paket İçi Adet  
Quantity Per Package

12

701

0,538 kg/m

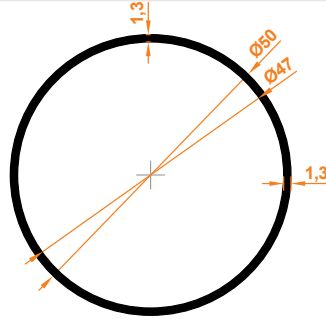

50x1,3 Boru

50x1,3 Pipe

Paket İçi Adet  
Quantity Per Package

3

702

0,509 kg/m

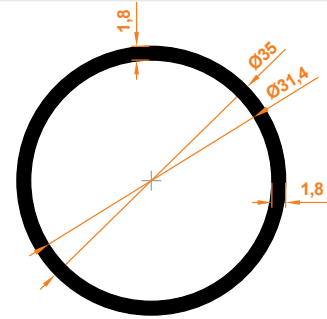

35x1,8 Boru

35x1,8 Pipe

Paket İçi Adet  
Quantity Per Package

5

703

0,182 kg/m

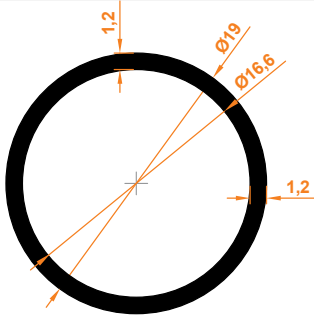

19x1,2 Boru

19x1,2 Pipe

Paket İçi Adet  
Quantity Per Package

12

704

0,162 kg/m

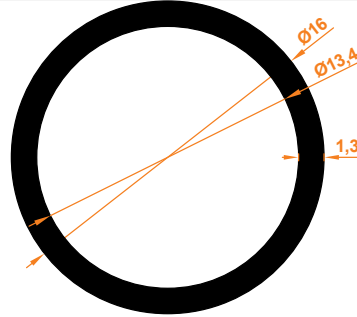

16x1,3 Boru

16x1,3 Pipe

Paket İçi Adet  
Quantity Per Package

12

**AHŞAP JALUZİ PROFİL GRUBU**  
Wooden Venetian Blind Profile Group

30

0,600 kg/m

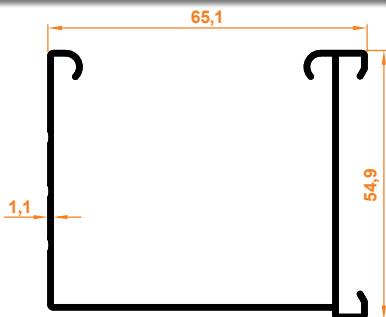

Ahşap Jaluzi Perde Kasa Profil

Venetian Blind Headrail Profile

Paket İçi Adet  
Quantity Per Package

6

1003

0,253 kg/m

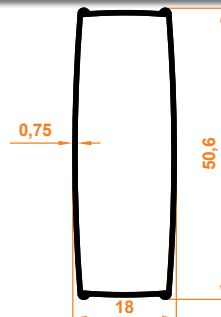

Ahşap Jaluzi Perde Etek Profil

Venetian Blind Bottomrail Profile

Paket İçi Adet  
Quantity Per Package

6



# ZIP PERDE PROFİL GRUBU

Zip Blinds Profile Group

250

1,288 kg/m

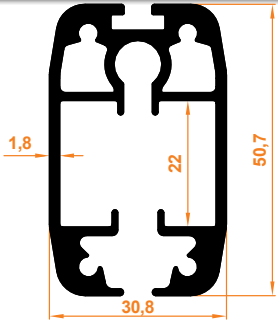

**Kanat Profili**  
Wing Profile

Paket İçi Adet  
Quantity Per Package

2

251

0,572 kg/m

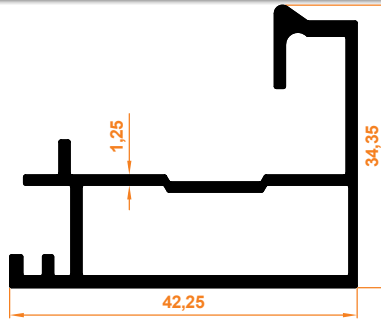

**Yan Kasa Profili**  
Side Case Profile

Paket İçi Adet  
Quantity Per Package

6

252

0,313 kg/m

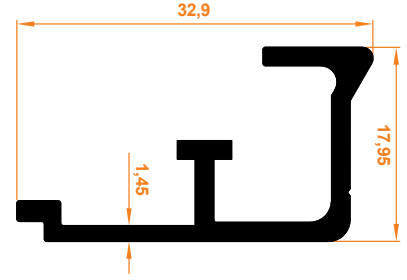

**Yan Kasa Kapak Profili**  
Side Case Cover Profile

Paket İçi Adet  
Quantity Per Package

10

7150

1,776 kg/m

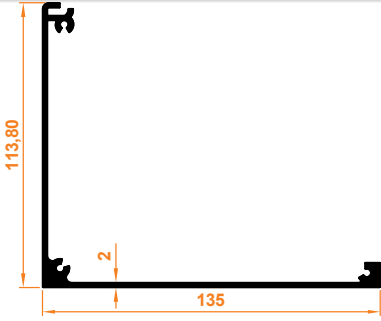

**Üst Kasa Profili**  
Upper Case Profile

Paket İçi Adet  
Quantity Per Package

2

7151

1,475 kg/m

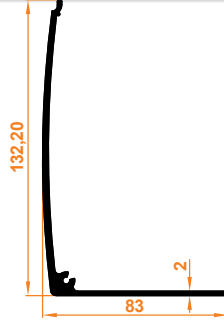

**Üst Kasa Kapak Profili**  
Upper Case Cover Profile

Paket İçi Adet  
Quantity Per Package

2

ZP 13

2,110 kg/m

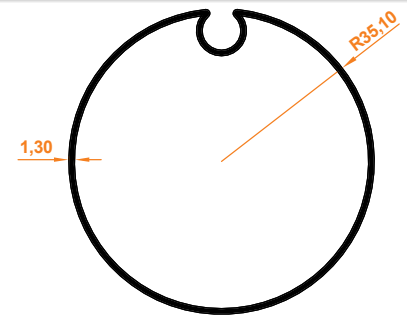

**Sac Tambur Borusu**  
Sheet Drum Tube

Paket İçi Adet  
Quantity Per Package

1

ZP 15

0,800 kg/m



**5x20 Lama Demir**  
5x20 Blade Iron

Paket İçi Adet  
Quantity Per Package

1

362

0,167 kg/m

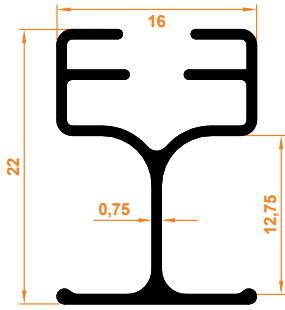

**T Profil**  
T Profile

Paket İçi Adet  
Quantity Per Package

10

334

0,265 kg/m

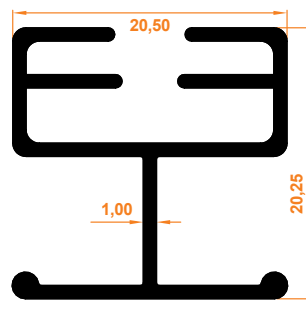

**20'lik T Profil**  
20 T Profile

Paket İçi Adet  
Quantity Per Package

10

339

0,102 kg/m

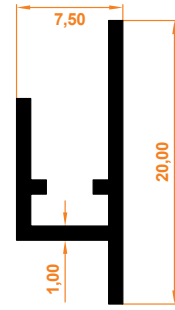

**Yaylı Yapışkan Profil**  
Spring Adhesive Profile

Paket İçi Adet  
Quantity Per Package

10

332

0,094 kg/m

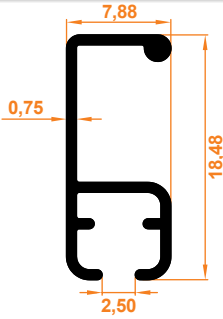

**Small T Profil**  
Small T Profile

Paket İçi Adet  
Quantity Per Package

10

340

0,076 kg/m

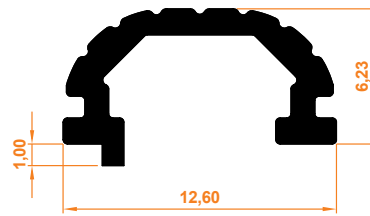

**Yaylı Portray Profil**  
Spring Portray Profile

Paket İçi Adet  
Quantity Per Package

10

327

0,252 kg/m

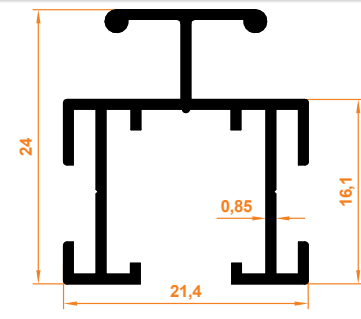

**Çiftli Orta Profil**  
Double Middle Profile

Paket İçi Adet  
Quantity Per Package

10

330

0,105 kg/m



**Portray Yapışkan Profil**  
Adhesive Profile

Paket İçi Adet  
Quantity Per Package

10

357

0,162 kg/m

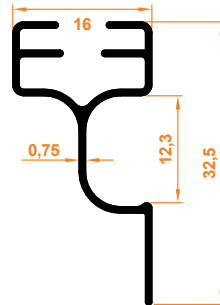

**Etekli T Profil**  
Extended T Profile

Paket İçi Adet  
Quantity Per Package

10

20

0,203 kg/m

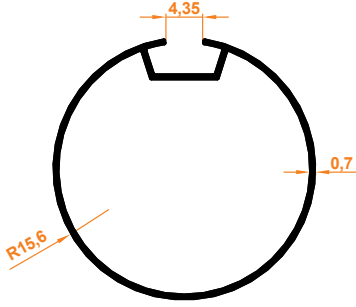

**32'lik Boru**  
Ø32 Roller Tube

Paket İçi Adet  
Quantity Per Package

10

21

0,420 kg/m

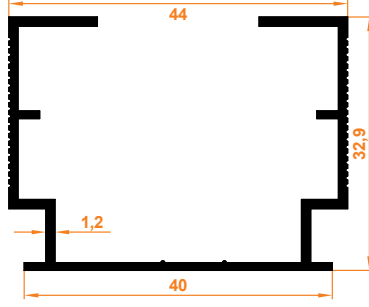

**Dikey Geniş Kasa**  
Vertical Wide Headbox

Paket İçi Adet  
Quantity Per Package

10

23

0,185 kg/m

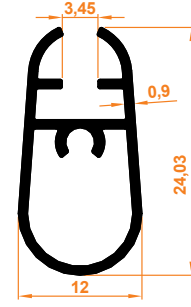

**Minyatür Lama**  
Mini Flat Bar

Paket İçi Adet  
Quantity Per Package

10

24

0,188 kg/m

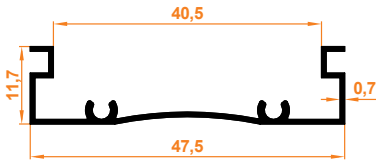

**Stor Perde Kasa Tırnaksız**  
Toothless Headbox for Roller Blinds

Paket İçi Adet  
Quantity Per Package

10

25

0,240 kg/m

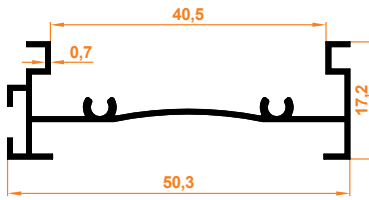

**Zebra Açık Kasa**  
Open Cassette for Zebra Blinds

Paket İçi Adet  
Quantity Per Package

10

26

0,106 kg/m

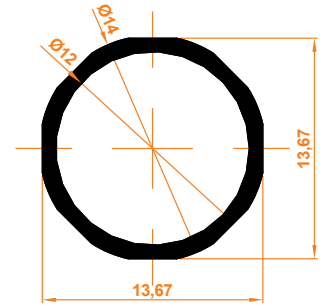

**Zebra Mil**  
Zebra Blind Shaft

Paket İçi Adet  
Quantity Per Package

10

27

0,362 kg/m

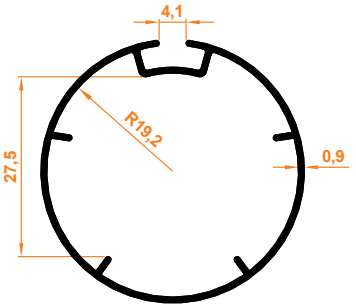

**Zebra Perde Borusu**  
Zebra Blind Tube

Paket İçi Adet  
Quantity Per Package

7

28

0,549 kg/m

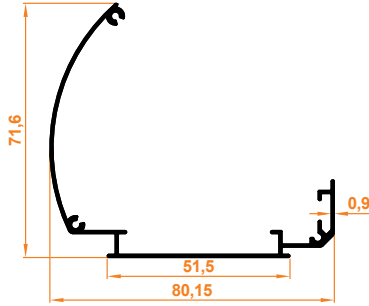

**Zebra Perde Kapalı Kasa**  
Closed Cassette for Zebra Blinds

Paket İçi Adet  
Quantity Per Package

6

29

0,060 kg/m

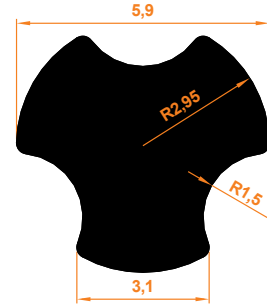

**Zebra Dikey Mil**  
Vertical Shaft for Zebra Blinds

Paket İçi Adet  
Quantity Per Package

25

200

0,136 kg/m

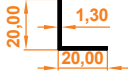

**20x20 Köşebent**  
20x20 Angle Bracket

Paket İçi Adet | 15  
Quantity Per Package

201

0,207 kg/m

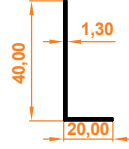

**20x40 Köşebent**  
20x40 Angle Bracket

Paket İçi Adet | 15  
Quantity Per Package

202

0,277 kg/m

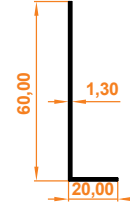

**20x60 Köşebent**  
20x60 Angle Bracket

Paket İçi Adet | 10  
Quantity Per Package

204

0,347 kg/m

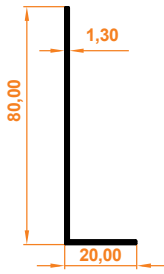

**20x80 Köşebent**  
20x80 Angle Bracket

Paket İçi Adet | 10  
Quantity Per Package

203

0,418 kg/m

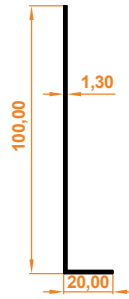

**20x100 Köşebent**  
20x100 Angle Bracket

Paket İçi Adet | 5  
Quantity Per Package

205

0,488 kg/m

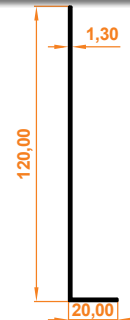

**20x120 Köşebent**  
20x120 Angle Bracket

Paket İçi Adet | 5  
Quantity Per Package

206

0,592 kg/m

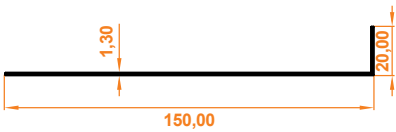

**20x150 Köşebent**  
20x150 Angle Bracket

Paket İçi Adet | 5  
Quantity Per Package

**404**

**0,384 kg/m**

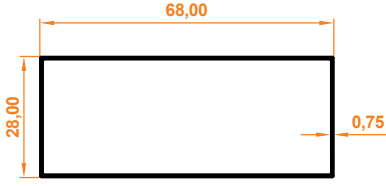

**28x68 Kutu Profil**  
28x68 Box Profile

Paket İçi Adet | 4  
Quantity Per Package

**1044**

**0,960 kg/m**

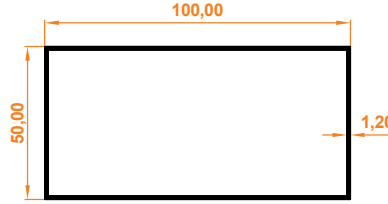

**50x100 Kutu Profil**  
50x100 Box Profile

Paket İçi Adet | 5  
Quantity Per Package

**1102**

**0,531 kg/m**

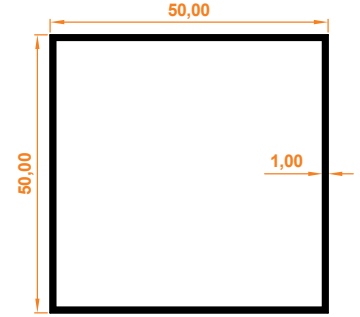

**50x50 Kutu Profil**  
50x50 Box Profile

Paket İçi Adet | 3  
Quantity Per Package

**1400**

**0,426 kg/m**

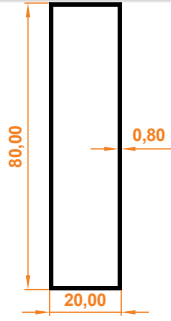

**20x80 Kutu Profil**  
20x80 Box Profile

Paket İçi Adet | 5  
Quantity Per Package

**1402**

**0,917 kg/m**



**95x50 Kutu Profil**  
95x50 Box Profile

Paket İçi Adet | 3  
Quantity Per Package

**1403**

**0,505 kg/m**

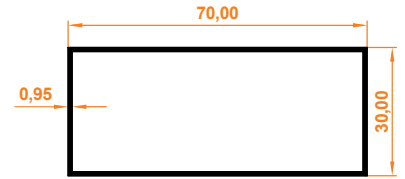

**30x70 Kutu Profil**  
30x70 Box Profile

Paket İçi Adet | 5  
Quantity Per Package

**920**

**0,422 kg/m**

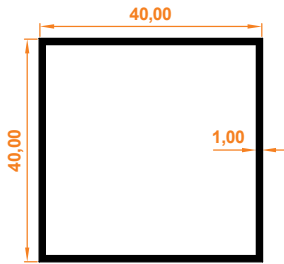

**40x40 Kutu Profil**  
40x40 Box Profile

Paket İçi Adet | 6  
Quantity Per Package

**921**

**0,477 kg/m**

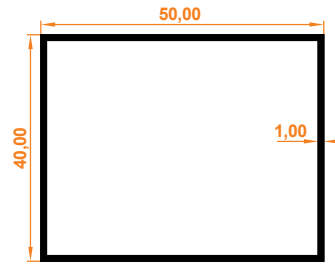

**40x50 Kutu Profil**  
40x50 Box Profile

Paket İçi Adet | 8  
Quantity Per Package

**922**

**0,531 kg/m**

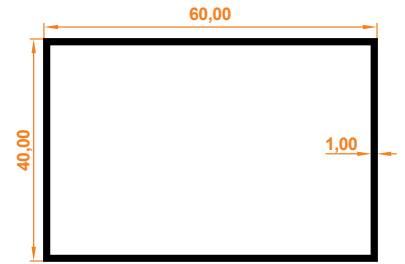

**40x60 Kutu Profil**  
40x60 Box Profile

Paket İçi Adet | 8  
Quantity Per Package

**7180**

**0,576 kg/m**

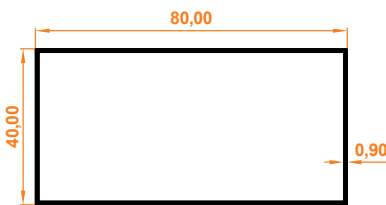

**40x80 Kutu Profil**  
40x80 Box Profile

Paket İçi Adet | 4  
Quantity Per Package

7

0,305 kg/m

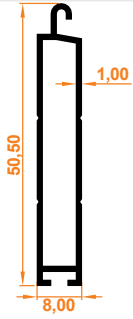

**39x55 Alt Parça**  
39x55 Lower Part

Paket İçi Adet | 6  
Quantity Per Package

8

0,502 kg/m

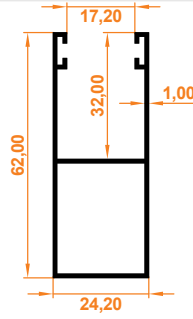

**55'lik Yan Dikme**  
55 Side Column

Paket İçi Adet | 5  
Quantity Per Package

9

0,439 kg/m

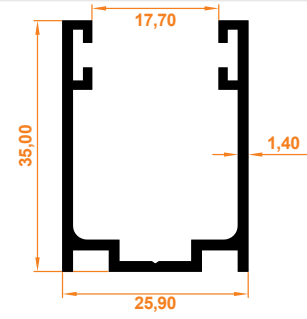

**55'lik Kutusuz Dikme**  
55 Side Column Boxless

Paket İçi Adet | 6  
Quantity Per Package

1130

0,372 kg/m

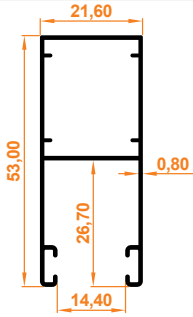

**39'luk Yan Dikme**  
39 Side Column

Paket İçi Adet | 5  
Quantity Per Package

**ÖZEL ÜRETİM PROFİL GRUBU**  
Special Production Profile Group

510

1,174 kg/m

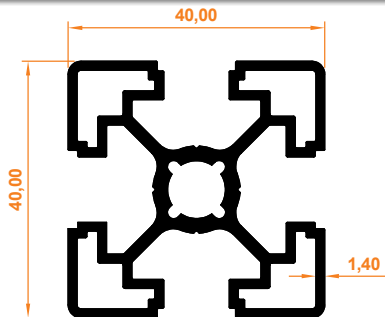

**40x40 Sigma Profil**  
40x40 Sigma Profile

Paket İçi Adet | 3  
Quantity Per Package

1003

0,053 kg/m

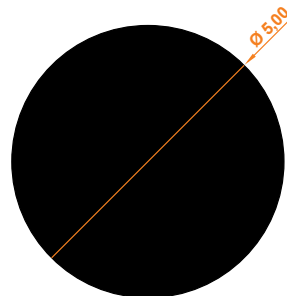

**Q5 Dolu Mil**  
Q5 Solid Bar

Paket İçi Adet | 25  
Quantity Per Package



**GELECEĞİ ŞEKİLLENDİREN: PROCESS**  
İNOVASYONUN VE TASARIMIN BULUŞTUĞU DÜNYA

# TASARIM VE İNOVASYONUN BULUŞMA NOKTASI

TASARIM VE İNOVASYONUN SINIRLARINI AŞAN BİR YOLCULUĞA ÇIKIN. PROCESS ALÜMİNYUM & PVC SİSTEMLERİ, ÇÖZÜMLERİN ÖNCÜSÜDÜR; SINIRLARI YENİDEN TANIMLAR VE İLHAM VEREN ÜRÜNLER SUNAR. BİZİMLE, HAYAL GÜCÜNÜN TITIZLIKLE BİR ARAYA GELDİĞİ BU YOLCULUĞA KATILIN VE BİRLİKTE DAHA PARLAK BİR GELECEK OLUŞTURALIM.

**CRAFTING THE FUTURE: PROCESS'S INNOVATIVE WORLD**

# WHERE DESIGN AND INNOVATION CONVERGE

EMBARK ON A JOURNEY THAT TRANSCENDS THE BOUNDARIES OF DESIGN AND INNOVATION. PROCESS ALUMINIUM & PVC SYSTEMS LEADS THE WAY IN SOLUTIONS, REDEFINING LIMITS, AND OFFERING INSPIRATIONAL PRODUCTS. JOIN US ON THIS JOURNEY WHERE IMAGINATION MEETS PRECISION, AND TOGETHER, LET'S BUILD A BRIGHTER FUTURE.

Process Alüminyum Plastik San. Tic. Ltd. Şti.

**MERKEZ**

Aşağıpınarbaşı OSB Mah. 524 Nolu Sk. No: 3/1 42250,  
Selçuklu-Konya/TÜRKİYE

**T** : +90 332 248 00 92

**F** : +90 332 248 00 93

**M** : info@process.com.tr

**MARMARA BÖLGE MÜDÜRLÜĞÜ**

Cihangir Mh. Talatpaşa Cad. No:67  
Avcılar/İSTANBUL - TÜRKİYE

**T** : +90 212 407 17 42

**F** : +90 212 407 15 42

**M** : marmara@process.com.tr

|| [www.process.com.tr](http://www.process.com.tr)

|| [www.processplise.com.tr](http://www.processplise.com.tr)

|| [www.panjurmen.com.tr](http://www.panjurmen.com.tr)

|| [www.demarco.com.tr](http://www.demarco.com.tr)

|| [www.prosin.com.tr](http://www.prosin.com.tr)

