



Firmamız, **Process Alüminyum ve PVC Sistemleri** ünvanıyla 2002 yılında Konya'da kurulmuştur.

Firmamızın uzmanlaştığı üretim alanları; sineklik sistemleri, cam balkon sistemleri, plise perde sistemleri, zip perde, cam tavan ve tavan kapatma sistemleridir. Tüm bu sistemleri oluşturan plastik aksesuarlar, alüminyum profiller ve polyester tül ile plise perde kumaşları, kendi tesislerimizde üretilmektedir. Tesisimiz 35.000 m² kapalı, 15.000 m² açık alanı olmak üzere toplam 50.000 m²'dir. Plastik enjeksiyon üretim bölümünde 15 adet enjeksiyon makinesi ile 24 saat çalışma esasıyla günlük ortalama 300.000 adet parça üretebilmektedir. Alüminyum ekstrüzyon bölümümüzde aylık ortalama 850 ton alüminyum profil üretilmektedir. Üretilen alüminyum profiller yine kendi tesisimizde yüzey işlemlerinden (eloksal - elektrostatik boya) geçmekte ve son olarak paketlenip sevk edilmektedir. Türkiye içerisinde 900 civarında atölyede ürünlerimiz işlenmekte ve son tüketiciye ulaştırılmaktadır. Türkiye dışında Balkan ülkelerinin tamamı, Avrupa Kıtasında; Almanya, Hollanda, Danimarka, Kuzey Afrikada; Tunus ve Cezayir, Orta Doğuda; Irak ve İsrail'in yanı sıra Ermenistan, Azerbaycan, Arap Emirlikleri, Dubai, Katar, Ürdün gibi ülkelerde bayilikler oluşturulmuştur. Şu anda toplam ürünlerimizin %35'ini ihraç etmekteyiz.

Perde sektöründe son zamanların trend ürünü olan plise perde sistemlerini kendi Ar-Ge merkezimizde geliştirerek sektörün hizmetine sunmuş bulunmaktadır. Mekanik perde atölyeleri tarafından bugüne kadar Türkiye genelinde 150 adet bayilik oluşturulmuş ve bu bayilikler artarak çoğalmaktadır. Plise perdeyi oluşturan tüm parçaları; plastik aksesuarlar, alüminyum çita ve profiller, katlanmış pileli kumaşlar ürünlerimizi kendi tesislerimizde üretilip bayilerimize ulaştırmaktayız. 167 farklı desen ve renkte kumaş çeşidi olan firmamız çok güçlü stok altyapısı ile sektörün ihtiyacı olan hizmeti ve hızı sunmaktadır.

Our company, operating under the name of **Process Aluminum and PVC Systems**, was founded in 2002 in Konya.

Process specializes in the production of the following areas: insect screen systems, glass balcony systems, pleated blind systems, zip blinds, glass roofs, and ceiling closure systems. All the plastic accessories, aluminum profiles, polyester mesh, and pleated blind fabrics that make up these systems are manufactured in our own facilities. Our facility covers a total area of 50,000 m², with 35,000 m² indoors and 15,000 m² outdoors. In the plastic injection production department, we can produce an average of 300,000 pieces per day with 15 injection machines operating 24 hours a day. In our aluminum extrusion department, an average of 850 tons of aluminum profiles are produced monthly. The aluminum profiles produced undergo surface treatments (anodizing - electrostatic paint) in our own facilities before being packaged and shipped. Within Turkey, our products are processed in approximately 900 workshops and delivered to end consumers. Outside of Turkey, we have established dealerships in all Balkan countries, across the European continent including Germany, Netherlands, France, and Denmark, in North Africa including Tunisia and Algeria, in the Middle East including Iraq and Israel, as well as in countries such as Georgia, Armenia, Azerbaijan, the United Arab Emirates, Dubai, Qatar, Jordan, and more. Currently, we export 35% of our total products.

In the curtain sector, our company has developed and introduced pleated blind systems, the trend product of recent years, to the market through our own R&D center. Nowadays, we have established 150 dealerships across Turkey in the mechanical curtain workshops, and the number of dealers is increasing. We manufacture all the components that make up pleated blinds, including plastic accessories, aluminum bars, profiles, and folded pleated fabrics, in our own facilities and deliver them to our dealers. With 167 different patterns and colors of fabric, our company provides the service and speed that the market needs with its strong stock level.





GELECEK YAPI MİMARİ
Tüm Yaşam Alanlarında

In all living areas

Future Structure Architecture



KALİTE
QUALITY

EKONOMİK
ECONOMIC

GARANTİ
WARRANTY



ÜRÜN KODU Product Code	ÖZELLİKLERİ Properties	ÖLÇÜLERİ Dimensions	RENKLER Colors	KOLI İÇİ ADET Quantity Per Box
PJM - 01	Panjurmen Menfez / Vent	27 x 32	□ ■ ■	20
PJM - 02	Panjurmen Menfez / Vent	25 x 45	□ ■ ■	20
PJM - 19	Panjurmen Menfez / Vent	30 x 30	□ ■ ■	20
PJM - 16	Panjurmen Menfez / Vent	30 x 40	□	20
PJM - 03	Panjurmen Menfez / Vent	35 x 35	□ ■ ■	20
PJM - 04	Panjurmen Menfez / Vent	35 x 45	□ ■ ■	20
PJM - 05	Panjurmen Menfez / Vent	35 x 55	□ ■ ■	20
PJM - 06	Panjurmen Menfez / Vent	40 x 40	□ ■ ■	20
PJM - 15	Panjurmen Menfez / Vent	40 x 50	□	20
PJM - 07	Panjurmen Menfez / Vent	45 x 45	□ ■ ■	20
PJM - 08	Panjurmen Menfez / Vent	45 x 55	□ ■ ■	20
PJM - 09	Panjurmen Menfez / Vent	45 x 65	□ ■ ■	20
PJM - 10	Panjurmen Menfez / Vent	65 x 45	□	20
PJM - 11	Panjurmen Menfez / Vent	50 x 50	□ ■ ■	20
PJM - 17	Panjurmen Menfez / Vent	50 x 60	□	20
PJM - 12	Panjurmen Menfez / Vent	55 x 55	□ ■ ■	20
PJM - 13	Panjurmen Menfez / Vent	55 x 65	□	20
PJM - 18	Panjurmen Menfez / Vent	60 x 60	□ ■ ■	20
PJM - 14	Panjurmen Menfez / Vent	65 x 65	□ ■ ■	15

CMS 01

Parlak Eloksal
Gloss Anodized



Boru Tipi Çamaşır Askısı
Pipe Type Clotheshorse

Koli İçi Adet
Quantity Per Box

20

CMS 02

Parlak Eloksal
Gloss Anodized



Duvar Tipi Çamaşır Askısı
Wall Type Clotheshorse

Koli İçi Adet
Quantity Per Box

15

CMS 03

Parlak Eloksal
Gloss Anodized



Ayarlı Kare Çamaşır Askısı (25x60cm ve 30x80 cm)
Adjustable Square Clotheshorse (25x60cm and 30x80cm)

Koli İçi Adet
Quantity Per Box

20

CMS 04

Parlak Eloksal
Gloss Anodized



25x60cm Çamaşır Askısı
25x60cm Clotheshorse

Koli İçi Adet
Quantity Per Box

20

CMS 05

Parlak Eloksal
Gloss Anodized



30x80cm Çamaşır Askısı
30x80cm Clotheshorse

Koli İçi Adet
Quantity Per Box

20

CMS 06

Parlak Eloksal
Gloss Anodized



Lüks Çamaşır Askısı
Luxurious Clotheshorse

Koli İçi Adet
Quantity Per Box

20

CMS 07

Parlak Eloksal
Gloss Anodized



40x40 Kare Çamaşır Askısı
40x40 Square Clotheshorse

Koli İçi Adet
Quantity Per Box

20

Alüminyum Renk Seçeneği

Aluminum Color Options

PB

Parlak Eloksal
Gloss Anodized

P0

Parlak Bronz
Gloss Bronze

7016

Antrasit Gri
Anthracite Gray



ÜRÜN ADI Product Name	AÇIKLAMA Explanation
Doğalgaz Takım (Isıcam) Natural Gas Set (Double-Glass)	3 m
Doğalgaz Sağ-Sol Başlık Natural Gas Right-Left Header (CAP)	Adet Pcs
Doğalgaz Takım (Tekcam 8mm) Natural Gas Set (Single-Glass 8mm)	3 m
Doğalgaz Takım (Tekcam 10mm) Natural Gas Set (Single-Glass 10mm)	Adet Pcs
Doğalgaz Sağ-Sol Başlık Natural Gas Right-Left Header (CAP)	3 m
Oda Havalandırma Room Ventilation	3 m
Sağ-Sol Başlık Right Left Header (CAP)	Adet Pcs

ONAYLI ÜRÜN
APPROVED PRODUCT



Ürünlerimiz Patentli Olup;
İGDAŞ Onaylıdır.

Our products have patent
and approved by İGDAŞ.

AYARLI CAM TAKOZU

Adjustable Glass Wedges

ÜRÜN ADI Product Name	ÜRÜN KODU Product Code	KOLİ İÇİ ADET (m ²) Quantity Per Box (m ²)
18 mm Ayarlı Cam Takozu / 18 mm Adjustable Glass Wedge	ACT 1	500
24 mm Ayarlı Cam Takozu / 24 mm Adjustable Glass Wedge	ACT 2	400
28 mm Ayarlı Cam Takozu / 28 mm Adjustable Glass Wedge	ACT 3	400
32 mm Ayarlı Cam Takozu / 32 mm Adjustable Glass Wedge	ACT 4	400
Ayarlı Cam Takozu Pensesi / Adjustable Glass Wedge Holder	ACT 5	1



ÖZELLİKLER

PROPERTIES

Kanat sarkmalarını ortadan kaldırır.

It eliminates wing sagging.

PVC, ahşap ve alüminyum doğramalarda kullanılabilir.

It can be used in PVC, wood and aluminum joinery.

Ayar pensesi sayesinde kanadınızın kolaylıkla teraziye alınmasını sağlar.

With the adjustment pliers, your wing can be easily leveled.

Ekstra takoz seçeneğiyle standartların üzerinde kaldırma kapasitesine sahiptir.

It has a lifting capacity above standards with extra chock option.





⊕ İşaretili ürünler özel üretimdir.
⊕ Marked products are special production.

ÜRÜN KODU Product Code	ÖLÇÜLERİ Dimensions	KOLİ İÇİ RULO Quantity Per Box (roll)	RULO/METRE Roll/Meter	KOLİ İÇİ ADET (m) Quantity Per Box (m)
FİTİL 72 ⊕	45-800	4	275	1.100
FİTİL 01 ⊕	48-300	4	800	3.200
FİTİL 02	48-450	4	550	2.200
FİTİL 03	48-500	4	550	2.200
FİTİL 04	48-550	4	500	2.000
FİTİL 05	48-600	4	450	1.800
FİTİL 06	48-650	4	450	1.800
FİTİL 07 ⊕	48-700	4	400	1.600
FİTİL 08	48-800	4	275	1.100
FİTİL 66 ⊕	48-900	4	250	1.000
FİTİL 09	48-1000	4	250	1.000
FİTİL 10	48-1200	4	200	800
FİTİL 60 ⊕	48-1500	4	150	600
FİTİL 11	51-500	4	375	1.500
FİTİL 54	51-550	4	375	1.500
FİTİL 12	51-650	4	350	1.400
FİTİL 13	51-800	4	325	1.300
FİTİL 14	51-1000	4	250	1.000
FİTİL 15 ⊕	51-1200	4	200	800
FİTİL 16	55-550	4	375	1.500
FİTİL 68 ⊕	55-600	4	350	1.400
FİTİL 67 ⊕	55-650	4	350	1.400
FİTİL 17	55-700	4	350	1.400
FİTİL 18	55-800	4	325	1.300
FİTİL 65 ⊕	55-1000	4	250	1.000
FİTİL 19	60-575	4	350	1.400
FİTİL 20	67-450	4	375	1.500
FİTİL 21	67-500	4	375	1.500
FİTİL 22	67-550	4	375	1.500
FİTİL 23	67-600	4	350	1.400
FİTİL 24	67-650	4	350	1.400
FİTİL 46	67-700	4	300	1.200
FİTİL 26	67-800	4	250	1.000
FİTİL 61	67-900	4	225	900
FİTİL 28	67-1000	4	200	800
FİTİL 29 ⊕	67-1100	4	175	700
FİTİL 30	67-1200	4	175	700
FİTİL 31	67-1500	4	125	500
FİTİL 32 ⊕	67-1800	4	125	500
FİTİL 33 ⊕	67-2000	4	100	400
FİTİL 74 ⊕	67-2500	4	75	300
FİTİL 34 ⊕	69-550	4	375	1.500
FİTİL 35	69-700	4	250	1.000
FİTİL 36 ⊕	69-1000	4	200	800
FİTİL 37 ⊕	69-1200	4	175	700
FİTİL 38	72-800	4	200	800
FİTİL 39	127-700	4	150	600
FİTİL 73 ⊕	51-550 Finli (Finned)	4	350	1.400
FİTİL 40	51-650 Finli (Finned)	4	325	1.300
FİTİL 41	51-800 Finli (Finned)	4	300	1.200
FİTİL 42 ⊕	51-1000 Finli (Finned)	4	225	900
FİTİL 77 ⊕	55-650 Finli (Finned)	4	325	1.300
FİTİL 43	55-700 Finli (Finned)	4	325	1.300
FİTİL 44	55-800 Finli (Finned)	4	300	1.200
FİTİL 45	60-575 Finli (Finned)	4	325	1.300
FİTİL 76 ⊕	67-600 Finli (Finned)	4	325	1.300
FİTİL 55 ⊕	67-650 Finli (Finned)	4	325	1.300
FİTİL 58	67-700 Finli (Finned)	4	275	1.100
FİTİL 47	67-1000 Finli (Finned)	4	175	700
FİTİL 48	67-1200 Finli (Finned)	4	150	600
FİTİL 49	69-700 Finli (Finned)	4	225	900
FİTİL 50	69-800 Finli (Finned)	4	225	900
FİTİL 51	69-1000 Finli (Finned)	4	175	700
FİTİL 52	72-800 Finli (Finned)	4	175	700
FİTİL 53	127-700 Finli (Finned)	4	125	500
FİTİL 105	67-800 Finli Tela (Finned)	4	175	700

ÜRÜN ADI Product Name	ÜRÜN KODU Product Code	RULO m ² Roll m ²	KOLI İÇİ ADET (m ²) Amount within Parcel (m ²)
60cmx30m Sineklik Tülü / 60cmx30m Flynet Tulle	60 S	18 m ²	6
80cmx30m Sineklik Tülü / 80cmx30m Flynet Tulle	80 S	24 m ²	6
100cmx30m Sineklik Tülü / 100cmx30m Flynet Tulle	100 S	30 m ²	6
120cmx30m Sineklik Tülü / 120cmx30m Flynet Tulle	120 S	36 m ²	6
140cmx30m Sineklik Tülü / 140cmx30m Flynet Tulle	140 S	42 m ²	6
160cmx30m Sineklik Tülü / 160cmx30m Flynet Tulle	160 S	48 m ²	6
180cmx30m Sineklik Tülü / 180cmx30m Flynet Tulle	180 S	54 m ²	6
200cmx30m Sineklik Tülü / 200cmx30m Flynet Tulle	200 S	60 m ²	6
220cmx30m Sineklik Tülü / 220cmx30m Flynet Tulle	220 S	66 m ²	6
240cmx30m Sineklik Tülü / 240cmx30m Flynet Tulle	240 S	72 m ²	6
Pet Tül 100 / Pet Tulle 100	100 PET	10 m ²	6
Pet Tül 120 / Pet Tulle 120	120 PET	12 m ²	6
Pet Tül 140 / Pet Tulle 140	140 PET	14 m ²	6
Pet Tül 160 / Pet Tulle 160	160 PET	16 m ²	6
Pet Tül 220 / Pet Tulle 220	220 PET	22 m ²	6

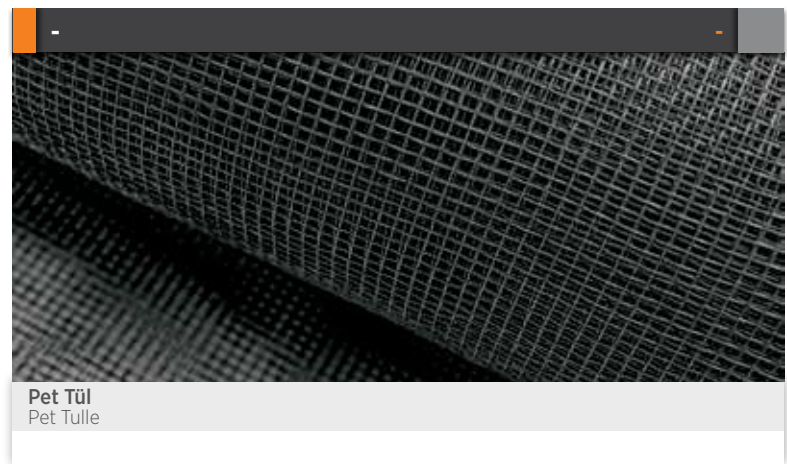

GOLD SERİ PLİSE SİNEKLİK / GOLD SERIES PLEATED FLY SCREEN

İçten Gergi

Internal Tensioner

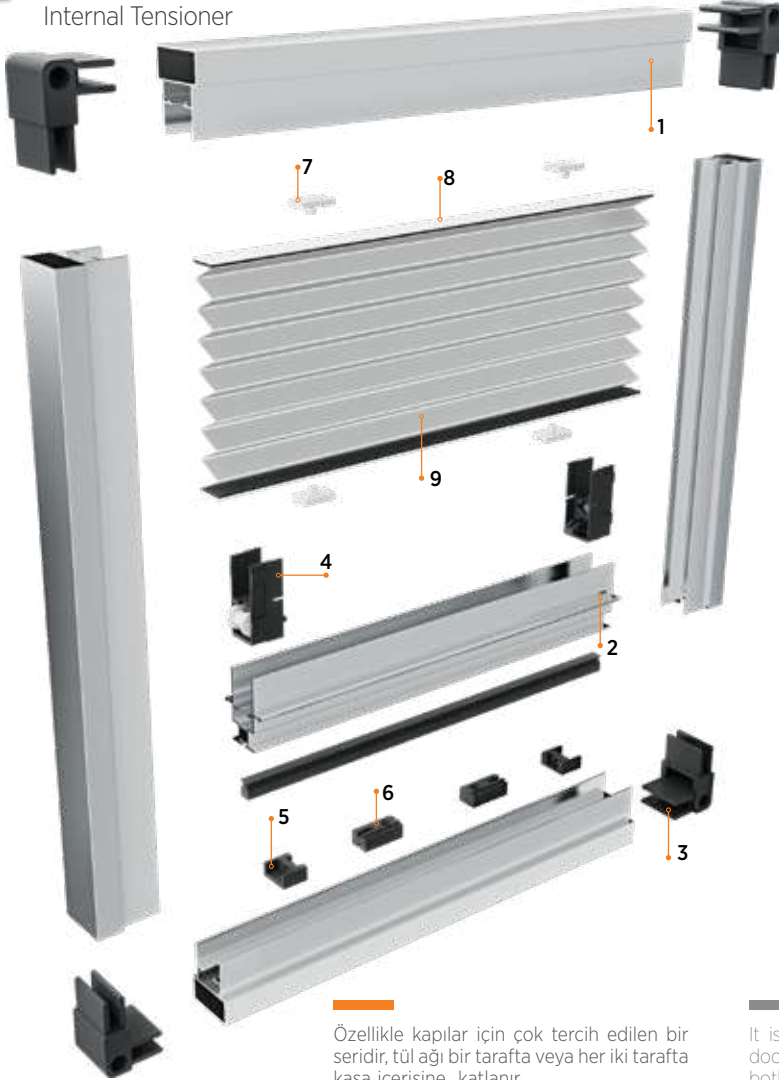

Özellikle kapılar için çok tercih edilen bir seridir, tül ağı bir tarafta veya her iki tarafta kasa içerisine katlanır.

Pileli kaset, alüminyum kasa profili ile kapı veya pencere pervazına, köşe takozlarında yer alan montaj deliklerinden vida yardımıyla doğrudan ve kolayca sabitlenir. 19 mm tül ve banta uygundur.

It is a very preferred series especially for doors, tulle net folds on one side or folds on both sides into the case.

The Gold series fly screen system is directly and easily fixed to the door or window sill with the help of screws through the mounting holes in the corner wedges. Suitable for 19 mm tulle and tape.



İçten Gergi Set İçeriği / Internal Tensioner Set Contents

No	ÜRÜN KODU Product Code	ÜRÜN ADI Product Name
1	304	Gold Kasa Gold Case
2	305	Gold Kanat Gold Wing
3	PLS 70	Köşe Takozu Corner Wedge
4	PLS 72	Rulman Takımı Bearing Set
5	PLS 73	İp Kontrol Plastiği Rope Control Plastic
6	PLS 74	İp Gergi Takozu Rope Tensioner Chock
7	PLS 150	Delikli Klips Hole Clip
8	PLS 51	PVC Bantlı Şerit PVC Taped Stripe
9	-	Plise Tül Pleated Tulle



304
Gold Kasa Profil
Gold Case Profile
Paket İçi Adet
Quantity Per Package 10 Gramajı
Weight 0,318 kg/m



305
Gold Kanat Profil
Gold Wing profile
Paket İçi Adet
Quantity Per Package 10 Gramajı
Weight 0,330 kg/m



AKS 09
AKS 10 Beyaz / White
Siyah / Black
Gold Seri İçten Gergi Aksesuar Seti
Gold Serie Internal Tensioner Accessory Set
Koli İçi Adet
Quantity Per Box 100 Set Renk
Color

Alüminyum Renk Seçeneği

Aluminum Color Options

9016

Beyaz
White

Eloksal Boyalı
Anodized Painted

Bronz Boyalı
Bronze Painted

8003

Altın Meşe
Golden Oak

8016

Maun
Mahogany

7016

Antrasit Gri
Anthracite Gray

STAR SERİ PLİSE SİNEKLİK / STAR SERIES PLEATED FLY SCREEN

Köşeden Gergi

Corner Tensioner

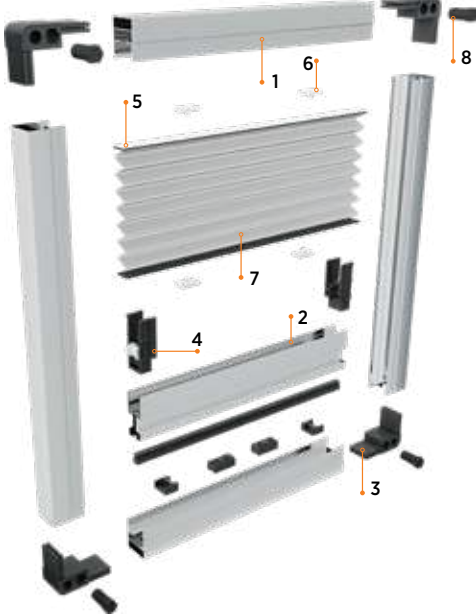

Köşeden Gergi Set İçeriği / Corner Tensioner Set Contents

No	ÜRÜN KODU Product Code	ÜRÜN ADI Product Name
1	356	Star Kasa Star Case
2	307	Star Kanat Star Wing
3	PLS 100	Köşe Takoğu Corner Wedge
4	PLS 102	Rulman Takımı Bearing Set
5	PLS 51	PVC Bantlı Şerit PVC Taped Stripe
6	PLS 450	Delikli Klips Hole Clip
7	-	Plise Tül Pleated Tulle
8	PLS 104	Köşe Takoğu Pimi Corner Wedge Pin

AKS 05
AKS 06

Beyaz / White
Siyah / Black



Star Seri Köşeden Gergi Aksesuar Seti
Star Series Corner Tensioner Accessory Set

Koli İçi Adet Quantity Per Box	100 Set	Renk Color	<input type="checkbox"/>	<input type="checkbox"/>
-----------------------------------	---------	---------------	--------------------------	--------------------------

307



Star Kanat Profil
Star Wing Profile

Paket İçi Adet Quantity Per Package	10	Gramajı Weight	0,304 kg/m
--	----	-------------------	------------

356



Star Kasa Profil
Star Case Profile

Paket İçi Adet Quantity Per Package	10	Gramajı Weight	0,271 kg/m
--	----	-------------------	------------

İçten Gergi

Internal Tensioner

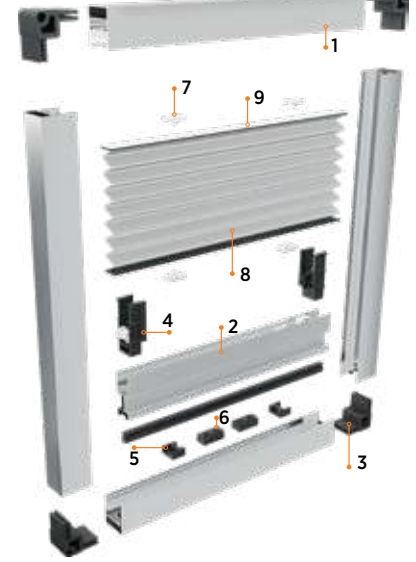

İçten Gergi Set İçeriği / Internal Tensioner Set Contents

No	ÜRÜN KODU Product Code	ÜRÜN ADI Product Name
1	356	Star Kasa Star Case
2	307	Star Kanat Star Wing
3	PLS 402	Köşe Takoğu Corner Wedge
4	PLS 102	Rulman Takımı Bearing Set
5	PLS 430	İp Kontrol Rope Control
6	PLS 431	İp Gergi Takoğu Rope Tensioner Chock
7	PLS 450	Delikli Klips Hole Clip
8	-	Plise Tül Pleated Tulle
9	PLS 51	PVC Bantlı Şerit PVC Taped Stripe

AKS 07
AKS 08

Beyaz / White
Siyah / Black



Star Serie İçten Gergi Aksesuar Seti
Star Serie Internal Tensioner Accessory Set

Koli İçi Adet Quantity Per Box	100 Set	Renk Color	<input type="checkbox"/>	<input type="checkbox"/>
-----------------------------------	---------	---------------	--------------------------	--------------------------

Alüminyum Renk Seçeneği

Aluminum Color Options

9016

Beyaz
White

Eloksal Boyalı
Anodized Painted

Bronz Boyalı
Bronze Painted

8003

Altın Meşe
Golden Oak

8016

Maun
Mahogany

7016

Antrasit Gri
Anthracite Gray

İki model vardır: Köşeden Gergi ve İçten Gergi. Her model için farklı aksesuarlar mevcuttur.

Kasa genişliğinin Gold serisinden daha dar olması nedeniyle bazı alanlarda montaj kolaylığı sağlar. 19 mm tül ve banta uygundur.

There are two models: Corner Tensioner and Internal Tensioner. Different accessories are available for each model.

Due to the narrower width of the case than the Gold series, in some areas provides ease of assembly. Suitable for 19 mm tulle and tape.

SLİM SERİ PLİSE SİNEKLİK / SLIM SERIES PLEATED FLY SCREEN

Köşeden Gergi

Corner Tensioner

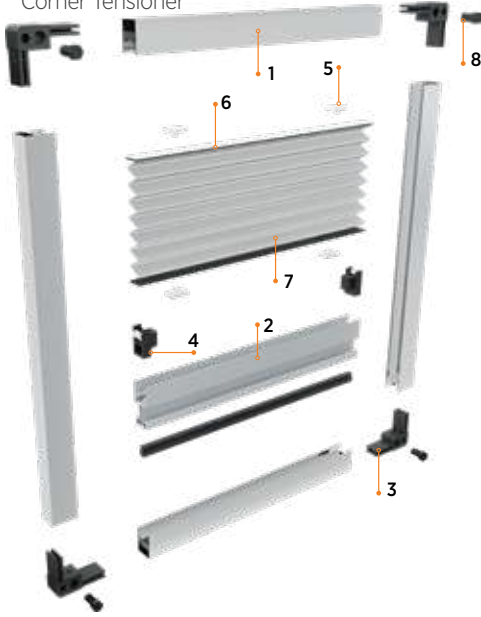

Köşeden Gergi Set İçeriği / Corner Tensioner Set Contents

No	ÜRÜN KODU Product Code	ÜRÜN ADI Product Name
1	300	Slim Kasa Slim Case
2	358	Slim Kanat Slim Wing
3	PLS 110	Köşe Takozu Corner Wedge
4	PLS 112	Rulman Takımı Bearing Set
5	PLS 550	Delikli Klips Hole Clip
6	PLS 50	PVC Bantlı Şerit PVC Taped Stripe
7	-	Plise Tül Pleated Tulle
8	PLS 115	Köşe Takozu Pimi Corner Wedge Pin

İçten Gergi

Internal Tensioner

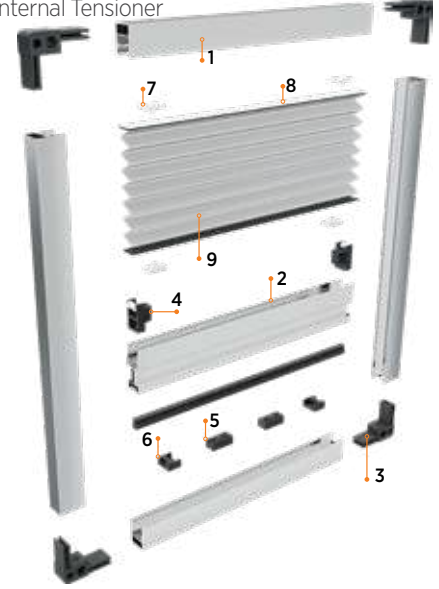

İçten Gergi Set İçeriği / Internal Tensioner Set Contents

No	ÜRÜN KODU Product Code	ÜRÜN ADI Product Name
1	300	Slim Kasa Slim Case
2	358	Slim Kanat Slim Wing
3	PLS 502	Köşe Takozu Corner Wedge
4	PLS 112	Rulman Takımı Bearing Set
5	PLS 114	İp Gergi Takozu Rope Tensioner Chock
6	PLS 113	İp Kontrol Plastiği Rope Control Plastic
7	PLS 550	Delikli Klips Hole Clip
8	PLS 50	PVC Bantlı Şerit PVC Taped Stripe
9	-	Plise Tül Pleated Tulle

Alüminyum Renk Seçeneği

Aluminum Color Options

9016 Beyaz White	Eloksal Boyalı Anodized Painted	Bronz Boyalı Bronze Painted
8003 Altın Meşe Golden Oak	8016 Maun Mahogany	7016 Antrasit Gri Anthracite Gray

AKS 01 Beyaz / White AKS 02 Siyah / Black



Slim Seri Köşeden Gergi Aksesuar Seti
Slim Series Corner Tensioner Accessory Set

Koli İçi Adet Quantity Per Box	100 Set	Renk Color	<input type="checkbox"/>	<input type="checkbox"/>
-----------------------------------	---------	---------------	--------------------------	--------------------------

AKS 01 E Beyaz / White AKS 02 E Siyah / Black



Slim Köşeden Gergi Eşiksiz Aksesuar Seti
Slim Corner Tensioner Accessory Set without Threshold

Koli İçi Adet Quantity Per Box	100 Set	Renk Color	<input type="checkbox"/>	<input type="checkbox"/>
-----------------------------------	---------	---------------	--------------------------	--------------------------

AKS 03 Beyaz / White AKS 04 Siyah / Black



Slim Seri İçten Gergi Aksesuar Seti
Slim Serie Internal Tensioner Accessory Set

Koli İçi Adet Quantity Per Box	100 Set	Renk Color	<input type="checkbox"/>	<input type="checkbox"/>
-----------------------------------	---------	---------------	--------------------------	--------------------------

300



Slim Kasa Profil
Slim Case Profile

Paket İçi Adet Quantity Per Package	10	Gramajı Weight	0,218 kg/m
--	----	-------------------	------------

358



Slim Eşiksiz Profil
Slim Profile without Threshold

Paket İçi Adet Quantity Per Package	12	Gramajı Weight	0,111 kg/m
--	----	-------------------	------------

359



Slim Kanat Profil
Slim Wing Profile

Paket İçi Adet Quantity Per Package	10	Gramajı Weight	0,321 kg/m
--	----	-------------------	------------

JUNIOR SERİ PLİSE SİNEKLİK / JUNIOR SERIES PLEATED FLY SCREEN

Köşeden Gergi

Corner Tensioner

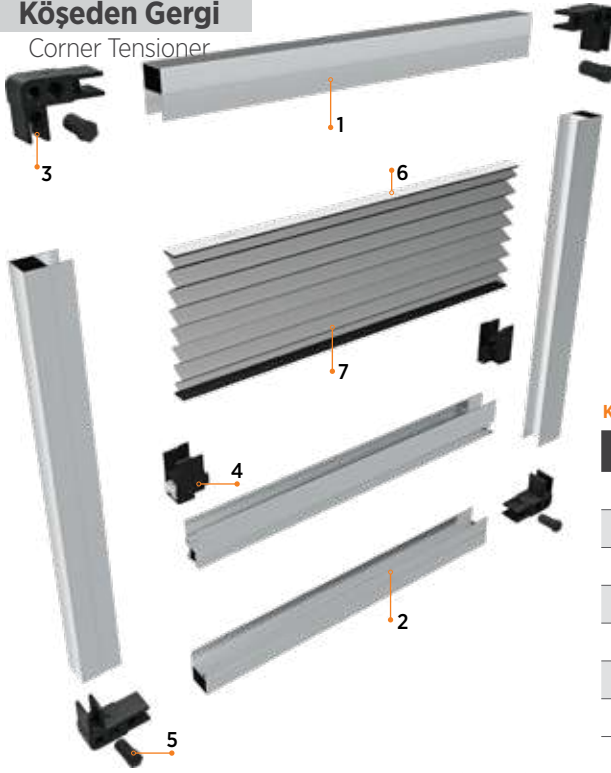

Köşeden Gergi Set İçeriği / Corner Tensioner Set Contents

No	ÜRÜN KODU Product Code	ÜRÜN ADI Product Name
1	306	Junior Kasa Profili Junior Case Profile
2	307	Junior Kanat Profili Junior Wing Profile
3	PLS 80	Köşe Takozu Corner Wedge
4	PLS 82	Rulman Takımı Bearing Set
5	PLS 83	Köşe Takozu Pimi Corner Wedge Pin
6	PLS 50-51	PVC Bantlı Şerit PVC Taped Stripe
7	-	Plise Tülü Pleated Tulle

Junior Seri, pratik ve estetik bir sineklik çözümü sunar. Köşeden gergi sistemiyle tasarlanan bu model, kullanımı kolay ve dayanıklıdır. Evinize zarif bir görünüm katan Junior Seri, sineklik ihtiyaçlarınızı en iyi şekilde karşılar. 16 ve 19 mm tül ve banta uygundur.

Junior Series offers a practical and aesthetic solution for insect screens. Designed with a corner tensioning system, this model is easy to use and durable. Adding an elegant look to your home, Junior Series meets your insect screen needs perfectly. Suitable for 16 and 19 mm tulle and tape.

AKS 15
AKS 16

Beyaz / White
Siyah / Black



Junior Seri Köşeden Gergi Aksesuar Seti
Junior Seri Corner Tensioner Accessory Set

Koli İçi Adet Quantity Per Box	100 Set	Renk Color	<input type="checkbox"/>	<input type="checkbox"/>
-----------------------------------	---------	---------------	--------------------------	--------------------------

347



Junior Büyük Kasa Profil
Junior Big Case Profile

Paket İçi Adet Quantity Per Package	10	Gramajı Weight	0,445 kg/m
--	----	-------------------	------------

AKS 28
AKS 29

Beyaz / White
Siyah / Black



Junior Seri Büyük Köşeden Gergi Aksesuar Seti
Junior Seri Big Corner Tensioner Accessory Set

Koli İçi Adet Quantity Per Box	100 Set	Renk Color	<input type="checkbox"/>	<input type="checkbox"/>
-----------------------------------	---------	---------------	--------------------------	--------------------------

AKS 15 E
AKS 16 E

Beyaz / White
Siyah / Black



Junior Seri Köşeden Gergi Eşiksiz Aksesuar Seti
Junior Seri Corner Tensioner without Threshold Accessory Set

Koli İçi Adet Quantity Per Box	100 Set	Renk Color	<input type="checkbox"/>	<input type="checkbox"/>
-----------------------------------	---------	---------------	--------------------------	--------------------------

306

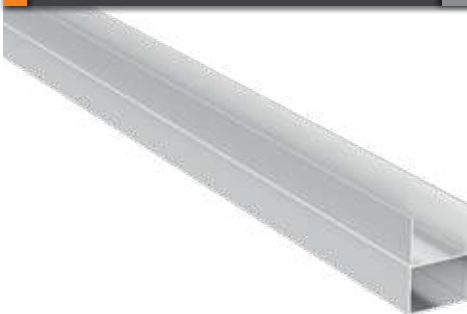

Junior Kasa Profil
Junior Case Profile

Paket İçi Adet Quantity Per Package	10	Gramajı Weight	0,243 kg/m
--	----	-------------------	------------

307



Junior Kanat Profil
Nobel Wing Profile

Paket İçi Adet Quantity Per Package	10	Gramajı Weight	0,304 kg/m
--	----	-------------------	------------

345



Junior Eşiksiz Kasa Profil
Junior Case Profile without Threshold

Paket İçi Adet Quantity Per Package	12	Gramajı Weight	0,162 kg/m
--	----	-------------------	------------

Alüminyum Renk Seçeneği

Aluminum Color Options

9016

Beyaz
White



Eloksoal Boyalı
Anodized Painted



Bronz Boyalı
Bronze Painted

8003

Altın Meşe
Golden Oak

8016

Maun
Mahogany

7016

Antrasit Gri
Anthracite Gray

SÜPER SERİ PLİSE SİNEKLİK / SUPER SERIES PLEATED FLY SCREEN

Köşeden Gergi

Corner Tensioner

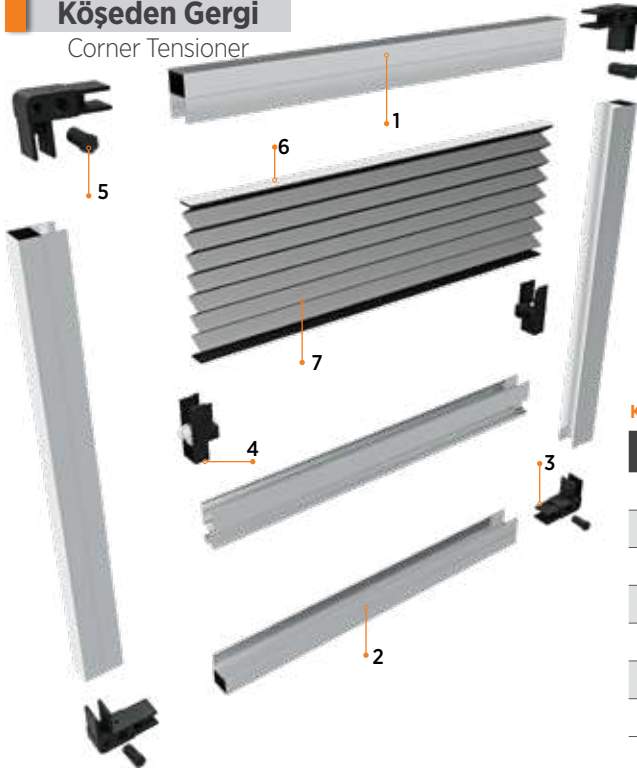

Köşeden Gergi Set İçeriği / Corner Tensioner Set Contents

No	ÜRÜN KODU Product Code	ÜRÜN ADI Product Name
1	316	Süper Kasa Profili Super Case Profile
2	320	Süper Kanat Profili Super Wing Profile
3	PLS 90	Köşe Takoğu Corner Wedge
4	PLS 92	Rulman Takımı Bearing Set
5	PLS 94	Köşe Takoğu Pimi Corner Wedge Pin
6	PLS 50	PVC Bantlı Şerit PVC Taped Stripe
7	-	Plise Tül Pleated Tulle

Kapı ve pencereler için tasarlanmış özel bir modeldir. Montajı, panjur ile kapı-pencere pervazı arasındaki boşluğa kolayca yapılabilir. Bu ürün, panjurlu kapı ve pencerelerde de sineklik kullanımını mümkün kılar. 16 mm tül ve banta uygundur.

It is a specially designed model for doors and windows with shutters. It can be easily installed in the space between the shutter and the door-window frame. This product allows the use of insect screens on doors and windows with shutters. Suitable for 16 mm tulle and tape.

AKS 26
AKS 27

Beyaz / White
Siyah / Black



Süper Seri Orta Köşeden Gergi Aksesuar Seti Super Serie Middle Corner Tensioner Accessory Set

Koli İçi Adet Quantity Per Box	100 Set	Renk Color	<input type="checkbox"/>	<input type="checkbox"/>
-----------------------------------	---------	---------------	--------------------------	--------------------------

320



Süper Kanat Profil Super Wing profile

Paket İçi Adet Quantity Per Package	10	Gramajı Weight	0,303 kg/m
--	----	-------------------	------------

AKS 11
AKS 12

Beyaz / White
Siyah / Black



Süper Seri Köşeden Gergi Aksesuar Seti Super Serie Corner Tensioner Accessory Set

Koli İçi Adet Quantity Per Box	100 Set	Renk Color	<input type="checkbox"/>	<input type="checkbox"/>
-----------------------------------	---------	---------------	--------------------------	--------------------------

AKS 24
AKS 25

Beyaz / White
Siyah / Black



Süper Seri Büyük Köşeden Gergi Aksesuar Seti Super Serie Big Corner Tensioner Accessory Set

Koli İçi Adet Quantity Per Box	100 Set	Renk Color	<input type="checkbox"/>	<input type="checkbox"/>
-----------------------------------	---------	---------------	--------------------------	--------------------------

316



Süper Kasa Profil Super Case Profile

Paket İçi Adet Quantity Per Package	10	Gramajı Weight	0,248 kg/m
--	----	-------------------	------------

354



Süper Orta Kasa Profil Super Middle Case Profile

Paket İçi Adet Quantity Per Package	6	Gramajı Weight	0,363 kg/m
--	---	-------------------	------------

325



Süper Büyük Kasa Profil Super Big Case Profile

Paket İçi Adet Quantity Per Package	4	Gramajı Weight	0,469 kg/m
--	---	-------------------	------------

Alüminyum Renk Seçeneği

Aluminum Color Options

9016

Beyaz
White



Eloksoal Boyalı
Anodized Painted



Bronz Boyalı
Bronze Painted

8003

Altın Meşe
Golden Oak

8016

Maun
Mahogany

7016

Antrasit Gri
Anthracite Gray

NOBEL SERİ PLİSE SİNEKLİK / NOBEL SERIES PLEATED FLY SCREEN

Köşeden Gergi

Corner Tensioner

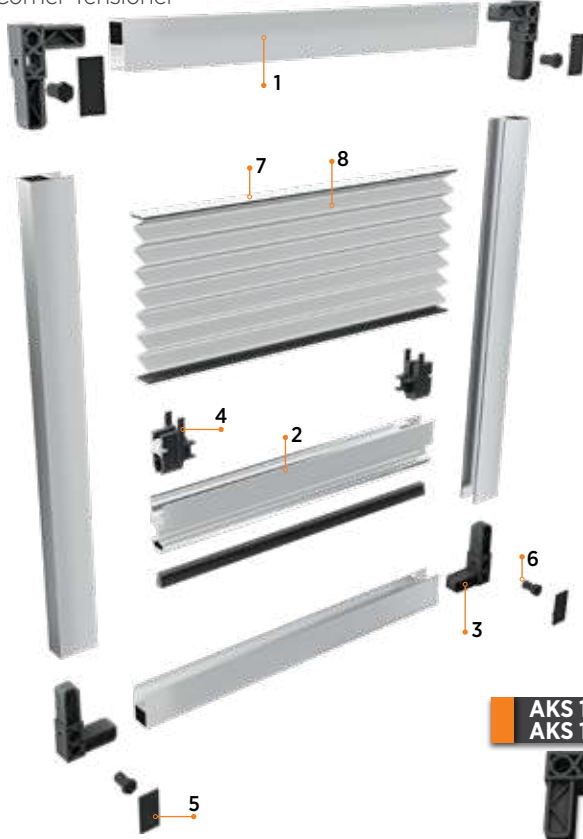

Yeni Ürün New Product

Köşeden Gergi Set İçeriği / Corner Tensioner Set Contents

No	ÜRÜN KODU Product Code	ÜRÜN ADI Product Name
1	338	Nobel Kasa Profili Nobel Case Profile
2	335	Nobel Kanat Profili Nobel Wing Profile
3	PLS 120	Nobel Köşe Takoğu Nobel Corner Wedge
4	PLS 122	Nobel Rulman Takımı Nobel Bearing Set
5	PLS 610	Nobel Köşe Takoğu Kapağı Nobel Corner Wedge Cover
6	PLS 125	Nobel Köşe Takoğu Pimi Nobel Corner Wedge Pin
7	PLS 52	PVC Bantlı Şerit PVC Taped Stripe
8	-	Plise Tül Pleated Tulle

Özellikle panjur ve karavan gibi dar alanlarda tercih edilen bir sistemdir. Kasa genişliği diğer serilere göre daha küçüktür. Bu ürünle birlikte panjur sistemlerinde kullanım imkânı sağlayan slim seriyeye alternatif olarak değerlendirilmektedir. 14 mm tül ve banta uygundur.

It is a preferred system, especially in narrow areas such as shutters and caravans. The case width is smaller than that of other series. With this product, it is considered an alternative to the slim series, which provides the opportunity to be used in shutter systems. Suitable for 14 mm tulle and tape.

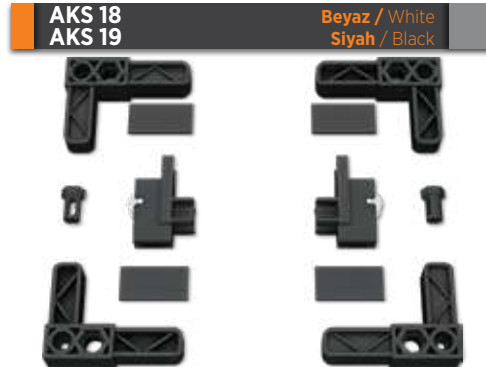

Nobel Köşeden Gergi Aksesuar Seti
Nobel Corner Tensioner Accessory Set

Koli İçi Adet Quantity Per Box	100 Set	Renk Color	<input type="checkbox"/>	<input type="checkbox"/>
-----------------------------------	---------	---------------	--------------------------	--------------------------

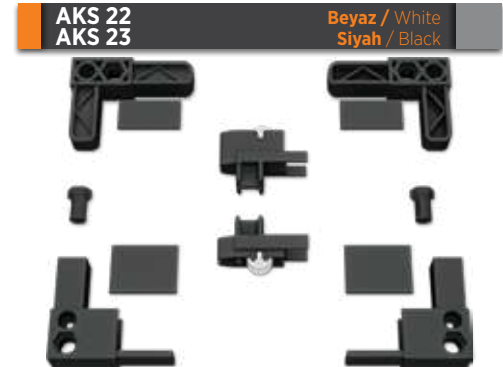

Nobel Köşeden Gergi Eşiksiz Aksesuar Seti

Nobel Corner Tensioner Accessory Set without Threshold

Koli İçi Adet Quantity Per Box	100 Set	Renk Color	<input type="checkbox"/>	<input type="checkbox"/>
-----------------------------------	---------	---------------	--------------------------	--------------------------



Nobel Kanat Profil
Nobel Wing Profile

Paket İçi Adet Quantity Per Package	10	Gramajı Weight	0,345 kg/m
--	----	-------------------	------------



Nobel Eşiksiz Kasa Profil
Nobel Case Profile without Threshold

Paket İçi Adet Quantity Per Package	10	Gramajı Weight	0,098 kg/m
--	----	-------------------	------------



Nobel Kasa Profil
Nobel Case Profile

Paket İçi Adet Quantity Per Package	10	Gramajı Weight	0,250 kg/m
--	----	-------------------	------------

Alüminyum Renk Seçeneği

Aluminum Color Options

9016

Beyaz
White



Eloksal Boyalı
Anodized Painted



Bronz Boyalı
Bronze Painted

8003

Altın Meşe
Golden Oak

8016

Maun
Mahogany

7016

Antrasit Gri
Anthracite Gray

NOBEL SERİ PLİSE SİNEKLİK / NOBEL SERIES PLEATED FLY SCREEN

İçten Montajlı Internal Mounted

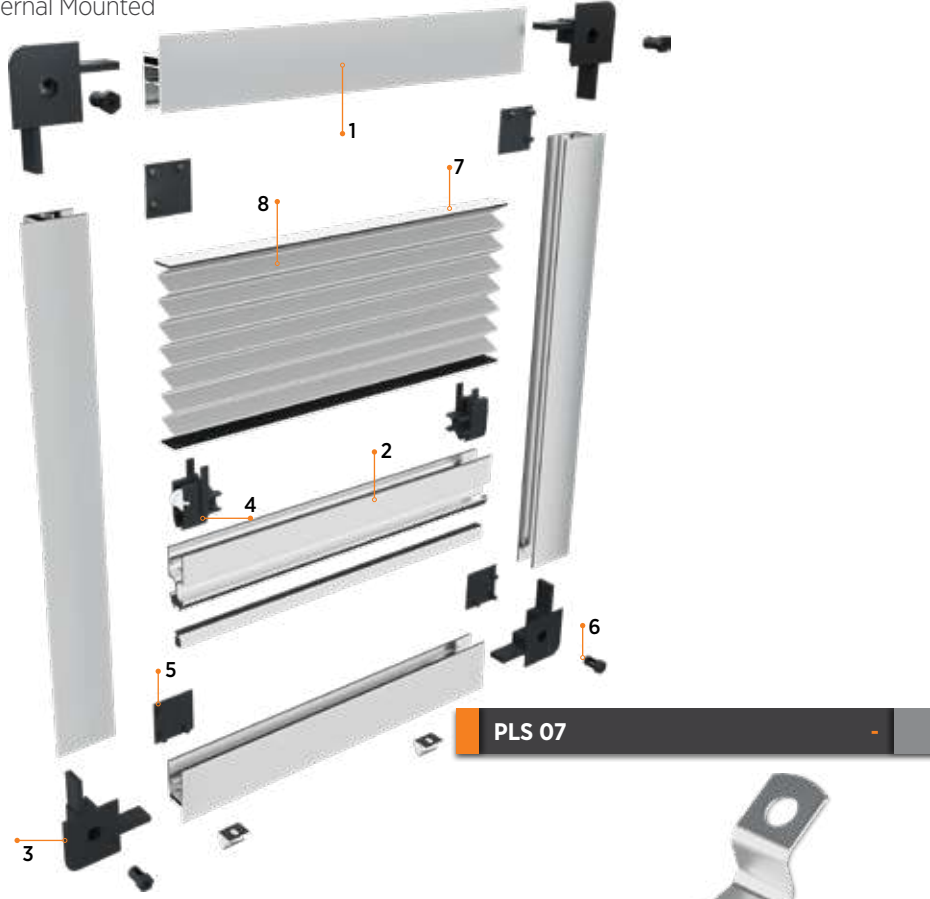

Yeni Ürün New Product

İçten Montaj Set İçeriği / Internal Mounted Set Contents

No	ÜRÜN KODU Product Code	ÜRÜN ADI Product Name
1	337	Nobel İçten Montajlı Kasa Nobel Internal Mounted Case Profile
2	335	Nobel Kanat Profili Nobel Wing
3	PLS 603	Nobel İçten Montajlı Köşe Takozu Nobel Internally Assembled Corner Wedge
4	PLS 122	Nobel Rulman Takımı Nobel Bearing Set
5	PLS 612	Nobel İçten Montajlı Köşe Takozu Kapağı Nobel Internal Mounted Corner Wedge Cover
6	PLS 125	Nobel Köşe Takozu Pimi Nobel Corner Wedge Pin
7	PLS 52	PVC Bantlı Şerit PVC Taped Stripe
8	-	Plise Tül Pleated Tulle

Montaj alanı dar olan Pvc ve panjur sistemleri için kullanılmaktadır. Sistem içerisinden kolay ve hızlı bir şekilde montajlanabilmektedir. İhtiyaç halinde sökülüp takılabileme imkanı sunar.

It is used for PVC and shutter systems with narrow mounting areas. It can be assembled easily and quickly within the system. It offers the possibility to be disassembled and mounted when needed.

PLS 07



Nobel Seri Dıştan Montajlı Metal Klips Nobel Serial Externally Mounted Metal Cleps

Paket İçi Adet Quantity Per Package	500	Koli İçi Adet Quantity Per Box	500
--	-----	-----------------------------------	-----

PLS 06



Nobel Seri İçten Montajlı Metal Klips Nobel Serial Internally Mounted Metal Cleps

Paket İçi Adet Quantity Per Package	500	Koli İçi Adet Quantity Per Box	500
--	-----	-----------------------------------	-----

335



Nobel Kanat Profili Nobel Wing Profile

Paket İçi Adet Quantity Per Package	10	Gramajı Weight	0,345 kg/m
--	----	-------------------	------------

337



Nobel İçten Montajlı Kasa Profili Nobel Internal Mounted Case Profile

Paket İçi Adet Quantity Per Package	10	Gramajı Weight	0,338 kg/m
--	----	-------------------	------------

AKS 20
AKS 21

Beyaz / White
Siyah / Black

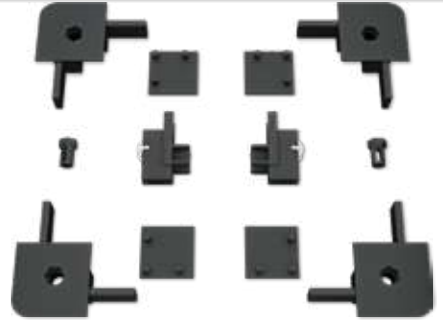

Nobel İçten Montajlı Aksesuar Seti Nobel Internal Mounted Accessory Set

Koli İçi Adet Quantity Per Box	100 Set	Renk Color	<input type="checkbox"/> <input type="checkbox"/>
-----------------------------------	---------	---------------	---

Alüminyum Renk Seçeneği Aluminum Color Options

9016

Beyaz
White



Eloksal Boyalı
Anodized Painted



Bronz Boyalı
Bronze Painted

8003

Altın Meşe
Golden Oak

8016

Maun
Mahogany

7016

Antrasit Gri
Anthracite Gray

SLIM SERİ İÇTEN MONTAJLI PLİSE SİNEKLİK / SLIM SERIES INTERNAL MOUNTED PLAIT FLY SCREEN



Slim İçten Geçmeli Sineklik Profil
Slim Internal Mounted Fly Screen Profile

Paket İçi Adet Quantity Per Package	10	Gramajı Weight	0,272 kg/m
--	----	-------------------	------------



Slim Kanat Profil
Slim Wing Profile

Paket İçi Adet Quantity Per Package	10	Gramajı Weight	0,321 kg/m
--	----	-------------------	------------



İçten Montajlı Metal Klips
Internal Mounted Metal Clip

Paket İçi Adet Quantity Per Package	500	Koli İçi Adet Quantity Per Box	500
--	-----	-----------------------------------	-----



İçten Montajlı Plise Köşeden Gergi Aksesuar Seti
Internal Mounted Pleated Corner Tensioner Accessory Set

Koli İçi Adet Quantity Per Box	100 Set	Renk Color	<input type="checkbox"/> <input type="checkbox"/>
-----------------------------------	---------	---------------	---

Aksesuar İçeriği / Accessory Contents

No	ÜRÜN KODU Product Code	ÜRÜN ADI Product Name
1	PLS 503	4 Adet - Köşe Takoza 4 Pices - Corner Wedge
2	PLS 112	2 Adet - Rulman Takımı 2 Pices - Bearing Set
3	PLS 115	2 Adet - Köşe Takoza Pimi 2 Pices - Corner Wedge Pin
4	PLS 550	10 Adet - Delikli Klips 10 Pices - Hole Clip

ÖZELLİKLER
PROPERTIES

İçten Takılabilen Plise Sineklik;
Internal Mountable Pleated Flyscreen;

Pencere önünde engel olan yerlerde (korkuluk, panjur, çiçeklik, vb.) kullanılır.

Used in areas where there are obstacles in front of windows (railings, window shades, flower beds, etc.).

Yüksek katlarda sinekliğin dışarı açılmasını istemediğiniz durumlarda,

In cases where you don't want the fly screen to be opened on higher floors to the exterior,

Yüksek katlarda sinekliğin dışarı açılmasını istemediğiniz durumlarda, montaj için pencere kasasına herhangi bir vida ve atılmasını istemediğiniz durumlarda.

On high floors when you don't want the fly screen to open out and when you don't want to have any screws to the window frame for mounting.

Bütün olumsuzlukları ortadan kaldıran sineklik sistemidir.

It is a flyscreen systems which eliminates all the problems.

İçten takılabilen sineklik, sabit sineklik olarak vazife görür.

The flyscreens which can be fitted from the inside, serve as fixed flyscreen.

Klips ile takıldığı için montajda vida kullanılmaz. Montajı çok kolaydır.

It is attached with a clip, no screws are used in assembly. It is very easy to assemble.

Kolayca sökülerek temizliği yapılabilir.

It can be easily removed and cleaned.



Alüminyum Renk Seçeneği

Aluminum Color Options

9016

Beyaz
White



Eloksal Boyalı
Anodized Painted



Bronz Boyalı
Bronze Painted

8003

Altın Meşe
Golden Oak

8016

Maun
Mahogany

7016

Antrasit Gri
Anthracite Gray

İÇTEN MONTAJLI SABİT SİNEKLİK / INTERNAL MOUNTED FIXED FLY SCREEN



Kasa Profil Case Profile			
Paket İçi Adet Quantity Per Package	10	Gramajı Weight	0,256 kg/m



Köşe Birleştirici Takoz Corner Combiner Wedge			
Paket İçi Adet Quantity Per Package	100	Koli İçi Adet Quantity Per Box	500



İçten Montajlı Metal Klips Internal Mounted Metal Clip			
Paket İçi Adet Quantity Per Package	500	Koli İçi Adet Quantity Per Box	500

ÖZELLİKLER PROPERTIES

İçten Takılabilen Sineklik; Internal Mountable Flyscreen;

Pencere önünde engel olan yerlerde (korkuluk, panjur, çiçeklik, vb.) kullanılır.
Used in areas where there are obstacles in front of windows (railings, window shades, flower beds, etc.).

Yüksek katlarda sinekliğin dışarı açılmasını istemediğiniz durumlarda,
In cases where you don't want the fly screen to be opened on higher floors to the exterior,

Yüksek katlarda sinekliğin dışarı açılmasını istemediğiniz durumlarda, montaj için pencere kasasına herhangi bir vida ve atılmasını istemediğiniz durumlarda.
On high floors when you don't want the fly screen to open out and when you don't want to have any screws to the window frame for mounting.

Bütün olumsuzlukları ortadan kaldıran sineklik sistemidir.
It is a flyscreen systems which eliminates all the problems.

İçten takılabilen sineklik, sabit sineklik olarak vazife görür.
The flyscreens which can be fitted from the inside, serve as fixed flyscreen.

Klips ile takıldığı için montajda vida kullanılmaz. Montajı çok kolaydır.
It is attached with a clip, no screws are used in assembly. It is very easy to assemble.

Kolayca sökülerek temizliği yapılabilir.
It can be easily removed and cleaned.

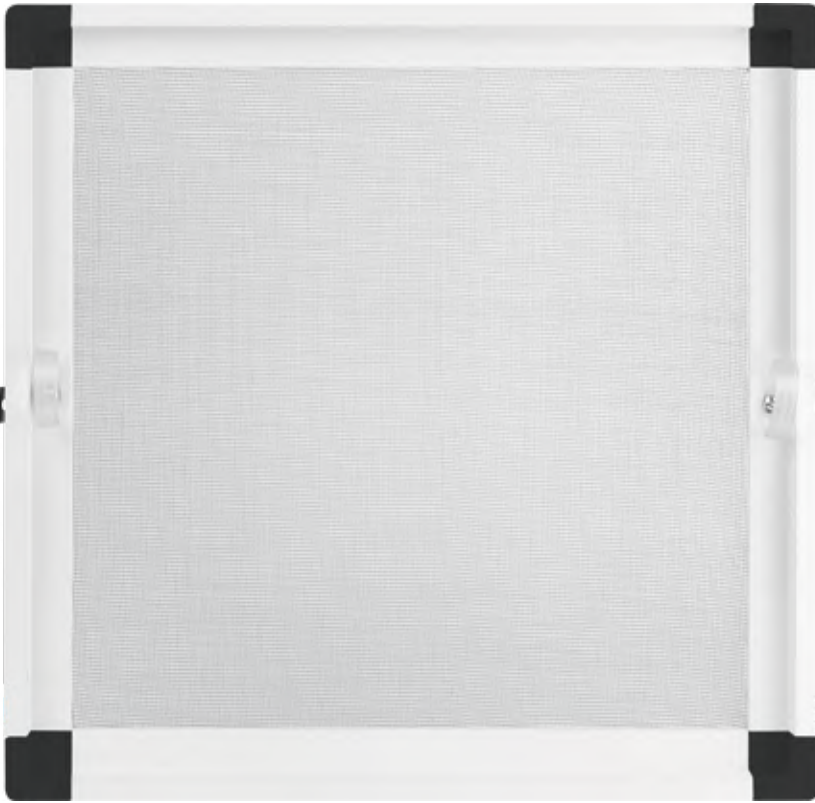

Alüminyum Renk Seçeneği Aluminum Color Options

9016
Beyaz
White

Eloksal Boyalı
Anodized Painted

Bronz Boyalı
Bronze Painted

8003
Altın Meşe
Golden Oak

8016
Maun
Mahogany

7016
Antrasit Gri
Anthracite Gray

ÜRÜN ADI Product Name	ÜRÜN KODU Product Code			Paket m ² Package m ²			KOLİ İÇİ ADET (m ²) Quantity Per Box (m ²)		
	14 mm	16 mm	19 mm	14 mm	16 mm	19 mm	14 mm	16 mm	19 mm
Pile Yüksekliği Plait Height									
190cm Plise Polyester Tül 190cm Plait Polyester Tulle	190-14 P	190-16 P	190-19 P	49 m ²	57 m ²	68 m ²	294 m ²	285 m ²	272 m ²
200cm Plise Polyester Tül 200cm Plait Polyester Tulle	200-14 P	200-16 P	200-19 P	52 m ²	60 m ²	72 m ²	312 m ²	300 m ²	288 m ²
210cm Plise Polyester Tül 210cm Plait Polyester Tulle	210-14 P	210-16 P	210-19 P	55 m ²	63 m ²	76 m ²	330 m ²	315 m ²	304 m ²
220cm Plise Polyester Tül 220cm Plait Polyester Tulle	220-14 P	220-16 P	220-19 P	57 m ²	66 m ²	79 m ²	342 m ²	330 m ²	316 m ²
240cm Plise Polyester Tül 240cm Plait Polyester Tulle	240-14 P	240-16 P	240-19 P	62 m ²	72 m ²	86 m ²	372 m ²	360 m ²	344 m ²
270cm Plise Polyester Tül 270cm Plait Polyester Tulle	270-14 P	270-16 P	270-19 P	70 m ²	81 m ²	97 m ²	420 m ²	405 m ²	388 m ²
300cm Plise Polyester Tül 300cm Plait Polyester Tulle	300-14 P	300-16 P	300-19 P	78 m ²	90 m ²	108 m ²	468 m ²	450 m ²	432 m ²

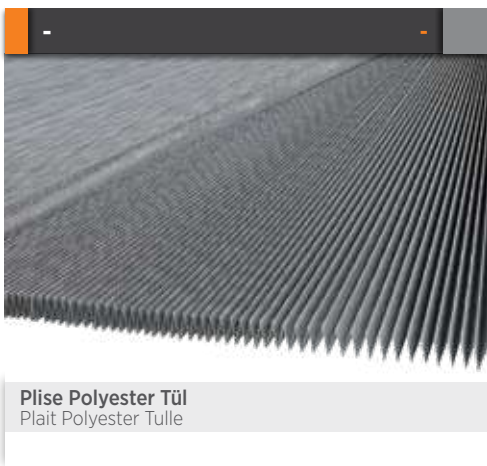

Pile yüksekliği: 14 mm, 16 mm ve 19 mm ölçülerinde stoklarımızda mevcuttur.

A ve B kalitede satışa sunulmaktadır.

Plait height: Available in stock in sizes of 14 mm, 16 mm, and 19 mm.

Available for sale in A and B quality.

ÜRÜN ADI Product Name	ÜRÜN KODU Product Code		Paket m ² Package m ²		KOLİ İÇİ ADET (m ²) Quantity Per Box (m ²)	
Pile Yüksekliği Plait Height	14 mm	16 mm	14 mm	16 mm	14 mm	16 mm
200cm Plise Fiber Tül 200cm Plait Fiber Tulle	200-14 F	200-16 F	60 m ²	50 m ²	300 m ²	250 m ²
210cm Plise Fiber Tül 210cm Plait Fiber Tulle	-	210-16 F	-	52,5 m ²	-	262,5 m ²
220cm Plise Fiber Tül 220cm Plait Fiber Tulle	220-14 F	220-16 F	66 m ²	55 m ²	330 m ²	275 m ²
240cm Plise Fiber Tül 240cm Plait Fiber Tulle	240-14 F	240-16 F	72 m ²	60 m ²	360 m ²	300 m ²
270cm Plise Fiber Tül 270cm Plait Fiber Tulle	270-14 F	270-16 F	81 m ²	67,5 m ²	405 m ²	337,5 m ²
300cm Plise Fiber Tül 300cm Plait Fiber Tulle	300-14 F	300-16 F	90 m ²	75 m ²	450 m ²	375 m ²

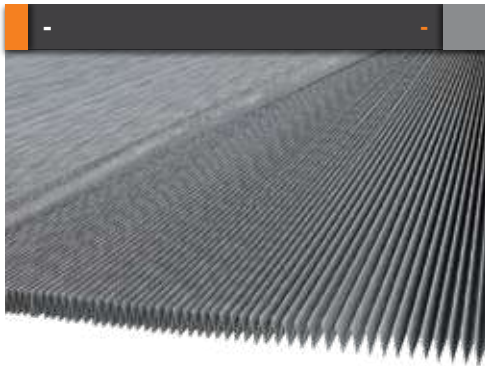

Plise Fiber Tül
Plait Fiber Tulle

Pile yüksekliği: 14 mm ve 16 mm ölçülerinde stoklarımızda mevcuttur.

Plait height: Available in stock in sizes of 14 mm and 16 mm.

PLS 11-4



Kuş Gözü (Metal) 4 mm
Rivet (Metal) 4 mm

Koli İçi Adet Quantity Per Box	5.000
-----------------------------------	-------

PLS 11-5



Kuş Gözü (Metal) - 5 mm
Rivet (Metal) - 5 mm

Koli İçi Adet Quantity Per Box	5.000
-----------------------------------	-------

PLS 12



Plise İpi
Pleat Yarn

Paket İçi Adet Quantity Per Package	1 Top * 500 m	Koli İçi Adet Quantity Per Box	12
--	---------------	-----------------------------------	----

PLS 52



PVC Bantlı Şerit 12/13 mm
PVC Taped Stripe 12/13 mm

Paket İçi Adet Quantity Per Package	1 Top * 500 m	Koli İçi Adet Quantity Per Box	10
--	---------------	-----------------------------------	----

PLS 50



PVC Bantlı Şerit 16 mm
PVC Taped Stripe 16 mm

Paket İçi Adet Quantity Per Package	1 Top * 500 m	Koli İçi Adet Quantity Per Box	10
--	---------------	-----------------------------------	----

PLS 51



PVC Bantlı Şerit 18/19 mm
PVC Taped Stripe 18/19 mm

Paket İçi Adet Quantity Per Package	1 Top * 500 m	Koli İçi Adet Quantity Per Box	10
--	---------------	-----------------------------------	----

PLS 14



PVC Siyah Şerit
PVC Black Stripe

Paket İçi Adet Quantity Per Package	1 Top * 100 m	Koli İçi Adet Quantity Per Box	10
--	---------------	-----------------------------------	----

PLS 14-A



PVC Yeşil Şerit 16mm
PVC Green Stripe 16mm

Paket İçi Adet Quantity Per Package	1 Top * 1.400 m
--	-----------------

PLS 14-B



PVC Yeşil Şerit 19mm
PVC Green Stripe 19mm

Paket İçi Adet Quantity Per Package	1 Top * 1.000 m
--	-----------------

PLS 45



Premium PVC Bantlı Şerit 12/13 mm
Premium PVC Taped Stripe 12/13 mm

Paket İçi Adet Quantity Per Package	1 Top * 500 m	Koli İçi Adet Quantity Per Box	10
--	---------------	-----------------------------------	----

PLS 46



Premium PVC Bantlı Şerit 16 mm
Premium PVC Taped Stripe 16 mm

Paket İçi Adet Quantity Per Package	1 Top * 500 m	Koli İçi Adet Quantity Per Box	10
--	---------------	-----------------------------------	----

PLS 47



Premium PVC Bantlı Şerit 18/19 mm
Premium PVC Taped Stripe 18/19 mm

Paket İçi Adet Quantity Per Package	1 Top * 500 m	Koli İçi Adet Quantity Per Box	10
--	---------------	-----------------------------------	----

PLS 53



Çift Taraflı Bant
Double Sided Band

Paket İçi Adet
Quantity Per Package

1 Top * 50 m

PLS 22



Mıknatıs
Magnet

Paket İçi Adet
Quantity Per Package

16 kg

Koli İçi Adet
Quantity Per Box

≈175 m

PRD 31



Kumaş Delme Makinesi
Fabric Punching Machine



PLATİN SÜRME SİNEKLİK / PLATIN SLIDING FLY SCREEN

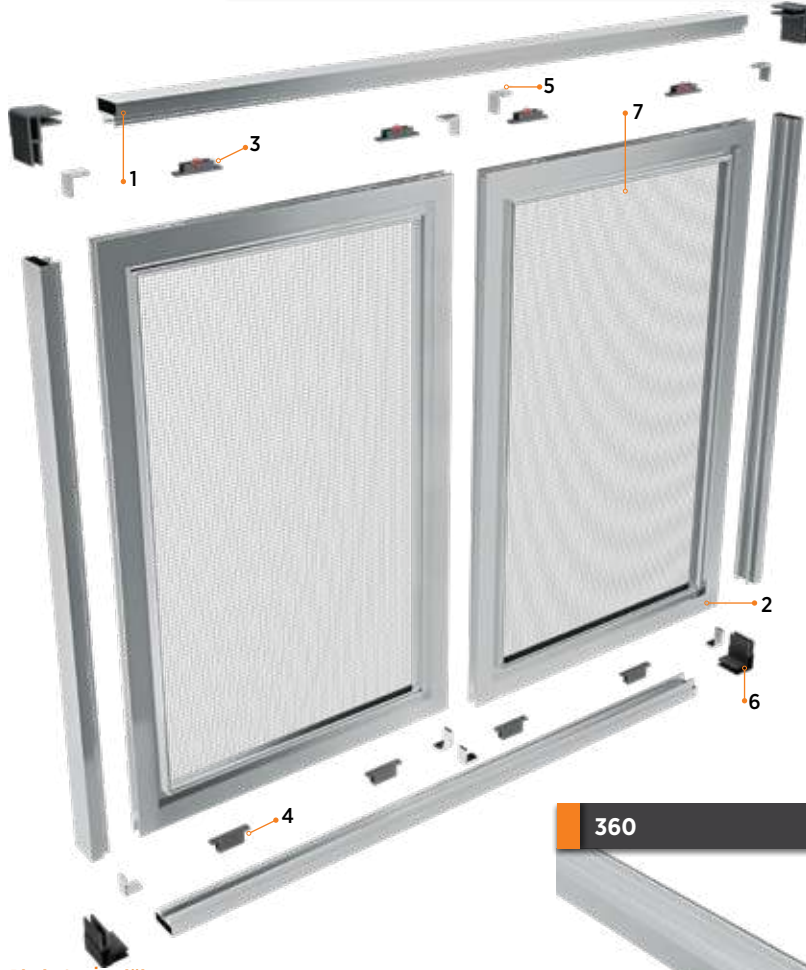

Platin Set İçeriği / Platin Set Contents

No	ÜRÜN KODU Product Code	ÜRÜN ADI Product Name
1	321/322	Kasa Profil Case Profile
2	323	Kanat Profil Wing Profile
3	PLT 05	Denge Plastiği Balance Plastic
4	PLT 04	Rulmanlı Teker Bearing Wheel
5	PLT 03	Alüminyum Köşe Takozu Aluminum Corner Wedge
6	PLT 02	Plastik Köşe Takozu Plastic Corner Wedge
7	-	Sineklik Tülü Flynet Tulle



Platin Sürme Sineklik Tekli Kasa Platin Single Case			
Paket İçi Adet Quantity Per Package	8	Gramajı Weight	0,352 kg/m



Platin Tekli Slim Kasa Profil Platin Slim Single Case Profil			
Paket İçi Adet Quantity Per Package	8	Gramajı Weight	0,306 kg/m



Platin Çiftli Kasa Platin Single Case			
Paket İçi Adet Quantity Per Package	6	Gramajı Weight	0,455 kg/m

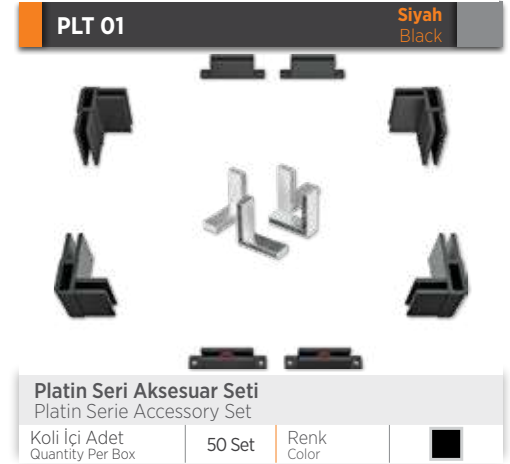

Platin Seri Aksesuar Seti
Platin Serie Accessory Set

Koli İçi Adet Quantity Per Box	50 Set	Renk Color	Siyah Black
-----------------------------------	--------	---------------	----------------



Platin Seri Aksesuar Seti
Platin Serie Accessory Set

Koli İçi Adet Quantity Per Box	50 Set	Renk Color	Siyah Black
-----------------------------------	--------	---------------	----------------



Platin Sürme Sineklik Kanat Profil Platin Wing Profile			
Paket İçi Adet Quantity Per Package	10	Gramajı Weight	0,506 kg/m

Alüminyum Renk Seçeneği
Aluminum Color Options

9016
Beyaz
White

Eloksal Boyalı
Anodized Painted

Bronz Boyalı
Bronze Painted

8003
Altın Meşe
Golden Oak

8016
Maun
Mahogany

7016
Antrasit Gri
Anthracite Gray

AYKİM SÜRME SİNEKLİK / AYKİM SLIDING FLY SCREEN

PRS 37

Beyaz / Altın Meşe / Siyah
White / Golden oak / Black



Aykim Makarasız Köşe
Aykim Corner whitout Roll

Paket İçi Adet Quantity Per Package	50	Koli İçi Adet Quantity Per Box	500
--	----	-----------------------------------	-----

PRS 36

Beyaz / Altın Meşe / Siyah
White / Golden oak / Black



Aykim Makaralı Köşe
Aykim Corner whit Roll

Paket İçi Adet Quantity Per Package	50	Koli İçi Adet Quantity Per Box	500
--	----	-----------------------------------	-----

PRS 38

Beyaz / Altın Meşe / Siyah
White / Golden oak / Black



Aykim Kasa Takozu
Aykim Wedge

Paket İçi Adet Quantity Per Package	100	Koli İçi Adet Quantity Per Box	1.000
--	-----	-----------------------------------	-------

309



Aykim Kasa Profil
Aykim Case Profile

Paket İçi Adet Quantity Per Package	8	Gramajı Weight	0,374 kg/m
--	---	-------------------	------------

310



Aykim Kanat Profil
Aykim Wing profile

Paket İçi Adet Quantity Per Package	10	Gramajı Weight	0,315 kg/m
--	----	-------------------	------------

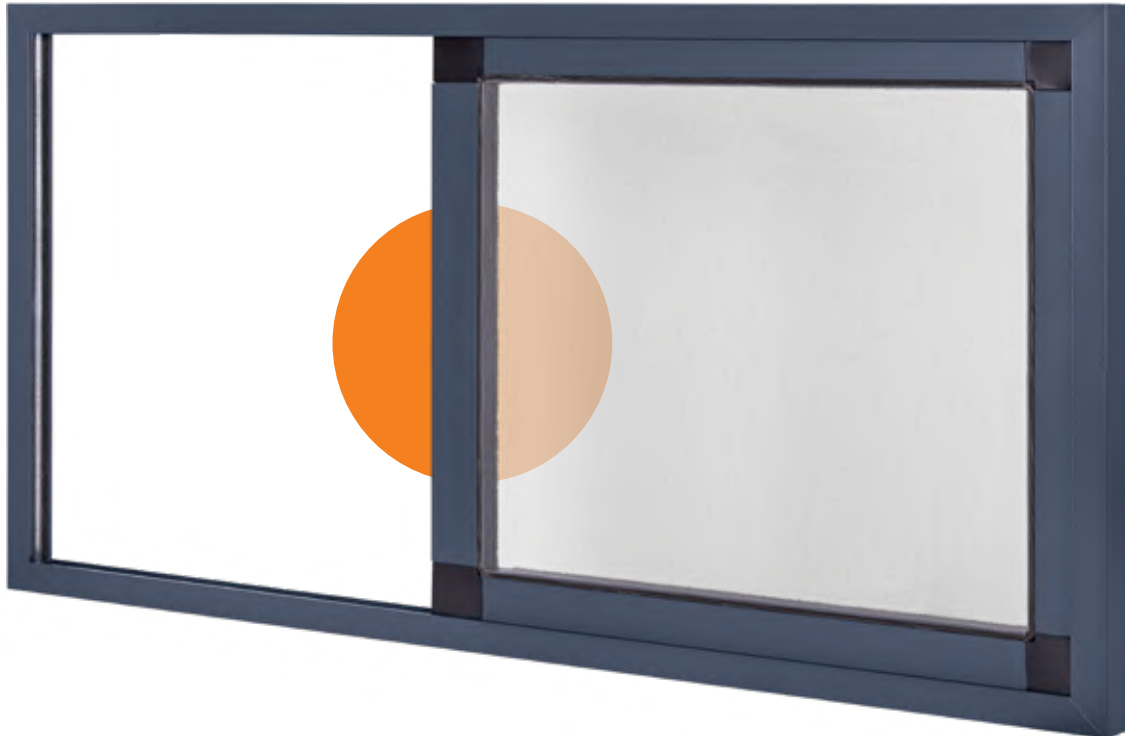

Alüminyum Renk Seçeneği

Aluminum Color Options

9016

Beyaz
White



Eloksoal Boyalı
Anodized Painted



Bronz Boyalı
Bronze Painted

8003

Altın Meşe
Golden Oak

8016

Maun
Mahogany

7016

Antrasit Gri
Anthracite Gray



Stor Set İçeriği / Stor Set Contents

No	ÜRÜN KODU Product Code	ÜRÜN ADI Product Name
1	409	Üst Kasa Profil Upper Case Profile
2	410	Yan Kasa Profil Side Case Profile
3	411	Alt Kasa Profil Bottom Case Profile
4	407	Kanat Profil Wing Profile
5	408	Tül Boru Profil Tulle Pipe Profile
6	-	Stor Tül Stor Tulle
7	STR 100	Fren Köşe Plastiği Brake Corner Plastic
8	STR 101	Yay Köşe Plastiği Spring Corner Plastic
9	-	Yay Spring
10	STR 102	Yay Kapama Boru Plastiği Spring Closure Pipe Plastic
11	STR 103	Yay Sabitleme Plastiği Spring Fixing Plastic
12	STR 104	Kasa Birleştirme Plastiği Case Joining Plastic
13	STR 105	Kulp Handle
14	STR 106	İp Tutma Aparatı Rope Holder
15	STR 107	Kanat Kapağı Wing Cover
16	STR 02	Fren Sistemi Brake System
17	Fitil 24	Kıl Fitil Brush Seal



STR 01

Beyaz / Siyah
White / Black



Stor Sineklik Aksesuar Seti
Stor Fly Screen Accessory Set

Paket İçi Adet Quantity Per Package	1 Set	Koli İçi Adet Quantity Per Box	50 Set
--	-------	-----------------------------------	--------

STR 02

Siyah
Black



Stor Sineklik Fren Sistemi
Stor Fly Screen Brake Profile

Paket İçi Adet Quantity Per Package	50	Koli İçi Adet Quantity Per Box	50
--	----	-----------------------------------	----

Fitol 24



67x650 Kıl Fitol
67x650 Brush Seal

Paket İçi Adet Quantity Per Package	350 m	Koli İçi Adet Quantity Per Box	1.400 m
--	-------	-----------------------------------	---------

STR 03



Stor Kaset 160 cm
Cassette 160 cm

Paket İçi Adet Quantity Per Package	1 Set
--	-------

410



Stor Sineklik Yan Kasa Profil
Stor Fly Screen Side Case Profile

Paket İçi Adet Quantity Per Package	6	Gramajı Weight	0,413 kg/m
--	---	-------------------	------------

411



Stor Sineklik Alt Kasa Profil
Stor Fly Screen Bottom Case Profile

Paket İçi Adet Quantity Per Package	6	Gramajı Weight	0,318 kg/m
--	---	-------------------	------------



- Yay mekanizmalı ve geri sarmalı olarak tasarlandı.
- Alt kasa aynı zamanda sineklik ekranını kilitleyecek şekilde tırnaklı olarak tasarlandı.
- Alüminyum kanat alt kasa tırnaklarından ayrıldığı anda sarım profili içerisindeki kurulmuş olan yay, sineklik tülünü üst kasa içerisinde geri sarım yaparak toplar. Bu toplama esnasında hidrolik fren devreye girer. Böylece sarım yavaş ve düzgün olur.
- Sinekliğin çerçevesini oluşturan profiller aynı zamanda kasa profili olarak dizayn edildi. Üst kasa, yan kasa ve alt kasa profilleri 4 adet takoz ile birleştirildi.
- Sistem kurulur. Köşe takozlarındaki kanallardan yapılan vidalama ile sistem yerine montajlanır. İşte bu kadar basit!

- It is designed with a spring mechanism and rewind.
- The bottom case is also designed with tabs to lock the fly screen.
- When the aluminum wing is separated from the lower case tabs, the spring installed in the winding profile collects the fly net in the upper case by rewinding. During this collection, the hydraulic brake is activated. Thus, the winding is slow and smooth.
- The profiles forming the frame of the fly screen were also designed as frame profiles. Upper case, side case, and lower case profiles were combined with 4 wedges.
- The system is easily installed. The installation is accomplished by screwing through the channels in the corner wedges. That's all it takes!

Alüminyum Renk Seçeneği

Aluminum Color Options

9016

Beyaz
White



Eloksal Boyalı
Anodized Painted



Bronz Boyalı
Bronze Painted

8003

Altın Meşe
Golden Oak

8016

Maun
Mahogany

7016

Antrasit Gri
Anthracite Gray



Ahşap
Wooden

PRS 01



17x25 Sineklik Köşe Takozu
17x25 Flynet Corner Wedge

Paket İçi Adet Quantity Per Package	100	Koli İçi Adet Quantity Per Box	1.000
--	-----	-----------------------------------	-------

PRS 02



17x25 Sineklik Mentеше (Plastik Pimli)
17x25 Flynet Plastic Hinge (with Plastic Pin)

Paket İçi Adet Quantity Per Package	100	Koli İçi Adet Quantity Per Box	2.000
--	-----	-----------------------------------	-------

PRS 04



17x25 Sineklik Tutamak
17x25 Flynet Handle

Paket İçi Adet Quantity Per Package	100	Koli İçi Adet Quantity Per Box	1.500
--	-----	-----------------------------------	-------

PRS 05



17x25 Sineklik Çıtçıt
17x25 Flynet Gripper

Paket İçi Adet Quantity Per Package	100	Koli İçi Adet Quantity Per Box	2.000
--	-----	-----------------------------------	-------

PRS 06



17x25 Sineklik Bağlama Pabucu
17x25 Flynet Fastening Plate

Paket İçi Adet Quantity Per Package	50	Koli İçi Adet Quantity Per Box	500
--	----	-----------------------------------	-----

PRS 07



10x20 Sineklik Köşe Takozu
10x20 Flynet Corner Wedge

Paket İçi Adet Quantity Per Package	100	Koli İçi Adet Quantity Per Box	2.500
--	-----	-----------------------------------	-------

PRS 08



10x20 Sineklik Mentеше (Plastik Pimli)
10x20 Flynet Plastic Hinge (with Plastic Pin)

Paket İçi Adet Quantity Per Package	100	Koli İçi Adet Quantity Per Box	2.000
--	-----	-----------------------------------	-------

PRS 10



10x20 Sineklik Tutamak
10x20 Flynet Handle

Paket İçi Adet Quantity Per Package	100	Koli İçi Adet Quantity Per Box	3.000
--	-----	-----------------------------------	-------

PRS 11



10x20 Sineklik Çıtçıt
10x20 Flynet Gripper

Paket İçi Adet Quantity Per Package	100	Koli İçi Adet Quantity Per Box	3.000
--	-----	-----------------------------------	-------

PRS 12

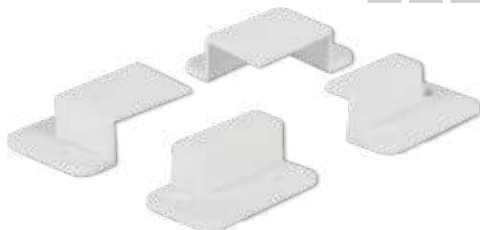

10x20 Sineklik Bağlama Pabucu
10x20 Flynet Fastening Plate

Paket İçi Adet Quantity Per Package	50	Koli İçi Adet Quantity Per Box	500
--	----	-----------------------------------	-----

PRS 13



10x20 Sineklik Tutma Halkası
10x20 Flynet Holding Ring

Paket İçi Adet Quantity Per Package	100	Koli İçi Adet Quantity Per Box	2.500
--	-----	-----------------------------------	-------

PRS 14



10x20 Sineklik Tutma Halkası Altı
10x20 Flynet Holding Ring Bottom Part

Paket İçi Adet Quantity Per Package	100	Koli İçi Adet Quantity Per Box	2.500
--	-----	-----------------------------------	-------

PRS 15



20x40 Sineklik Köşe Takozu
20x40 Flynet Corner Wedge

Paket İçi Adet Quantity Per Package	50	Koli İçi Adet Quantity Per Box	600
--	----	-----------------------------------	-----

PRS 16



10x20 Sineklik Köşe Takozu 45°
10x20 Flynet Corner Wedge 45°

Paket İçi Adet Quantity Per Package	100	Koli İçi Adet Quantity Per Box	2.000
--	-----	-----------------------------------	-------

PRS 17



17x25 Sineklik Köşe Takozu 45°
17x25 Flynet Corner Wedge 45°

Paket İçi Adet Quantity Per Package	100	Koli İçi Adet Quantity Per Box	600
--	-----	-----------------------------------	-----

PRS 26



Sineklik Köşe Mukavemet Takozu
Flynet Corner Strength Wedge

Paket İçi Adet Quantity Per Package	100	Koli İçi Adet Quantity Per Box	1.500
--	-----	-----------------------------------	-------

PRS 24



Plastik "D" Kol
Plastic "D" Handle

Paket İçi Adet Quantity Per Package	50	Koli İçi Adet Quantity Per Box	600
--	----	-----------------------------------	-----

PRS 30



Plastik "C" Kol
Plastic "C" Handle

Paket İçi Adet Quantity Per Package	100	Koli İçi Adet Quantity Per Box	1.500
--	-----	-----------------------------------	-------

PRS 27

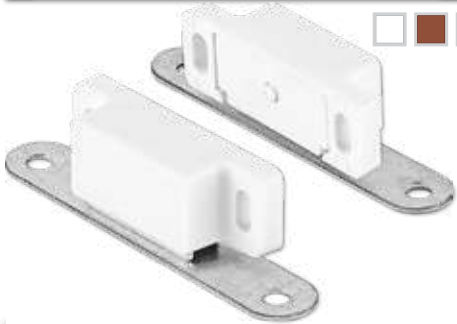

Mıknatıslı Çıtçı
Gripper with Magnet

Paket İçi Adet Quantity Per Package	100	Koli İçi Adet Quantity Per Box	500
--	-----	-----------------------------------	-----

PRS 19



Sineklik Fitolü (Beyaz)
Flynet Seal (White)

Paket İçi Adet Quantity Per Package	15	Koli İçi Adet Quantity Per Box	1.500 m
--	----	-----------------------------------	---------

PRS 29



Sineklik Takma Aparatı 3'lü
Triple Flynet Mounting Apparatus

Paket İçi Adet Quantity Per Package	20	Koli İçi Adet Quantity Per Box	100
--	----	-----------------------------------	-----

PRS 37



Aykim Makarasız Köşe
Aykim Corner without Pulley

Paket İçi Adet Quantity Per Package	50	Koli İçi Adet Quantity Per Box	500
--	----	-----------------------------------	-----

PRS 36



Aykim Makaralı Köşe
Aykim Corner with Pulley

Paket İçi Adet Quantity Per Package	50	Koli İçi Adet Quantity Per Box	500
--	----	-----------------------------------	-----

PRS 38



Aykim Kasa Takozu
Aykim Wedge

Paket İçi Adet Quantity Per Package	100	Koli İçi Adet Quantity Per Box	1.000
--	-----	-----------------------------------	-------

PRS 25



Cam Küreği
Glass Paddle

Koli İçi Adet
Quantity Per Box

150

PRS 20



Plastik Çarpma
Plastic Crash Barrier

Koli İçi Adet
Quantity Per Box

500

ZZ 29



Emniyet Kilidi
Safety Lock

Koli İçi Adet
Quantity Per Box

150

ZZ 32



Pimli Emniyet Kilidi
Safety Lock with Pin

Koli İçi Adet
Quantity Per Box

150

ZZ 39



Halatlı Emniyet Kilidi
Safety Lock with Rope

Koli İçi Adet
Quantity Per Box

100

PSS 8



Paslanmaz Lüks Teker
Stainless Luxury Wheel

Koli İçi Adet
Quantity Per Box

200

ZZ 26



Teflon Bant
Teflon Tape

Koli İçi Adet
Quantity Per Box

50m

Cam Takozları

Glass Wedges



ÜRÜN ADI

Product Name

ÜRÜN KODU

Product Code

KOLI İÇİ ADET

Quantity Per Box

2mmx20mmx80mm

ACT 6

20.000

5mmx20mmx80mm

ACT 7

12.000

5mmx25mmx80mm

ACT 9

10.000

5mmx28mmx80mm

ACT 10

10.000

5mmx32mmx80mm

ACT 11

5.000

DESTEK SACLI 90 mm PLASTİK KAPI MENTEŞESİ

90 mm Plastic Door Hinge with Support Sheet

ÜRÜN ADI Product Name	ÜRÜN KODU Product Code	KOLİ İÇİ ADET Quantity Per Box
Beyaz 9016 / White 9016	SM 90 9016	150
Altın Meşe 8003 / Golden Oak 8003	SM 90 8003	150
Maun 8016 / Mahogany 8016	SM 90 8016	150
Antrasit Gri 7016 / Anthracite Gray 7016	SM 90 7016	150
Siyah 9005 / Black 9005	SM 90 9005	150



ÖZELLİKLER

PROPERTIES

1,2 mm galvaniz kaplamalı çelik sac ile desteklenmiştir.
Supported by 1,2 mm galvanized steel sheet.

İç yapısındaki sac desteği sayesinde zamak menteşelere göre taşıma kapasitesi daha yüksektir.
Thanks to the sheet metal support in the internal structure, a higher carrying capacity is obtained, compared to the zamak hinges.

Kanatlarda sarkma problemini tamamen ortadan kaldırır.
It completely eliminates the problem of sagging in the wings.



1,2 mm galvaniz kaplamalı
çelik sac (90 mm)

1,2 mm galvanized
steel sheet (90 mm)

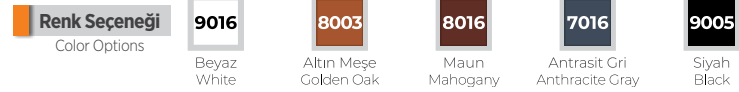

DESTEK SACLI 75 mm PLASTİK PENCERE MENTEŞESİ

75 mm Plastic Window Hinge with Support Sheet

ÜRÜN ADI Product Name	ÜRÜN KODU Product Code	KOLİ İÇİ ADET Quantity Per Box
Beyaz 9016 / White 9016	SM 75 9016	150
Altın Meşe 8003 / Golden Oak 8003	SM 75 8003	150
Maun 8016 / Mahogany 8016	SM 75 8016	150
Antrasit Gri 7016 / Anthracite Gray 7016	SM 75 7016	150
Siyah 9005 / Black 9005	SM 75 9005	150



ÖZELLİKLER

PROPERTIES

1,2 mm galvaniz kaplamalı çelik sac ile desteklenmiştir.
Supported by 1,2 mm galvanized steel sheet.

İç yapısındaki sac desteği sayesinde zamak menteşelere göre taşıma kapasitesi daha yüksektir.
Thanks to the sheet metal support in the internal structure, a higher carrying capacity is obtained, compared to the zamak hinges.

Kanatlarda sarkma problemini tamamen ortadan kaldırır.
It completely eliminates the problem of sagging in the wings.



1,2 mm galvaniz kaplamalı
çelik sac (75 mm)

1,2 mm galvanized
steel sheet (75 mm)



Gold Baza Profil
Gold Base Profile

Paket İçi Adet Quantity Per Package	3	Gramajı Weight	0,717 kg/m
--	---	-------------------	------------



Firtına Baza Profil
Firtına Base Profile

Paket İçi Adet Quantity Per Package	3	Gramajı Weight	0,730 kg/m
--	---	-------------------	------------



Oluklu Kasa Profil
Corrugated Case Profile

Paket İçi Adet Quantity Per Package	3	Gramajı Weight	1,396 kg/m
--	---	-------------------	------------



Düz Kasa Profil
Flat Case Profile

Paket İçi Adet Quantity Per Package	3	Gramajı Weight	1,355 kg/m
--	---	-------------------	------------



Oluklu Büyük Kasa Profil
Corrugated Big Case Profile

Paket İçi Adet Quantity Per Package	3	Gramajı Weight	1,611 kg/m
--	---	-------------------	------------



Büyük Düz Kasa Profil
Big Flat Case Profile

Paket İçi Adet Quantity Per Package	3	Gramajı Weight	1,570 kg/m
--	---	-------------------	------------

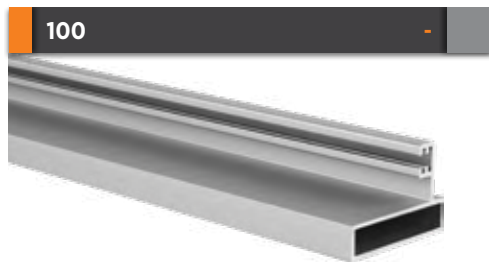

Dar Yan Dikme Profil
Thin Side Column Profile

Paket İçi Adet Quantity Per Package	6	Gramajı Weight	0,441 kg/m
--	---	-------------------	------------



Geniş Yan Dikme Profil
Thick Side Column Profile

Paket İçi Adet Quantity Per Package	6	Gramajı Weight	0,457 kg/m
--	---	-------------------	------------



Stor Profil
Stor Profile

Paket İçi Adet Quantity Per Package	3	Gramajı Weight	1,062 kg/m
--	---	-------------------	------------



8 mm İspanyolet Profil
8 mm Espagnolette Profile

Paket İçi Adet Quantity Per Package	4	Gramajı Weight	0,517 kg/m
--	---	-------------------	------------



8 mm İspanyolet Profil Karşılığı
8 mm Espagnolette Combination Profile

Paket İçi Adet Quantity Per Package	8	Gramajı Weight	0,343 kg/m
--	---	-------------------	------------

8mm CAM BALKON FITİL PROFİLLERİ

8mm Balcony Wick Profiles



Büyük D Fitol
Big D Wick

Paket İçi Adet Quantity Per Package	10	Gramajı Weight	0,247 kg/m
--	----	-------------------	------------



Küçük D Fitol
Small D Wick

Paket İçi Adet Quantity Per Package	10	Gramajı Weight	0,167 kg/m
--	----	-------------------	------------



Küçük h Fitol
Small h Wick

Paket İçi Adet Quantity Per Package	20	Gramajı Weight	0,116 kg/m
--	----	-------------------	------------



Orta H Fitol
Medium H Wick

Paket İçi Adet Quantity Per Package	10	Gramajı Weight	0,150 kg/m
--	----	-------------------	------------



Büyük H Fitol
Big H Wick

Paket İçi Adet Quantity Per Package	20	Gramajı Weight	0,214 kg/m
--	----	-------------------	------------

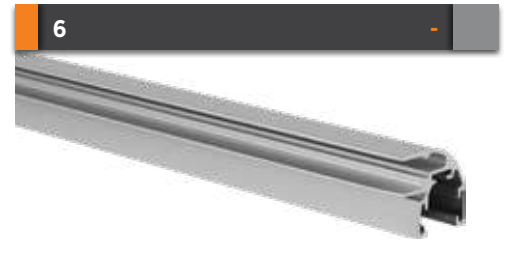

Köşe Dönüş Fitol
Corner Return Wick

Paket İçi Adet Quantity Per Package	10	Gramajı Weight	0,276 kg/m
--	----	-------------------	------------



Alüminyum Renk Seçeneği

Aluminum Color Options

9016

Beyaz
White

E6

Mat Eloksal
Matt Anodized

M0

Mat Bronz
Matt Bronze

P0

Parlak Bronz
Gloss Bronze

8003

Altın Meşe
Golden Oak

8016

Maun
Mahogany

7016

Antrasit Gri
Anthracite Gray

Eloksal Boyalı
Anodized Painted

Bronz Boyalı
Bronze Painted

PRC 01

Gold Dıştan Geçmeli Sistem



Düz Baza Kapak Sağ - Sol
Flat Base Cover Left - Right

Paket İçi Adet Quantity Per Package	150	Koli İçi Adet Quantity Per Box	1.500
--	-----	-----------------------------------	-------

PRC 02

Gold Dıştan Geçmeli Sistem



Gold Radius Kapak
Gold Radius Cover

Paket İçi Adet Quantity Per Package	100	Koli İçi Adet Quantity Per Box	600
--	-----	-----------------------------------	-----

PRC 05

Gold Dıştan Geçmeli Sistem



90° Alt Kapak Sağ - Sol
90° Bottom Cover Right-Left

Paket İçi Adet Quantity Per Package	100	Koli İçi Adet Quantity Per Box	400
--	-----	-----------------------------------	-----

PRC 06

Gold Dıştan Geçmeli Sistem



90° Üst Kapak Sağ - Sol
90° Top Cover Right-Left

Paket İçi Adet Quantity Per Package	100	Koli İçi Adet Quantity Per Box	400
--	-----	-----------------------------------	-----

PRC 09

Gold Dıştan Geçmeli Sistem



Baza Bitiş Kapak Sağ - Sol
Base Side Column Cover Right-Left

Paket İçi Adet Quantity Per Package	100	Koli İçi Adet Quantity Per Box	800
--	-----	-----------------------------------	-----

PRC 11

Gold Dıştan Geçmeli Sistem



22,5° Alt Kapak Sağ - Sol
22,5° Bottom Cover Right-Left

Paket İçi Adet Quantity Per Package	100	Koli İçi Adet Quantity Per Box	800
--	-----	-----------------------------------	-----

PRC 12

Gold Dıştan Geçmeli Sistem



22,5° Üst Kapak Sağ - Sol
22,5° Top Cover Right-Left

Paket İçi Adet Quantity Per Package	100	Koli İçi Adet Quantity Per Box	800
--	-----	-----------------------------------	-----

PRC 01-PİM

Gold Pimli Sistem



Düz Baza Kapak Pimli Sağ-Sol
Base Intermediate Cover Flat with Pin Right-Left

Paket İçi Adet Quantity Per Package	150	Koli İçi Adet Quantity Per Box	1.500
--	-----	-----------------------------------	-------

PRC 05-PİM

Gold Pimli Sistem



90° Alt Kapak Pimli Sağ - Sol
90° Bottom Cover with Pin Right-Left

Paket İçi Adet Quantity Per Package	100	Koli İçi Adet Quantity Per Box	400
--	-----	-----------------------------------	-----

PRC 06-PİM

Gold Pimli Sistem



90° Üst Kapak Pimli Sağ - Sol
90° Top Cover with Pin Right-Left

Paket İçi Adet Quantity Per Package	100	Koli İçi Adet Quantity Per Box	400
--	-----	-----------------------------------	-----

PRC 09-PİM

Gold Pimli Sistem



Baza Bitiş Kapak Pimli Sağ - Sol
Base Side Column Cover with Pin Right-Left

Paket İçi Adet Quantity Per Package	100	Koli İçi Adet Quantity Per Box	800
--	-----	-----------------------------------	-----

PRC 11-PİM

Gold Pimli Sistem



22,5° Alt Kapak Pimli Sağ - Sol
22,5° Bottom Cover with Pin Right-Left

Paket İçi Adet Quantity Per Package	100	Koli İçi Adet Quantity Per Box	800
--	-----	-----------------------------------	-----

8mm CAM BALKON AKSESUARLARI

8mm Balcony Glass Accessories

Renk Seçeneği
Color Options

Siyah
Black

process
ALUMINIUM & PVC SYSTEMS

PRC 12-PİM

Gold Pimli Sistem



22,5° Üst Kapak Pimli Sağ - Sol
22,5° Top Cover with Pin Right-Left

Paket İçi Adet Quantity Per Package	100	Koli İçi Adet Quantity Per Box	800
--	-----	-----------------------------------	-----

PRC 44

Fırtına Sistem



Fırtına Düz Baza Kapak Sağ - Sol
Fırtına Base Intermediate Cover Flat Right-Left

Paket İçi Adet Quantity Per Package	150	Koli İçi Adet Quantity Per Box	1.500
--	-----	-----------------------------------	-------

PRC 46

Fırtına Sistem



Fırtına 90° Alt Kapak Sağ - Sol
Fırtına 90° Bottom Cover Right-Left

Paket İçi Adet Quantity Per Package	100	Koli İçi Adet Quantity Per Box	400
--	-----	-----------------------------------	-----

PRC 47

Fırtına Sistem



Fırtına 90° Üst Kapak Sağ - Sol
Fırtına 90° Top Cover Right-Left

Paket İçi Adet Quantity Per Package	100	Koli İçi Adet Quantity Per Box	400
--	-----	-----------------------------------	-----

PRC 48

Fırtına Sistem



Fırtına Baza Bitiş Kapak Sağ - Sol
Fırtına Base Side Column Cover Right-Left

Paket İçi Adet Quantity Per Package	100	Koli İçi Adet Quantity Per Box	800
--	-----	-----------------------------------	-----

PRC 50

Fırtına Sistem



Fırtına 22,5° Alt Kapak Sağ - Sol
Fırtına 22,5° Bottom Cover Right-Left

Paket İçi Adet Quantity Per Package	100	Koli İçi Adet Quantity Per Box	800
--	-----	-----------------------------------	-----

PRC 51

Fırtına Sistem



Fırtına 22,5° Üst Kapak Sağ - Sol
Fırtına 22,5° Top Cover Right-Left

Paket İçi Adet Quantity Per Package	100	Koli İçi Adet Quantity Per Box	800
--	-----	-----------------------------------	-----

PRC 14



Kilitli Metal Teker
Locking Wheel with Stainless Pin (Metal)

Paket İçi Adet Quantity Per Package	250	Koli İçi Adet Quantity Per Box	250
--	-----	-----------------------------------	-----

PRC 13



Düz Metal Teker
Simple Wheel with Stainless Pin (Metal)

Paket İçi Adet Quantity Per Package	250	Koli İçi Adet Quantity Per Box	250
--	-----	-----------------------------------	-----

PRC 82



8 mm İspanyolet Karşılık Aksesuarı
8 mm Espagnolette Return Accessory

Paket İçi Adet Quantity Per Package	250	Koli İçi Adet Quantity Per Box	1.000
--	-----	-----------------------------------	-------

PRC 32



Plastik Zincir
Plastic Bead Rope

Paket İçi Adet Quantity Per Package	200 m	Koli İçi Adet Quantity Per Box	2.400 m
--	-------	-----------------------------------	---------

PRC 33



Plastik Zincir Tutamağı
Plastic Bead Rope Handle

Paket İçi Adet Quantity Per Package	700	Koli İçi Adet Quantity Per Box	700
--	-----	-----------------------------------	-----

PRC 17



Yönlendirici Boynuz
Router

Paket İçi Adet Quantity Per Package	50	Koli İçi Adet Quantity Per Box	300
--	----	-----------------------------------	-----

PRC 18



Kilit
Lock

Paket İçi Adet Quantity Per Package	100	Koli İçi Adet Quantity Per Box	700
--	-----	-----------------------------------	-----

PRC 26



Borulu Stoplama
Stopper

Paket İçi Adet Quantity Per Package	150	Koli İçi Adet Quantity Per Box	150
--	-----	-----------------------------------	-----

PRC 22



Polyemit Lama 4'lü
Guide and Brake for System (4)

Paket İçi Adet Quantity Per Package	200	Koli İçi Adet Quantity Per Box	200
--	-----	-----------------------------------	-----

PRC 23



Polyemit Lama 7'li
Guide and Brake for System (7)

Paket İçi Adet Quantity Per Package	200	Koli İçi Adet Quantity Per Box	200
--	-----	-----------------------------------	-----

PRC 24



Polyemit Lama 10'lü
Guide and Brake for System (10)

Paket İçi Adet Quantity Per Package	100	Koli İçi Adet Quantity Per Box	100
--	-----	-----------------------------------	-----

PRC 20



Teker Çıkış Plastiği U
Outlet Plastics U

Paket İçi Adet Quantity Per Package	100	Koli İçi Adet Quantity Per Box	800
--	-----	-----------------------------------	-----

PRC 79



U Çıkış Plastik Kapağı
Outlet Plastic Cover U

Paket İçi Adet Quantity Per Package	500	Koli İçi Adet Quantity Per Box	500
--	-----	-----------------------------------	-----

PRC 21



Polyemit Lama Tekli
Guide and Brake for System

Paket İçi Adet Quantity Per Package	300	Koli İçi Adet Quantity Per Box	300
--	-----	-----------------------------------	-----

PRC 25



İnce Yan Dikme Aparatı
Thin Side Column Equipment Sys.

Paket İçi Adet Quantity Per Package	150	Koli İçi Adet Quantity Per Box	1.500
--	-----	-----------------------------------	-------

PRC 52



Kalın Yan Dikme Aparatı
Thick Side Column Equipment Sys.

Paket İçi Adet Quantity Per Package	100	Koli İçi Adet Quantity Per Box	600
--	-----	-----------------------------------	-----

PRC 77



Geniş Yan Dikme Aparatı
Wide Side Column Equipment Sys.

Paket İçi Adet Quantity Per Package	100	Koli İçi Adet Quantity Per Box	600
--	-----	-----------------------------------	-----

8mm CAM BALKON AKSESUARLARI

8mm Balcony Glass Accessories

PRC 27



Alüminyum Köşe Dönüş Takımı

Hinged T-square

Paket İçi Adet Quantity Per Package	200	Koli İçi Adet Quantity Per Box	200
--	-----	-----------------------------------	-----

PRC 30



Menteşe Takımı Üst

Hinge Up

Paket İçi Adet Quantity Per Package	200	Koli İçi Adet Quantity Per Box	400
--	-----	-----------------------------------	-----

PRC 31



Menteşe Takımı Alt

Hinge Bottom

Paket İçi Adet Quantity Per Package	200	Koli İçi Adet Quantity Per Box	400
--	-----	-----------------------------------	-----

ZZ 126



İspanyolet Kol

Espagnolette Handle

Paket İçi Adet Quantity Per Package	1	Koli İçi Adet Quantity Per Box	40
--	---	-----------------------------------	----

ZZ 068

Antrasit Gri
Anthracite Gray



Akustik Kol

Acoustic Handle

Paket İçi Adet Quantity Per Package	1	Koli İçi Adet Quantity Per Box	50
--	---	-----------------------------------	----

PRC 68

Antrasit Gri
Anthracite Gray



Eksenel Kol

Double Glass Axial Handle

Paket İçi Adet Quantity Per Package	1	Koli İçi Adet Quantity Per Box	10
--	---	-----------------------------------	----





800

Baza Profil
Double Glass Base

Paket İçi Adet Quantity Per Package	6	Gramajı Weight	0,618 kg/m
--	---	-------------------	------------



801

Düz Kapak Profil
Double Glass Flat Cover Profile

Paket İçi Adet Quantity Per Package	6	Gramajı Weight	0,321 kg/m
--	---	-------------------	------------



802

Düz Kapak Mentеше Profil
Double Glass Flat Cover with Hinge Profile

Paket İçi Adet Quantity Per Package	6	Gramajı Weight	0,327 kg/m
--	---	-------------------	------------



803

45° Dönüş Profil
45° Return Profile

Paket İçi Adet Quantity Per Package	6	Gramajı Weight	0,445 kg/m
--	---	-------------------	------------



804

22,5° Dönüş Profil
22,5° Return Profile

Paket İçi Adet Quantity Per Package	6	Gramajı Weight	0,378 kg/m
--	---	-------------------	------------



805

11° Dönüş Profil
11° Return Profile

Paket İçi Adet Quantity Per Package	6	Gramajı Weight	0,366 kg/m
--	---	-------------------	------------

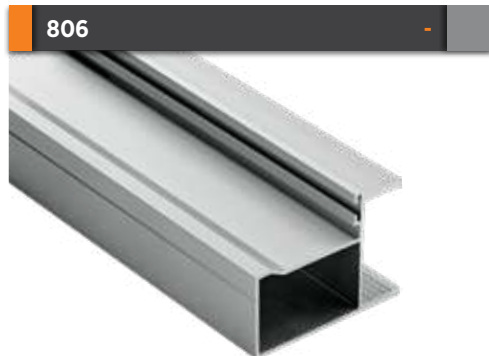

806

90° Dönüş Profil
90° Return Profile

Paket İçi Adet Quantity Per Package	6	Gramajı Weight	0,475 kg/m
--	---	-------------------	------------



807

Açılı Dönüş Mentеше Profil
PopUp Return Hinge Profile

Paket İçi Adet Quantity Per Package	6	Gramajı Weight	0,346 kg/m
--	---	-------------------	------------



808

Isıcam Yan Dikme Profil
Double Glass Side Column Profile

Paket İçi Adet Quantity Per Package	6	Gramajı Weight	0,369 kg/m
--	---	-------------------	------------



809

Sabit Cam Mentеше Profil
Stable Glass Hinge Profile

Paket İçi Adet Quantity Per Package	6	Gramajı Weight	0,328 kg/m
--	---	-------------------	------------



810

Sabit Cam (Tijli) Kilit Profil
Stable Glass Lock Profile

Paket İçi Adet Quantity Per Package	6	Gramajı Weight	0,355 kg/m
--	---	-------------------	------------



811

Sabit Cam (Tijli) Kilit Karşılık Profil
Stable Glass Lock Combination Profile

Paket İçi Adet Quantity Per Package	6	Gramajı Weight	0,342 kg/m
--	---	-------------------	------------

ISICAMLI CAM BALKON PROFİLLERİ

Glazed with Thermopane Glass Balcony Profiles

819



Düz Kasa Üstten Fitilli Profil
Flat Case Top Wicked Profile

Paket İçi Adet Quantity Per Package	3	Gramajı Weight	1,344 kg/m
--	---	-------------------	------------

820



Oluklu Kasa Üstten Fitilli Profil
Corrugated Case Top Wicked Profile

Paket İçi Adet Quantity Per Package	3	Gramajı Weight	1,389 kg/m
--	---	-------------------	------------

822



Açılır Dikme Profil
PopUp Column Profile

Paket İçi Adet Quantity Per Package	6	Gramajı Weight	0,378 kg/m
--	---	-------------------	------------

816



Üstten Fitilli Büyük Oluklu Kasa
Large Corrugated Case with Top Wick

Paket İçi Adet Quantity Per Package	3	Gramajı Weight	1,577 kg/m
--	---	-------------------	------------

817



Üstten Fitilli Büyük Düz Kasa
Large Flat Case with Wed from Top

Paket İçi Adet Quantity Per Package	3	Gramajı Weight	1,532 kg/m
--	---	-------------------	------------

815



Tij Profil
Espagnolette Profile

Paket İçi Adet Quantity Per Package	20	Gramajı Weight	0,100 kg/m
--	----	-------------------	------------

823



Isıcam Geniş Yan Dikme
Double Glass Wide Side Column

Paket İçi Adet Quantity Per Package	6	Gramajı Weight	0,459 kg/m
--	---	-------------------	------------

824



Sabit Cam İspanyolet Profil
Fixed Glass Espagnolette Profile

Paket İçi Adet Quantity Per Package	6	Gramajı Weight	0,583 kg/m
--	---	-------------------	------------

825



Sabit Cam İspanyolet Karşılık Profil
Fixed Glass Espagnolette Handle Provision Profile

Paket İçi Adet Quantity Per Package	6	Gramajı Weight	0,356 kg/m
--	---	-------------------	------------

Alüminyum Renk Seçeneği

Aluminum Color Options

9016

Beyaz
White

E6

Mat Eloksal
Matt Anodized

M0

Mat Bronz
Matt Bronze

PO

Parlak Bronz
Gloss Bronze

8003

Altın Meşe
Golden Oak

8016

Maun
Mahogany

7016

Antrasit Gri
Anthracite Gray

Eloksal Boyalı

Anodized Painted

Bronz Boyalı

Bronze Painted

ZZ 126

Siyah
Black



İspanyollet Kol
Espagnolette Handle

Paket İçi Adet Quantity Per Package	1	Koli İçi Adet Quantity Per Box	40
--	---	-----------------------------------	----

ZZ 068

Antrasit Gri
Anthracite Gray



Akustik Kol
Acoustic Handle

Paket İçi Adet Quantity Per Package	1	Koli İçi Adet Quantity Per Box	50
--	---	-----------------------------------	----

PRC 68

Antrasit Gri
Anthracite Gray



Eksenel Kol
Double Glass Axial Handle

Paket İçi Adet Quantity Per Package	1	Koli İçi Adet Quantity Per Box	10
--	---	-----------------------------------	----

PRC 76



Kilit Karşılık (Metal)
Double Glass Lock Provision (Metal)

Paket İçi Adet Quantity Per Package	100	Koli İçi Adet Quantity Per Box	400
--	-----	-----------------------------------	-----

PRC 63



Bağlantı Adaptörü
Double Glass Connection Adapter

Paket İçi Adet Quantity Per Package	100	Koli İçi Adet Quantity Per Box	1.000
--	-----	-----------------------------------	-------

PRC 65



Destek Takozu
Double Glass Bracket Wedge

Paket İçi Adet Quantity Per Package	200	Koli İçi Adet Quantity Per Box	1.000
--	-----	-----------------------------------	-------

PRC 75



Sistem Tij Pimi
System Rod Pin

Paket İçi Adet Quantity Per Package	100	Koli İçi Adet Quantity Per Box	200
--	-----	-----------------------------------	-----

PRC 73



Isı Cam EPDM Kauçuk Fitol Çift Conta
Double Glass EPDM Rubber Wick Double Gasket

Paket İçi Adet Quantity Per Package	1 Top (10 kg)	Koli İçi Adet Quantity Per Box	≈ 125 m
--	---------------	-----------------------------------	---------

PRC 74



Isı Cam EPDM Kauçuk Fitol Tek Conta
Double Glass EPDM Rubber Wick Single Gasket

Paket İçi Adet Quantity Per Package	1 Top (10 kg)	Koli İçi Adet Quantity Per Box	≈ 290 m
--	---------------	-----------------------------------	---------

830



Fitilli Baza Profil

Wick Base Profile

Paket İçi Adet Quantity Per Package	6	Gramajı Weight	0,680 kg/m
--	---	-------------------	------------

801



Düz Kapak Profil

Flat Cover Profile

Paket İçi Adet Quantity Per Package	6	Gramajı Weight	0,321 kg/m
--	---	-------------------	------------

802



Düz Kapak Mentеше Profil

Flat Cover Hinge Profile

Paket İçi Adet Quantity Per Package	6	Gramajı Weight	0,327 kg/m
--	---	-------------------	------------

803



45° Dönüş Profil

45 degree Turn Profile

Paket İçi Adet Quantity Per Package	6	Gramajı Weight	0,445 kg/m
--	---	-------------------	------------

804



22,5° Dönüş Profil

22,5 degree Turn Profile

Paket İçi Adet Quantity Per Package	6	Gramajı Weight	0,378 kg/m
--	---	-------------------	------------

805



11° Dönüş Profil

11 degree Turn Profile

Paket İçi Adet Quantity Per Package	6	Gramajı Weight	0,366 kg/m
--	---	-------------------	------------

806



90° Dönüş Profil

90 degree Turn Profile

Paket İçi Adet Quantity Per Package	6	Gramajı Weight	0,475 kg/m
--	---	-------------------	------------

807



Açılı Dönüş Mentеше Profil

Angled Turn Hinge Profile

Paket İçi Adet Quantity Per Package	6	Gramajı Weight	0,346 kg/m
--	---	-------------------	------------

808



Isıcam Yan Dikme Profil

Double Glass Side Column Profile

Paket İçi Adet Quantity Per Package	6	Gramajı Weight	0,369 kg/m
--	---	-------------------	------------

809



Sabit Cam Mentеше Profil

Stable Glass Hinge Profile

Paket İçi Adet Quantity Per Package	6	Gramajı Weight	0,328 kg/m
--	---	-------------------	------------

810



Sabit Cam (Tijli) Kilit Profil

Stable Glass Lock Profile

Paket İçi Adet Quantity Per Package	6	Gramajı Weight	0,355 kg/m
--	---	-------------------	------------

811



Sabit Cam (Tijli) Kilit Karşılık Profil

Stable Glass Lock Combination Profile

Paket İçi Adet Quantity Per Package	6	Gramajı Weight	0,342 kg/m
--	---	-------------------	------------



Düz Kasa Profil
Flat Case Profile

Paket İçi Adet Quantity Per Package	3	Gramajı Weight	1,355 kg/m
--	---	-------------------	------------



Oluklu Kasa Profil
Corrugated Case Profile

Paket İçi Adet Quantity Per Package	3	Gramajı Weight	1,396 kg/m
--	---	-------------------	------------



Açılır Dikme Profil
Pop-up Column Profile

Paket İçi Adet Quantity Per Package	6	Gramajı Weight	0,378 kg/m
--	---	-------------------	------------



Oluklu Büyük Kasa Profil
Corrugated Big Case Profile

Paket İçi Adet Quantity Per Package	3	Gramajı Weight	1,611 kg/m
--	---	-------------------	------------



Büyük Düz Kasa Profil
Big Flat Case Profile

Paket İçi Adet Quantity Per Package	3	Gramajı Weight	1,570 kg/m
--	---	-------------------	------------



Tij Profil
Espagnolette Profile

Paket İçi Adet Quantity Per Package	20	Gramajı Weight	0,100 kg/m
--	----	-------------------	------------



Isıcam Geniş Yan Dikme
Double Glass Wide Side Column

Paket İçi Adet Quantity Per Package	6	Gramajı Weight	0,459 kg/m
--	---	-------------------	------------



Sabit Cam İspanyolet Profil
Fixed Glass Espagnolette Profile

Paket İçi Adet Quantity Per Package	6	Gramajı Weight	0,583 kg/m
--	---	-------------------	------------



Sabit Cam İspanyolet Karşılık Profil
Fixed Glass Espagnolette Handle Profile

Paket İçi Adet Quantity Per Package	6	Gramajı Weight	0,356 kg/m
--	---	-------------------	------------

Alüminyum Renk Seçeneği

Aluminum Color Options



9016
Beyaz
White



E6
Mat Eloksal
Matt Anodized



M0
Mat Bronz
Matt Bronze



P0
Parlak Bronz
Gloss Bronze



8003
Altın Meşe
Golden Oak



8016
Maun
Mahogany



7016
Antrasit Gri
Anthracite Gray



Eloksal Boyalı
Anodized Painted



Bronz Boyalı
Bronze Painted

PRC 100

Siyah
Black



Pro+ Düz Profil Kapak - 801
Pro+ Flat Profile Cover - 801

Paket İçi Adet Quantity Per Package	200	Koli İçi Adet Quantity Per Box	1000
--	-----	-----------------------------------	------

PRC 101

Siyah
Black



Pro+ Düz Mentеше Profil Kapak - 802
Pro+ Flat Hinge Profile Cover - 802

Paket İçi Adet Quantity Per Package	200	Koli İçi Adet Quantity Per Box	1000
--	-----	-----------------------------------	------

PRC 102

Siyah
Black



Pro+ 90° Dönüş Profil Kapak Sağ/Sol - 806
Pro+ 90° Turn Profile Cover Right/Left - 806

Paket İçi Adet Quantity Per Package	100	Koli İçi Adet Quantity Per Box	400
--	-----	-----------------------------------	-----

PRC 103

Siyah
Black



Pro+ Sabit Cam İspanyolet Kapak Sağ/Sol - 824
Pro+ Fixed Glass Espagnolette Profile Cover Right/Left - 824

Paket İçi Adet Quantity Per Package	100	Koli İçi Adet Quantity Per Box	400
--	-----	-----------------------------------	-----

PRC 104

Siyah
Black



Pro+ Sabit Cam İspanyolet Karşılık Kapak Sağ/Sol - 825
Pro+ Fixed Glass Espagnolette Handle Cover Right/Left - 825

Paket İçi Adet Quantity Per Package	100	Koli İçi Adet Quantity Per Box	400
--	-----	-----------------------------------	-----

PRC 105

Siyah
Black



Pro+ Açılı Dönüş Profil Kapak Sağ/Sol - 807
Pro+ Angled Turn Hinge Profile Cover Right/Left - 807

Paket İçi Adet Quantity Per Package	100	Koli İçi Adet Quantity Per Box	400
--	-----	-----------------------------------	-----

PRC 106

Siyah
Black



Pro+ Sabit Cam Mentеше Profil Kapak Sağ/Sol - 809
Pro+ Fixed Glass Hinge Profile Cover Right/Left - 809

Paket İçi Adet Quantity Per Package	100	Koli İçi Adet Quantity Per Box	600
--	-----	-----------------------------------	-----

PRC 107

Siyah
Black



Pro+ Alt Teker U Çıkış Kapak
Pro+ Bottom Wheel U Exit Cover

Paket İçi Adet Quantity Per Package	100	Koli İçi Adet Quantity Per Box	800
--	-----	-----------------------------------	-----

PRC 108

Siyah
Black



Pro+ Alt Teker U Çıkış Plastiği
Pro+ Bottom Wheel U Output Plastic

Paket İçi Adet Quantity Per Package	100	Koli İçi Adet Quantity Per Box	400
--	-----	-----------------------------------	-----

PRC 109

Siyah
Black



Pro+ Üst Teker U Çıkış Plastiği
Pro+ Top Wheel U Exit Plastic

Paket İçi Adet Quantity Per Package	100	Koli İçi Adet Quantity Per Box	400
--	-----	-----------------------------------	-----

PRC 110

Siyah
Black



Pro+ Yönlendirici Boynuz
Pro+ Router

Paket İçi Adet Quantity Per Package	100	Koli İçi Adet Quantity Per Box	400
--	-----	-----------------------------------	-----

PRC 65

Siyah
Black



Destek Takozu
Support Wedge

Paket İçi Adet Quantity Per Package	200	Koli İçi Adet Quantity Per Box	1000
--	-----	-----------------------------------	------

PRC 14



Kilitli Metal Teker

Locking Wheel with Stainless Pin (Metal)

Paket İçi Adet Quantity Per Package	250	Koli İçi Adet Quantity Per Box	250
--	-----	-----------------------------------	-----

PRC 13



Düz Metal Teker

Simple Wheel with Stainless Pin (Metal)

Paket İçi Adet Quantity Per Package	250	Koli İçi Adet Quantity Per Box	250
--	-----	-----------------------------------	-----

PRC 75



Sistem Tij Pimi

System Rod Pin

Paket İçi Adet Quantity Per Package	100	Koli İçi Adet Quantity Per Box	200
--	-----	-----------------------------------	-----

PRC 30



Menteşe Takımı Üst

Hinge Up

Paket İçi Adet Quantity Per Package	200	Koli İçi Adet Quantity Per Box	400
--	-----	-----------------------------------	-----

PRC 31



Menteşe Takımı Alt

Hinge Bottom

Paket İçi Adet Quantity Per Package	200	Koli İçi Adet Quantity Per Box	400
--	-----	-----------------------------------	-----

PRC 76



Kilit Karşılık (Metal)

Double Glass Lock Apparatus (Metal)

Paket İçi Adet Quantity Per Package	100	Koli İçi Adet Quantity Per Box	400
--	-----	-----------------------------------	-----

PRC 22



Polyemit Lama 4'lü

Guide and Brake for System (4)

Paket İçi Adet Quantity Per Package	200	Koli İçi Adet Quantity Per Box	200
--	-----	-----------------------------------	-----

PRC 23



Polyemit Lama 7'li

Guide and Brake for System (7)

Paket İçi Adet Quantity Per Package	200	Koli İçi Adet Quantity Per Box	200
--	-----	-----------------------------------	-----

PRC 24



Polyemit Lama 10'lü

Guide and Brake for System (10)

Paket İçi Adet Quantity Per Package	100	Koli İçi Adet Quantity Per Box	100
--	-----	-----------------------------------	-----

PRC 25



İnce Yan Dikme Aparatı

Thin Side Column Equipment Sys.

Paket İçi Adet Quantity Per Package	150	Koli İçi Adet Quantity Per Box	1.500
--	-----	-----------------------------------	-------

PRC 52



Kalın Yan Dikme Aparatı

Thick Side Column Equipment Sys.

Paket İçi Adet Quantity Per Package	100	Koli İçi Adet Quantity Per Box	600
--	-----	-----------------------------------	-----

PRC 77



Geniş Yan Dikme Aparatı

Wide Side Column Equipment Sys.

Paket İçi Adet Quantity Per Package	100	Koli İçi Adet Quantity Per Box	600
--	-----	-----------------------------------	-----

Pro+ ISICAMLI CAM BALKON AKSESUARLARI

Pro+ Glazed with Thermopane Glass Balcony Accessories

ZZ 126

Siyah
Black



İspanyolet Kol
Espagnolette Handle

Paket İçi Adet Quantity Per Package	1	Koli İçi Adet Quantity Per Box	40
--	---	-----------------------------------	----

ZZ 068

Antrasit Gri
Anthracite Gray



Akustik Kol
Acoustic Handle

Paket İçi Adet Quantity Per Package	1	Koli İçi Adet Quantity Per Box	50
--	---	-----------------------------------	----

PRC 68

Antrasit Gri
Anthracite Gray



Eksenel Kol
Double Glass Axial Handle

Paket İçi Adet Quantity Per Package	1	Koli İçi Adet Quantity Per Box	10
--	---	-----------------------------------	----

PRC 73



Isı Cam EPDM Kauçuk Fitol Çift Conta
Double Glass EPDM Rubber Wick Double Gasket

Paket İçi Adet Quantity Per Package	1 Top (10 kg)	Koli İçi Adet Quantity Per Box	125 m
--	---------------	-----------------------------------	-------

PRC 74



Isı Cam EPDM Kauçuk Fitol Tek Conta
Double Glass EPDM Rubber Wick Single Gasket

Paket İçi Adet Quantity Per Package	1 Top (10 kg)	Koli İçi Adet Quantity Per Box	290 m
--	---------------	-----------------------------------	-------

PRC 21



Polyemit Lama Tekli
Guide and Brake for System

Paket İçi Adet Quantity Per Package	300	Koli İçi Adet Quantity Per Box	300
--	-----	-----------------------------------	-----

PRC 26



Borulu Stoplama
Stopper

Paket İçi Adet Quantity Per Package	150	Koli İçi Adet Quantity Per Box	150
--	-----	-----------------------------------	-----



210



Sürme Baza Profil
Sliding Base Profile

Paket İçi Adet Quantity Per Package	5	Gramajı Weight	0,643 kg/m
--	---	-------------------	------------

215



Çekme Kol Profil
Pull Handle Profile

Paket İçi Adet Quantity Per Package	3	Gramajı Weight	0,908 kg/m
--	---	-------------------	------------

212



Kenet Profil
Clamp Profile

Paket İçi Adet Quantity Per Package	6	Gramajı Weight	0,423 kg/m
--	---	-------------------	------------

211



Birleştirme Karşılık Profil
Combination Provisions Profile

Paket İçi Adet Quantity Per Package	6	Gramajı Weight	0,301 kg/m
--	---	-------------------	------------

213



İkili Eşikli Alt Kasa Profil
Double Threshold Lower Case Profile

Paket İçi Adet Quantity Per Package	4	Gramajı Weight	0,974 kg/m
--	---	-------------------	------------

222



Üçlü Eşikli Alt Kasa Profil
Triple Threshold Lower Case Profile

Paket İçi Adet Quantity Per Package	2	Gramajı Weight	1,333 kg/m
--	---	-------------------	------------

220



Üçlü Eşiksiz Alt Kasa Profil
Triple Bottom Case Profile without Threshold

Paket İçi Adet Quantity Per Package	4	Gramajı Weight	0,867 kg/m
--	---	-------------------	------------

229



İkili Üst Kasa Profil
Double Upper Case Profile

Paket İçi Adet Quantity Per Package	2	Gramajı Weight	1,120 kg/m
--	---	-------------------	------------

230



Üçlü Üst Kasa Profil
Triple Upper Case Profile

Paket İçi Adet Quantity Per Package	2	Gramajı Weight	1,552 kg/m
--	---	-------------------	------------

221



Dörtlü Eşiksiz Alt Kasa Profil
Quadruple Bottom Case Profile without Threshold

Paket İçi Adet Quantity Per Package	2	Gramajı Weight	1,156 kg/m
--	---	-------------------	------------

214



İkili Yan Kasa Profil
Double Side Case Profile

Paket İçi Adet Quantity Per Package	4	Gramajı Weight	0,587 kg/m
--	---	-------------------	------------

223



Üçlü Yan Kasa Profil
Triple Side Case Profile

Paket İçi Adet Quantity Per Package	2	Gramajı Weight	0,792 kg/m
--	---	-------------------	------------



8 mm Cam Adaptörü
8 mm Glass Adapter

Paket İçi Adet Quantity Per Package	10	Gramajı Weight	0,219 kg/m
--	----	-------------------	------------



Kapatma Profil
Closing Profile

Paket İçi Adet Quantity Per Package	20	Gramajı Weight	0,071 kg/m
--	----	-------------------	------------



İspanyolet Çekme Kol Profili
Espagnolette Pull Handle Profile

Paket İçi Adet Quantity Per Package	3	Gramajı Weight	0,751 kg/m
--	---	-------------------	------------

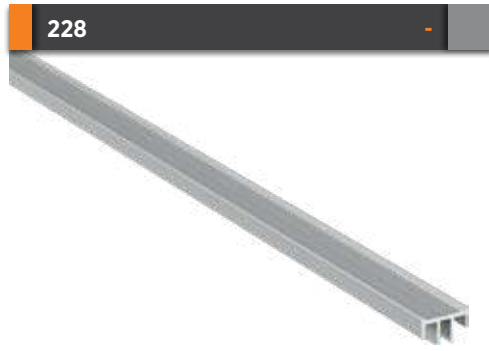

İspanyolet Karşılık Profili
Espagnolette Provision Profile

Paket İçi Adet Quantity Per Package	10	Gramajı Weight	0,156 kg/m
--	----	-------------------	------------

Alüminyum Renk Seçeneği

Aluminum Color Options



Beyaz
White



Mat Eloksal
Matt Anodized



Mat Bronz
Matt Bronze



Parlak Bronz
Gloss Bronze



Altın Meşe
Golden Oak



Maun
Mahogany



Antrasit Gri
Anthracite Gray



Eloksal Boyalı
Anodized Painted



Bronz Boyalı
Bronze Painted

PSS 1

Siyah
Black



Çekme Kol Profil Aksesuarı
Sliding Profile Plastic

Paket İçi Adet Quantity Per Package	50	Koli İçi Adet Quantity Per Box	200
--	----	-----------------------------------	-----

PSS 2

Siyah
Black



Kenet Profil Aksesuarı - Üst
Tensile Profile Plastic Top

Paket İçi Adet Quantity Per Package	50	Koli İçi Adet Quantity Per Box	200
--	----	-----------------------------------	-----

PSS 3

Siyah
Black



Kenet Profil Aksesuarı - Alt
Tensile Profile Plastic Bottom

Paket İçi Adet Quantity Per Package	50	Koli İçi Adet Quantity Per Box	200
--	----	-----------------------------------	-----

PSS 4

Siyah
Black



İspanyollet Çekme Kol Aksesuarı
Espagnolette Pull Handle Accessory

Paket İçi Adet Quantity Per Package	50	Koli İçi Adet Quantity Per Box	200
--	----	-----------------------------------	-----

PSS 5

Siyah
Black



İkili Köşe Takoğu
Double Corner Wedge

Paket İçi Adet Quantity Per Package	50	Koli İçi Adet Quantity Per Box	200
--	----	-----------------------------------	-----

PSS 6

Siyah
Black



Üçlü Köşe Takoğu
Triple Corner Wedge

Paket İçi Adet Quantity Per Package	50	Koli İçi Adet Quantity Per Box	200
--	----	-----------------------------------	-----

PSS 7

Siyah
Black



Vida Tapası
Screw Plug

Koli İçi Adet Quantity Per Box	2.000
-----------------------------------	-------

PSS 12

Siyah
Black



Sürme Yalıtım Aksesuarı
Sliding Insulation Accessory

Koli İçi Adet Quantity Per Box	200
-----------------------------------	-----

PSS 8



Paslanmaz Lüks Teker
Stainless Luxury Wheel

Koli İçi Adet Quantity Per Box	200
-----------------------------------	-----

PSS 9



Havuz Kol (Kilitsiz)
Hole Handle (Unlocked)

Paket İçi Adet Quantity Per Package	1	Koli İçi Adet Quantity Per Box	1
--	---	-----------------------------------	---

PSS 10



Klips Kol
Clasp Handle

Paket İçi Adet Quantity Per Package	1	Koli İçi Adet Quantity Per Box	1
--	---	-----------------------------------	---

PSS 11



Kale 201 F (Horoz) Kilit
Kale 201 F (Pin) Lock

Paket İçi Adet Quantity Per Package	1	Koli İçi Adet Quantity Per Box	1
--	---	-----------------------------------	---



140

Sabit Panel Açılır Alt Baza Profil
Fixed Panel Pop-up Base Profile

Paket İçi Adet Quantity Per Package	6	Gramajı Weight	0,563 kg/m
--	---	-------------------	------------



164

Sabit Panel Yan Dikme Profil
Fixed Panel Side Column Profile

Paket İçi Adet Quantity Per Package	4	Gramajı Weight	0,842 kg/m
--	---	-------------------	------------



142

Sabit Panel Üst Baza Profil
Fixed Panel Top Base Profile

Paket İçi Adet Quantity Per Package	4	Gramajı Weight	0,750 kg/m
--	---	-------------------	------------



167

Kenet Baza Profil
Clamp Base Profile

Paket İçi Adet Quantity Per Package	4	Gramajı Weight	1,144 kg/m
--	---	-------------------	------------



144

Hareketli Panel Yan Dikme Profil
Movable Panel Side Column Profile

Paket İçi Adet Quantity Per Package	6	Gramajı Weight	0,434 kg/m
--	---	-------------------	------------



145

Kúpeşte Baza Profil
Handrail Base Profile

Paket İçi Adet Quantity Per Package	6	Gramajı Weight	0,579 kg/m
--	---	-------------------	------------



146

Hareketli Panel Açılır Alt Baza Profil
Movable Panel Pop-up Lower Base Profile

Paket İçi Adet Quantity Per Package	4	Gramajı Weight	0,741 kg/m
--	---	-------------------	------------



161

Ray Kapatma "T" Profil
Rail Closure "T" Profile

Paket İçi Adet Quantity Per Package	4	Gramajı Weight	0,482 kg/m
--	---	-------------------	------------



160

Yan Ray "T" Profil
Side Rail "T" Profile

Paket İçi Adet Quantity Per Package	2	Gramajı Weight	1,057 kg/m
--	---	-------------------	------------



166

Açılımlı için Ray Kapatma 'L' Profil
Rail Closure 'L' Profile for Opening

Paket İçi Adet Quantity Per Package	10	Gramajı Weight	0,144 kg/m
--	----	-------------------	------------



162

Yan Ray "L" Profil
Side Rail "L" Profile

Paket İçi Adet Quantity Per Package	4	Gramajı Weight	0,703 kg/m
--	---	-------------------	------------



GYT 28

Et Kalınlığı 1,2 mm
wall thickness 1,2 mm

Sac Tambur Borusu
Sheet Drum Pipe

Paket İçi Adet Quantity Per Package	1	Boy Length	7 m
--	---	---------------	-----



152

Alt Kasa Profil
Lower Case Profile

Paket İçi Adet Quantity Per Package	2	Gramajı Weight	1,563 kg/m
--	---	-------------------	------------



156

Üst Kasa Profil
Top Case Profile

Paket İçi Adet Quantity Per Package	1	Gramajı Weight	3,449 kg/m
--	---	-------------------	------------



153

Üst Kasa Kapak Profil
Top Case Cover Profile

Paket İçi Adet Quantity Per Package	2	Gramajı Weight	0,864 kg/m
--	---	-------------------	------------



155

Yan Kasa Profil
Side Case Profile

Paket İçi Adet Quantity Per Package	2	Gramajı Weight	1,669 kg/m
--	---	-------------------	------------



154

Küpeşte Profil
Handrail Profile

Paket İçi Adet Quantity Per Package	2	Gramajı Weight	0,759 kg/m
--	---	-------------------	------------



165

Yan Kasa Kertme Profil
Side Case Notched Profile

Paket İçi Adet Quantity Per Package	4	Gramajı Weight	0,644 kg/m
--	---	-------------------	------------



158

Açılımsız Tek Fital Yan Ray L Kasa Profil
Single Weatherstrips Without Opening Side L Case Profile

Paket İçi Adet Quantity Per Package	4	Gramajı Weight	0,510 kg/m
--	---	-------------------	------------



159

Açılımsız Çift Fital Yan Ray L Kasa Profil
Double Weatherstrips Without Opening Side L Case Profile

Paket İçi Adet Quantity Per Package	4	Gramajı Weight	0,660 kg/m
--	---	-------------------	------------



219

Tek Cam Adaptörü/ Single Glass Adapter

8 mm Cam Adaptörü
8mm Glass Adapter

Paket İçi Adet Quantity Per Package	10	Gramajı Weight	0,219 kg/m
--	----	-------------------	------------



149

Açılımsız İçin Ray Kapatma 'L' Profil
Rail Closure 'L' Profile for Non-Opening

Paket İçi Adet Quantity Per Package	10	Gramajı Weight	0,162 kg/m
--	----	-------------------	------------

Alüminyum Renk Seçeneği

Aluminum Color Options



9016
Beyaz
White



E6
Mat Eloksal
Matt Anodized



MO
Mat Bronz
Matt Bronze



8003
Altın Meşe
Golden Oak



8016
Maun
Mahogany



7016
Antrasit Gri
Anthracite Gray



9005
Siyah
Black

GYT 1

Siyah
Black



Küpeste Baza Profil Aksesuarı
Handrail Base Profile Accessories

Koli İçi Adet
Quantity Per Box 100

GYT 2

Siyah
Black



Sabit Panel Aksesuar - Alt
Fixed Panel Accessory - Bottom

Koli İçi Adet
Quantity Per Box 100

GYT 3 A

Siyah
Black



Kenet Kapak Profil - Sağ / Sol - 146
Clamp Profile Plastics - Right / Left - 146

Koli İçi Adet
Quantity Per Box 200

GYT 3 B

Siyah
Black



Kenet Kapak Profil - Sağ / Sol - 167
Clamp Profile Plastics - Right / Left - 167

Koli İçi Adet
Quantity Per Box 400

GYT 4



Oluklu Köşe Takozu
Corrugated Corner Wedge

Koli İçi Adet
Quantity Per Box 50

GYT 5



Köşe Takozu
Corner Wedge

Koli İçi Adet
Quantity Per Box 100

GYT 6

Siyah
Black



Üst Kasa Rulmanlı Kapak
Top Case Bearing Cover

Koli İçi Adet
Quantity Per Box 20

GYT 7

Siyah
Black



Üst Kasa Motor Bağlantı Kapak
Top Case Engine Connection Cover

Koli İçi Adet
Quantity Per Box 20

GYT 8

Siyah
Black



Yan Kasa Köşe Birleştirme Takozu
Side Case Corner Joint Plastic

Koli İçi Adet
Quantity Per Box 100

GYT 9

Siyah
Black



Küpeste Kapağı - Sağ / Sol
Handrail Cover - Right / Left

Koli İçi Adet
Quantity Per Box 200

GYT 10

Siyah
Black



Zincir Kapama Aksesuar Sağ/Sol
Chain Cover Accessory - Right / Left

Koli İçi Adet
Quantity Per Box 200

GYT 11

Siyah
Black



Çift Açılır Sabit Panel Aksesuar Üst - Sağ/Sol
Double Open Fixed Panel Accessory Top - Right/Left

Koli İçi Adet
Quantity Per Box 200

GYT 27

Siyah
Black



Açılımsız Sabit Panel Aksesuar - Alt
Fixed Panel Accessory without Opening - Bottom

Koli İçi Adet
Quantity Per Box

100

GYT 12



Özel Cephe Makası
Special Facade Scissors

Koli İçi Adet
Quantity Per Box

6 Set/Sets

GYT 13

Siyah
Black



Orta Panel Çeliği
Center Panel Steel

Koli İçi Adet
Quantity Per Box

40

GYT 14

Siyah
Black



Kilit Takımı
Lock Set

Koli İçi Adet
Quantity Per Box

100

GYT 15

Siyah
Black



Zincir Bağlantı Elemanı
Chain Connector

Koli İçi Adet
Quantity Per Box

40

GYT 16



Tekerli Bağlantı Elemanı
Wheel Connector

Koli İçi Adet
Quantity Per Box

80

GYT 17

Siyah
Black



Panel Hizalama - Sağ/Sol
Panel Aligning - Right/Left

Koli İçi Adet
Quantity Per Box

100

GYT 19



Tambur Bağlantı Elemanı
Drum Connector

Koli İçi Adet
Quantity Per Box

20

GYT 20



Zincir Dişli
Sprocket

Koli İçi Adet
Quantity Per Box

20

GYT 18

Siyah
Black



Zincir Yönlendirici
Chain Router

Koli İçi Adet
Quantity Per Box

100

GYT 21



Zincir
Chain

Koli İçi Adet
Quantity Per Box

1 (5 m)

GYT 25



Zincir Ağırlık
Chain Weight

Koli İçi Adet
Quantity Per Box

16



Sabit Panel Sızdırmazlık Contası
Fixed Panel Sealing Gasket

Koli İçi Adet
Quantity Per Box 200 m



Üst Kasa Balon Conta
Top Case Balloon Gasket

Koli İçi Adet
Quantity Per Box 100 m



Sabit Panel Yaprak Conta
Fixed Panel Leaf Gasket

Koli İçi Adet
Quantity Per Box 100 m



Giyotin Motor (120Nm)
Guillotine Engine (120Nm)

Koli İçi Adet
Quantity Per Box 1



Motor Kumandası (tekli)
Engine Remote Control (mono)

Koli İçi Adet
Quantity Per Box 1



Motor Kumandası (çoklu)
Engine Remote Control (multi)

Koli İçi Adet
Quantity Per Box 1



Giyotin Motor (120Nm)
Guillotine Engine (120Nm)

Koli İçi Adet
Quantity Per Box 1



Motor Kumandası (tekli)
Engine Remote Control (mono)

Koli İçi Adet
Quantity Per Box 1



Motor Kumandası (çoklu)
Engine Remote Control (multi)

Koli İçi Adet
Quantity Per Box 1



417



Sonlandırıcı Cam Çıta Kapak Profili
End Cap Glass Strip Cover Profile

Paket İçi Adet Quantity Per Package	4	Gramajı Weight	0,467 kg/m
--	---	-------------------	------------

418



Cam Çıta Kapak Profili
Glass Strip Cover Profile

Paket İçi Adet Quantity Per Package	10	Gramajı Weight	0,329 kg/m
--	----	-------------------	------------

419



Orta Kayıt Profili
Center Mullion Profile

Paket İçi Adet Quantity Per Package	2	Gramajı Weight	2,100 kg/m
--	---	-------------------	------------

420

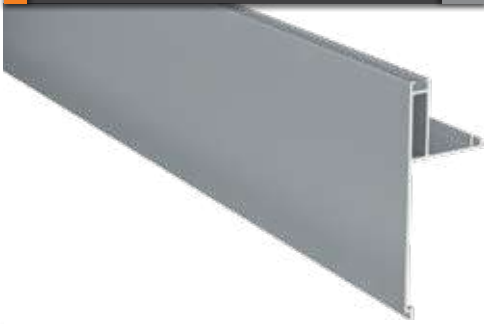

Kasa Kapatma Profili
Frame Closure Profile

Paket İçi Adet Quantity Per Package	2	Gramajı Weight	0,682 kg/m
--	---	-------------------	------------

421

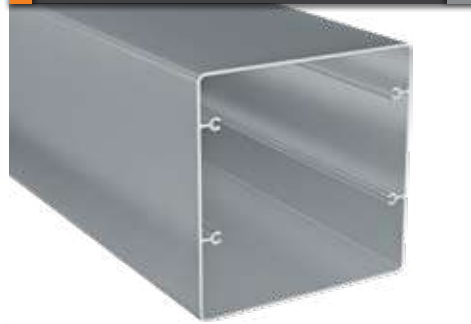

Ayak Profili
Leg Profile

Paket İçi Adet Quantity Per Package	1	Gramajı Weight	3,184 kg/m
--	---	-------------------	------------

422



Oluk Profili
Groove Profile

Paket İçi Adet Quantity Per Package	1	Gramajı Weight	4,318 kg/m
--	---	-------------------	------------

423



Destekli Orta Kayıt Profili
Reinforced Center Mullion Profile

Paket İçi Adet Quantity Per Package	2	Gramajı Weight	3,142 kg/m
--	---	-------------------	------------

424



Duvar Kasa Profili
Wall Frame Profile

Paket İçi Adet Quantity Per Package	1	Gramajı Weight	2,835 kg/m
--	---	-------------------	------------

426



Gizli Ayak Profili
Hidden Leg Profile

Paket İçi Adet Quantity Per Package	1	Gramajı Weight	3,434 kg/m
--	---	-------------------	------------

427



Destek Kutu Profili
Reinforcing Box Profile

Paket İçi Adet Quantity Per Package	2	Gramajı Weight	2,271 kg/m
--	---	-------------------	------------

428

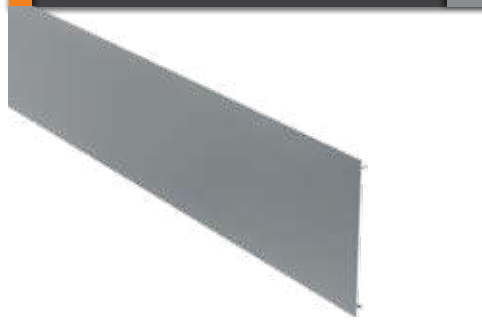

Gizli Ayak ve Destek Kutu Kapatma Profili
Hidden Leg Case Cover Support Profile

Paket İçi Adet Quantity Per Package	10	Gramajı Weight	0,501 kg/m
--	----	-------------------	------------

429



Cam Çıtası Profili
Glass Strip Profile

Paket İçi Adet Quantity Per Package	2	Gramajı Weight	0,578 kg/m
--	---	-------------------	------------

CAM TAVAN PROFİLLERİ

Glass Ceiling Profiles

430



Ledli Orta Kayıt Profili
Center Mullion Profile with Led

Paket İçi Adet Quantity Per Package	2	Gramajı Weight	2,252 kg/m
--	---	-------------------	------------

431

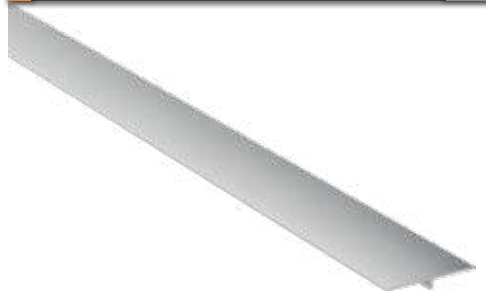

T Profili
T Profile

Paket İçi Adet Quantity Per Package	10	Gramajı Weight	0,079 kg/m
--	----	-------------------	------------

CAM TAVAN AKSESUARLARI

Glass Ceiling Accessories

⊕ İşaretili ürünler proje profil renklerine göre sipariş edilebilir.
⊕ Marked products can be ordered according to project-specific profile colors.

CT 01

Siyah
Black



Orta Kayıt Plastik Kapak
Middle Mullion Plastic Cover

Koli İçi Adet Quantity Per Box	60
-----------------------------------	----

CT 02

⊕ Renk seçenekleri mevcuttur
⊕ Color options are available



Ayak Profili Sabitleme Aksesuarı
Leg Profile Fixing Accessory

Koli İçi Adet Quantity Per Box	20
-----------------------------------	----

CT 03

⊕ Renk seçenekleri mevcuttur
⊕ Color options are available



Metal Oluk Kasa Kapak - Sağ/Sol
Metal Gutter Box Cover - Right/Left

Koli İçi Adet Quantity Per Box	20
-----------------------------------	----

CT 04

⊕ Renk seçenekleri mevcuttur
⊕ Color options are available



Metal Duvar Kasa Kapak - Sağ/Sol
Metal Wall Casing Cover - Right/Left

Koli İçi Adet Quantity Per Box	20
-----------------------------------	----

CT 05



Oluklu Kasa Bağlantı Aksesuarı
Corrugated Box Connection Accessory

Koli İçi Adet Quantity Per Box	100
-----------------------------------	-----

CT 06



Duvar Kasa Bağlantı Aksesuarı
Wall Casing Connection Accessory

Koli İçi Adet Quantity Per Box	100
-----------------------------------	-----



Orta Kayıt Contası
Middle Mullion Gasket

Koli İçi Adet
Amount within parcel 200 mt



Cam Çıta Contası
Glass Strip Gasket

Koli İçi Adet
Amount within parcel 140 mt



Oluk Kasa Yalıtım Yaprak Contası
Gutter Box Insulation Leaf Gasket

Koli İçi Adet
Quantity Per Box 85 mt



Duvar Kasa Yalıtım Yaprak Contası
Wall Casing Insulation Leaf Gasket

Koli İçi Adet
Quantity Per Box 55 mt



Gizli Ayak Profili Sabitleme Aksesuarı
Hidden Leg Profile Fixing Accessory

Koli İçi Adet
Quantity Per Box 20



Destek Kutu Sabitleme Aksesuarı
Reinforcing Box Fixing Accessory

Koli İçi Adet
Quantity Per Box 40



Filtre Kapağı
Filter Cover

Koli İçi Adet
Quantity Per Box 20



Contalı Pul
Gasket Flake

Koli İçi Adet
Quantity Per Box 200



Plastik Led Kapak Profil
Plastic Led Cover Profile

Koli İçi Adet
Quantity Per Box 6 m

Plise Perde

Perdecilik sektörünün teknolojik gelişmelere paralel olarak sürekli bir ilerleme göstermesinin sonucunda tüm mekanlarda kullanılabilecek yeni nesil perde sistemleri geliştirerek müşterilerimizin konforunu sağlamayı hedefliyoruz. Klasik perde kumaşlarından farklı olarak güneş ışınlarını filtrelemek, mekanlarda ısı dengesini sağlamak gibi işlevleri olan teknik kumaşlardan yapılan modern perde modellerinin kullanımı giderek daha yaygın hale geliyor. İple kontrol edilenlerinin yanında motorlu alternatifleri de olan plise perde modelleri özellikle modern tarzda dekore edilmiş mekanlara çok iyi uyum sağlıyor.

Özellikleri

Plise perde sistemlerinin katlanır cam balkonlar, geometrik pencereler PVC pencere ve kapılar için çözüm odaklı olduğunu söylesek yanlış olmayız. Aynı zaman da sürekli olarak ulaşılması zor noktalar için de başarılı çözümler geliştirmiştir. Yarı geçirgen yapısı sayesinde aydınlık ortamlar yaratır.

Katlanır cam balkon sistemlerinde, PVC pencere ve kapılarda, Winter Garden (Kış Bahçesi) Sistemlerde, yat, tekne, tavan perdeleri, çatı perdesi, eğimli ve geometrik pencereler vs. uygulamalarda kullanılmaktadır. Motorlu ve kumandalı sistemlerinde çok rahatlıkla uygulandığı modeller arasındadır.

Yıkılabilen, silinebilen özelliği ile plise perde sistemleri kolay kullanım sağlar. Aynı zaman da alev almama özelliği ile de sağlıklı ortamlar yaratır.

Pleat Curtain

In parallel with the technological developments of the curtain-making industry, We aim to improve the comfort of our customers by developing new-generation curtain systems and to provide the best possible service. Unlike classic curtain fabrics, modern curtain models made of technical fabrics have functions such as filtering sunlight and providing heat balance in spaces, becoming more widespread. Especially in areas decorated in a modern style, motorized pleated blinds are a good alternative to rope-controlled pleated blinds.

Properties

Pleated curtain systems are a beautiful solution for folding glass balconies, geometric windows, PVC windows, and doors. It has also developed successful solutions that can be used for hard-to-reach spots. Thanks to its semi-permeable structure creates bright environments.

Folding glass balcony systems, PVC windows, and doors, Winter Garden (Winter Garden) Systems, yacht, boat, ceiling curtains, roof curtains, curved and geometric windows, etc. applications are being used.

Pleat curtain systems with washable and wipeable features provides easy use. At the same time, with its non-flammable feature creates healthy and safe environments.



Plise Perde Nedir?

Katlanır cam balkon sistemleri ve PVC Kapı, pencereler için sıklıkla tercih edilen, ipli mekanizmasıyla aşağı-yukarı yönlü hareket imkanı sağlayan, mekanda gün ışığının yumuşak bir şekilde dağılımını sağlayan bir perde türüdür. Özellikle çatı katları, gemiler, kış bahçeleri, katlanır cam balkon sistemleri gibi mekanların çok köşeli, eğimli, bazen ulaşılması zor olan pencereleri için kullanılmaya uygundur. Görünümü dekoratif, kullanımı pratiktir. Belli bir boyuta kadar tek parça olarak uygulanabildiği gibi ayrı cam kanatlara uygun ebattaki parçalar halinde monte edilerek uygulanabilmektedir.



Mekanlarda Sade ve Modern Bir Görünüm

Plise perdelerin görünümü sade ve detaysızdır, bu yüzden hemen her ortama uyum sağlarlar. Biraz modern - biraz klasik veya daha gösterişli bir görünüm istediğiniz mekanlar için plise perdeyi kumaş perdelerle kombinleyerek de kullanabilirsiniz.

A Simple and Modern Appearance in Spaces

The appearance of pleated curtains is plain and without details, so immediately they adapt to any environment. A little modern - a little classic or more Pleat curtain for places where you want a flashy look. You can also use it in combination with fabric curtains.



İple Kontrol Etmek Tek Seçenek Değil

Plise perdenizi mekanizmasındaki ip sistemi yardımıyla kontrol edebilir veya motorlu olarak üretilmesini tercih edebilirsiniz.

Rope Control Is Not The Only Option

You can use your pleated curtain with the help of the rope system or you can choose to have a motorized system.

Modern bir dizaynı olan bu fonksiyonel perde türü tasarım ilkelerinin bir avantajı olarak mekanlarda enerji sarfiyatının azaltılmasına yardımcı olur. Güçlü ve kullanışlı bir perde türüdür. Katlanmış hali çok az yer kapladığı için görüntü kirliliğine yol açmaz. 3 metre uzunluğundaki bir tepe penceresine uygulanması durumunda, toplandığında kapladığı yer 10 cm civarındadır. Farklı renk seçenekleri mevcuttur. Esnek yapısı sayesinde dar bölgelerde, asimetrik formlu, üçgen veya dairesel pencerelerde, tavanlarda kullanılabilir. Pencere kanatlarıyla tavan arasındaki mesafenin az olması durumunda da uygulanabilir. Mekanları sıcak günlerde fazla ısınmaktan korur, istenilen ölçüde mahremiyet sağlar. Tavan camları veya cam balkon için perdeye ihtiyacınız varsa plise perde sizin için en iyi seçim olacaktır.

What is Pleat Curtain?

It is a type of curtain that is frequently preferred in folding glass balcony systems and PVC doors and windows and provides soft light to spaces with its up-down movement with a rope mechanism. It is suitable for use on windows which have very angular, curved, that are difficult to reach especially such as spaces folding glass balcony systems in attics, ships, winter gardens. It has a decorative appearance and is practical to use. It can be applied in one piece up to a certain size or in pieces of suitable size for separate glass wings. It is a functional curtain type with a modern design, consisting of a combination of design principles. It has an advantage that helps reduce energy consumption in spaces.

It is a strong and useful type of curtain. It takes very little space when folded therefore does not cause visual pollution. If a 3-meter long curtain applied to the skylight, when its folded the space occupied around 10 cm. Different color options are available. Thanks to its flexible structure, it can be applied to asymmetric, triangular or circular shape windows at ceilings or narrow areas. It can also be applied if the distance between ceiling with window sashes is small. It protects spaces from overheating on hot days, and provides required privacy. If you need curtains for ceiling glazing or a glass balcony, pleated curtain will be the best choice for you.



T Profil Kapak
T Profile Cover

Paket İçi Adet Quantity Per Package	1.000	Koli İçi Adet Quantity Per Box	2.000
--	-------	-----------------------------------	-------



Small T Profil Kapak
Small T Profile Cover

Paket İçi Adet Quantity Per Package	1.000	Koli İçi Adet Quantity Per Box	2.000
--	-------	-----------------------------------	-------



Çiftli Orta Profil Kapak
Double Middle Profile Cover

Paket İçi Adet Quantity Per Package	500	Koli İçi Adet Quantity Per Box	500
--	-----	-----------------------------------	-----



20'lik T Profil Kapak
20 T Profile Cover

Paket İçi Adet Quantity Per Package	500	Koli İçi Adet Quantity Per Box	1.000
--	-----	-----------------------------------	-------



Yaylı Yapışkan Profil Kapak
Spring Adhesive Profile Cover

Paket İçi Adet Quantity Per Package	500	Koli İçi Adet Quantity Per Box	1.000
--	-----	-----------------------------------	-------



Yaylı Portray Profil Kapak
Spring Portray Profile Cover

Paket İçi Adet Quantity Per Package	1.000	Koli İçi Adet Quantity Per Box	1.000
--	-------	-----------------------------------	-------



Kilit Takımı (Çıtçıklı)
Lock Set (with snap fastener)

Paket İçi Adet Quantity Per Package	1.000	Koli İçi Adet Quantity Per Box	2.000
--	-------	-----------------------------------	-------

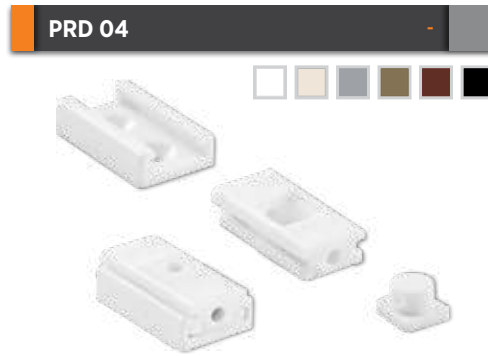

Kilit Takımı (Alyanlı)
Lock Set (with hex key)

Paket İçi Adet Quantity Per Package	1.000	Koli İçi Adet Quantity Per Box	2.000
--	-------	-----------------------------------	-------

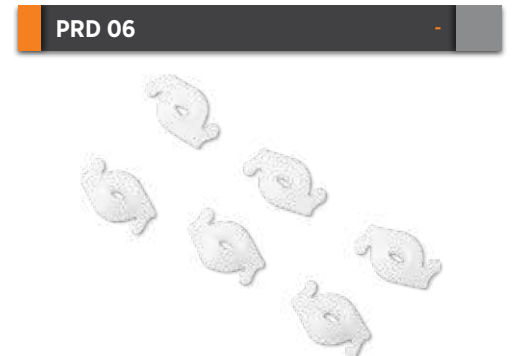

Çiftli Orta Profil Klips
Double Middle Profile Clip

Paket İçi Adet Quantity Per Package	500	Koli İçi Adet Quantity Per Box	1.000
--	-----	-----------------------------------	-------



Yaylı Portray Klips
Spring Portray Cleps

Koli İçi Adet Quantity Per Box	1.000
-----------------------------------	-------



Kuş Gözü (Metal) 4 mm **Kuş Gözü (Metal) 3 mm**
Rivet (Metal) 4 mm Rivet (Metal) 3 mm

Paket İçi Adet Quantity Per Package	5.000	Koli İçi Adet Quantity Per Box	5.000
--	-------	-----------------------------------	-------



Kuş Gözü (Plastik)
Rivet (Plastic)

Paket İçi Adet Quantity Per Package	5.000	Koli İçi Adet Quantity Per Box	10.000
--	-------	-----------------------------------	--------

PRD 47



Çiftli Orta Profil Klips Anahtarı (Metal)
Double Middle Profile Clip Key (Metal)

Paket İçi Adet Quantity Per Package	1	Koli İçi Adet Quantity Per Box	1
--	---	-----------------------------------	---

PRD 35



Perde Çekme Aparatı
Curtain Pulling Apparatus

Paket İçi Adet Quantity Per Package	1	Koli İçi Adet Quantity Per Box	1
--	---	-----------------------------------	---

PRD 34



Montaj Vidası (2,9x6,5 YHB)
Mounting Screw (2.9x6.5 YHB)

Koli İçi Adet Quantity Per Box	10.000
-----------------------------------	--------

PRD 07



12 mm Bantlı Şerit
12 mm Taped Strip

Paket İçi Adet Quantity Per Package	50	Koli İçi Adet Quantity Per Box	500
--	----	-----------------------------------	-----

PRD 39



Çift Taraflı Silikonlu Bant
Double Sided Silicone Tape

Paket İçi Adet Quantity Per Package	1	Koli İçi Adet Quantity Per Box	35 m
--	---	-----------------------------------	------

PRD 05



Plise Perde İp
Pleat Curtain Rope

Paket İçi Adet Quantity Per Package	1 rulo/ roll	Koli İçi Adet Quantity Per Box	12
--	--------------	-----------------------------------	----

PRD 34

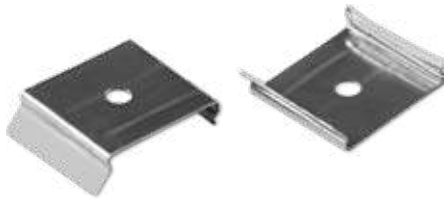

Portray Profil Metal Klips
Portray Profile Metal Clip

Paket İçi Adet Amount within package	500	Koli İçi Adet Amount within parcel	1.000
---	-----	---------------------------------------	-------

PRD 61



Plise Perde Gizli Köşe Takoğu
Pleated Curtain Hidden Corner Wedge

Paket İçi Adet Amount within package	400	Koli İçi Adet Amount within parcel	400
---	-----	---------------------------------------	-----

PRD 62



Plise Perde Kasa Montaj Plastik Klips
Pleat Curtain Case Mounting Plastic Clip

Paket İçi Adet Amount within package	400	Koli İçi Adet Amount within parcel	400
---	-----	---------------------------------------	-----

PRD 42



Yapışkan Profili Yay
Adhesive Profile Spring

Paket İçi Adet Amount within package	100	Koli İçi Adet Amount within parcel	500
---	-----	---------------------------------------	-----

PRD 30



İp Ayar Boylama Tezgahı
Rope Adjustment Lengthening Machine

PRD 31



Kumaş Delme Makinesi
Fabric Punching Machine

PRD 32



Kumaş Kesim Makinesi
Fabric Cutting Machine

PRD 33



Perçin Makinesi
Rivet Machine





T Profil
T Profile

Paket İçi Adet Quantity Per Package	10	Gramajı Weight	0,156 kg/m
--	----	-------------------	------------



20'lik T Profil
20 T Profile

Paket İçi Adet Quantity Per Package	10	Gramajı Weight	0,265 kg/m
--	----	-------------------	------------



Yaylı Yapışkan Profil
Spring Adhesive Profile

Paket İçi Adet Quantity Per Package	10	Gramajı Weight	0,102 kg/m
--	----	-------------------	------------



Small T Profil
Small T Profile

Paket İçi Adet Quantity Per Package	10	Gramajı Weight	0,094 kg/m
--	----	-------------------	------------



Yaylı Portray Profil
Spring Portray Profile

Paket İçi Adet Quantity Per Package	10	Gramajı Weight	0,076 kg/m
--	----	-------------------	------------



Çiftli Orta Profil
Double Middle Profile

Paket İçi Adet Quantity Per Package	10	Gramajı Weight	0,252 kg/m
--	----	-------------------	------------



Portray Yapışkan Profil
Adhesive Profile

Paket İçi Adet Amount within package	10	Gramajı Weight	0,105 kg/m
---	----	-------------------	------------



Plise Perde Kasa Profil
Pleated Curtain Case Profile

Paket İçi Adet Amount within package	6	Gramajı Weight	0,451 kg/m
---	---	-------------------	------------



Etekli T Profil
Extended T Profile

Paket İçi Adet Amount within package	10	Gramajı Weight	0,162 kg/m
---	----	-------------------	------------

Alüminyum Renk Seçeneği

Aluminum Color Options

9016

Beyaz
White



Eloksal Boyalı
Anodized Painted



Bronz Boyalı
Bronze Painted

8003

Altın Meşe
Golden Oak

8016

Maun
Mahogany

7016

Antrasit Gri
Anthracite Gray

9005

Siyah
Black



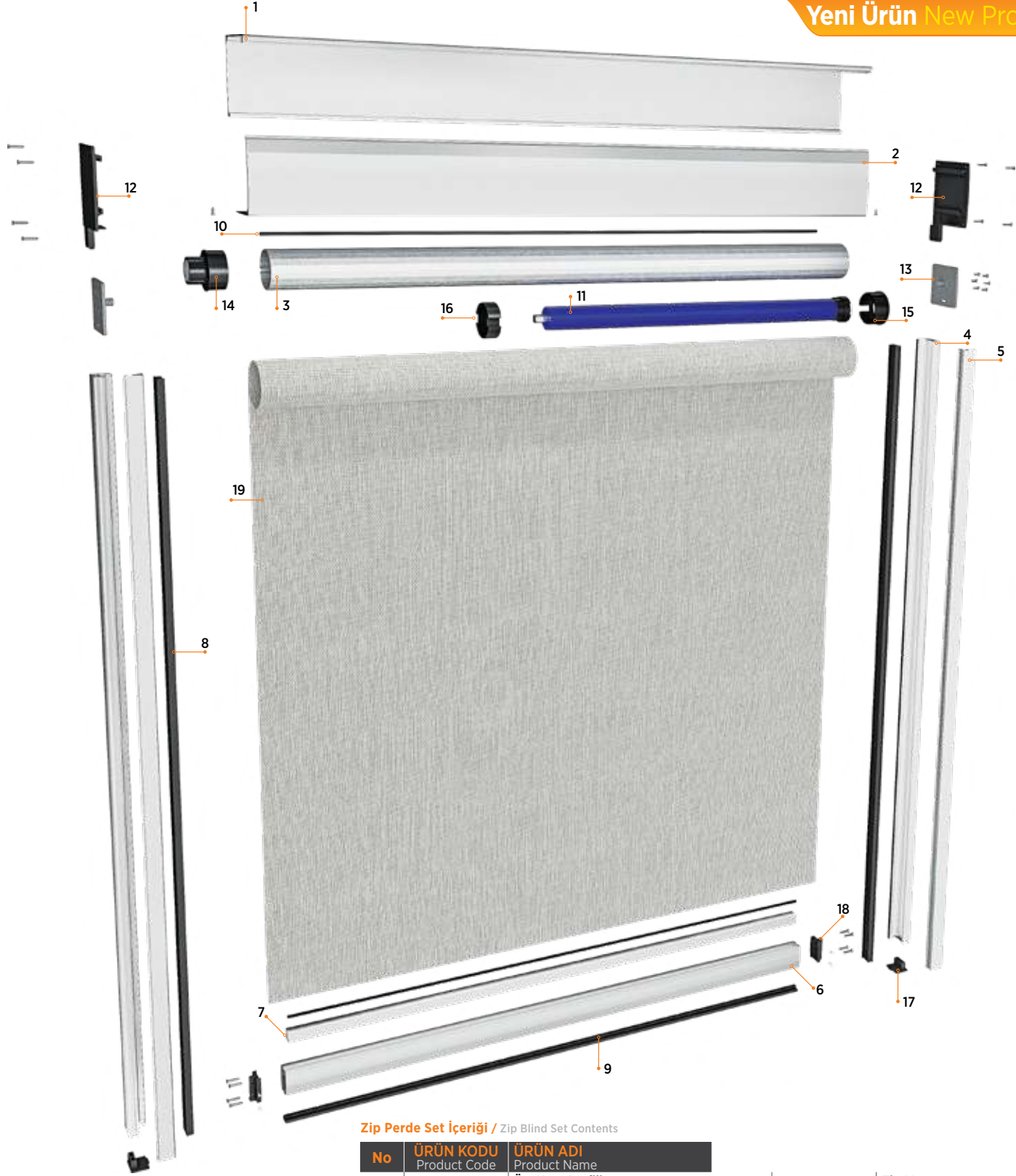

Zip Perde Set İçeriği / Zip Blind Set Contents

No	ÜRÜN KODU Product Code	ÜRÜN ADI Product Name
1	7150	Üst Kasa Profili Upper Case Profile
2	7151	Üst Kasa Kapak Profili Upper Case Cover Profile
3	ZP 13	Sac Tambur Borusu Sheet Drum Tube
4	251	Yan Kasa Profili Side Case Profile
5	252	Yan Kasa Kapak Profili Side Case Cover Profile
6	250	Kanat Profili Wing Profile
7	ZP 15	5x20 Lama Demir 5x20 Blade Iron
8	ZP 09	Fermuar Aparatı Zipper Apparatus
9	ZP 10	Kanat Contası Wing Seal
10	ZP 11	Perde Plastiği Curtain Plastic

11	-	Zip Motor Zip Engine
12	ZP 01	Üst Kasa Kapak - Sağ/Sol Upper Case Cover - Right/Left
13	ZP 02	Çelik Pimli Motor Bağlantı Parçası Steel Pinned Motor Connection Part
14	ZP 03	Rulmanlı Tambur Bağlantı Bearing Drum Connection
15	ZP 04	Motorlu Tambur Bağlantı Motorized Drum Connection
16	ZP 05	Rotor Aktarma Parçası Rotor Transmission Part
17	ZP 06	Yan Kasa Kapakları - Sağ/Sol Side Case Covers - Right/Left
18	ZP 07	Kanat Kapakları Wing Covers
19	-	Zip Perde Zip Blind

Zip perdeler, özellikle evler, restoranlar, kafeler, oteller ve ticari binalar gibi birçok farklı mekan için popüler bir seçenektir. Bu perdeler, iç mekan konforunu artırmak ve enerji tasarrufu sağlamak için kullanışlıdır.

Zip blinds are a popular choice for various settings, including homes, restaurants, cafes, hotels, and commercial buildings. They are useful for enhancing indoor comfort and promoting energy efficiency.

ZP 01

Siyah
Black



Üst Kasa Kapak - Sağ/Sol
Upper Case Cover - Right/Left

Paket İçi Adet Quantity Per Package	10	Koli İçi Adet Quantity Per Box	20
--	----	-----------------------------------	----

ZP 02

Gri
Grey



Çelik Pimli Motor Bağlantı Parçası
Steel Pinned Motor Connection Part

Paket İçi Adet Quantity Per Package	20	Koli İçi Adet Quantity Per Box	20
--	----	-----------------------------------	----

ZP 03

Siyah
Black



Rulmanlı Tambur Bağlantı
Bearing Drum Connection

Paket İçi Adet Quantity Per Package	10	Koli İçi Adet Quantity Per Box	10
--	----	-----------------------------------	----

ZP 04

Siyah
Black



Motorlu Tambur Bağlantı
Motorized Drum Connection

Paket İçi Adet Quantity Per Package	10	Koli İçi Adet Quantity Per Box	10
--	----	-----------------------------------	----

ZP 05

Siyah
Black



Rotor Aktarma Parçası
Rotor Transmission Part

Paket İçi Adet Quantity Per Package	10	Koli İçi Adet Quantity Per Box	10
--	----	-----------------------------------	----

ZP 06

Siyah
Black



Yan Kasa Kapakları - Sağ/Sol
Side Case Covers - Right/Left

Paket İçi Adet Quantity Per Package	10	Koli İçi Adet Quantity Per Box	20
--	----	-----------------------------------	----

ZP 07

Siyah
Black



Kanat Kapak
Wing Cover

Paket İçi Adet Quantity Per Package	40	Koli İçi Adet Quantity Per Box	40
--	----	-----------------------------------	----

ZP 09

Siyah
Black



Fermuar Aparatı
Zipper Apparatus

Paket İçi Adet Quantity Per Package	20	Koli İçi Adet Quantity Per Box	20
--	----	-----------------------------------	----

ZP 10

Siyah
Black



Kanat Contası
Wing Seal

Paket İçi Adet Quantity Per Package	125 m	Koli İçi Adet Quantity Per Box	125 m
--	-------	-----------------------------------	-------

ZP 11

Siyah
Black



Perde Plastiği
Curtain Plastic

Paket İçi Adet Quantity Per Package	1.500 m	Koli İçi Adet Quantity Per Box	1.500 m
--	---------	-----------------------------------	---------

ZP 15



5x20 Lama Demir
5x20 Blade Iron

Paket İçi Adet Quantity Per Package	0,800 kg/m	Gramajı Weight	0,800 kg/m
--	------------	-------------------	------------

ZP 8

Siyah
Black



Perde Fermuarı
Blind Zipper

Paket İçi Adet Quantity Per Package	200 m	Koli İçi Adet Quantity Per Box	200 m
--	-------	-----------------------------------	-------

ZP 14 **Somfy**
somfy.



Motor (35 Nm)
Engine (35 Nm)

KMD 1 **Somfy**
somfy.



Kumanda (Tekli)
Engine Remote Control (Mono)

KMD 2 **Somfy**
somfy.



Kumanda (Çoklu)
Engine Remote Control (Multi)

ZP 16 **A-OK**
A-OK



Motor (20-40 Nm)
Engine (20-40 Nm)

KMD 3 **A-OK**
A-OK



Kumanda (Tekli)
Engine Remote Control (Mono)

KMD 4 **A-OK**
A-OK



Kumanda (Çoklu)
Engine Remote Control (Multi)



Güneş Işığı Kontrolü:

Zip perdeler, güneş ışığını isteğe bağlı olarak engelleyebilir veya iç mekana geçirilebilir. Bu, iç mekanın aydınlatmasını ve sıcaklığını ayarlamak için kullanışlıdır.

Sunlight Control:

Zip blinds can either block or allow sunlight to enter the interior as desired, making it convenient for adjusting indoor lighting and temperature.



Rüzgar Dayanıklılığı:

Bu perdeler, dayanıklı ve rüzgarlı hava koşullarına karşı dirençli olarak tasarlanır. Rüzgarla temas ettiğinde dengeli ve sabit kalırlar.

Wind Resistance:

These blinds are designed to withstand strong and windy weather conditions, remaining stable even when in contact with the wind.



Sineklik İşlevi:

Zip perdeler, açık havada oturma alanları veya teraslar için idealdir. Aynı zamanda sineklik işlevi görebilir ve böceklerin içeri girmesini engelleyebilir.

Insect Protection:

Zip blinds are ideal for outdoor seating areas or terraces, as they can also function as insect screens, preventing bugs from entering.



Uzun Ömür:

Kaliteli malzemelerle yapıldığında, zip perdeler uzun yıllar boyunca dayanıklılık ve performans sunabilirler.

Longevity:

When made from high-quality materials, zip blinds can offer durability and long-lasting performance.





250

Kanat Profili
Wing Profile

Paket İçi Adet Quantity Per Package	3	Gramajı Weight	1,288 kg/m
--	---	-------------------	------------



251

Yan Kasa Profili
Side Case Profile

Paket İçi Adet Quantity Per Package	6	Gramajı Weight	0,572 kg/m
--	---	-------------------	------------



252

Yan Kasa Kapak Profili
Side Case Cover Profile

Paket İçi Adet Quantity Per Package	10	Gramajı Weight	0,313 kg/m
--	----	-------------------	------------



7150

Üst Kasa Profili
Upper Case Profile

Paket İçi Adet Quantity Per Package	2	Gramajı Weight	1,776 kg/m
--	---	-------------------	------------



7151

Üst Kasa Kapak Profili
Upper Case Cover Profile

Paket İçi Adet Quantity Per Package	2	Gramajı Weight	1,475 kg/m
--	---	-------------------	------------



ZP 13

Sac Tambur Borusu
Sheet Drum Tube

Paket İçi Adet Quantity Per Package	1	Gramajı Weight	2,110 kg/m
--	---	-------------------	------------



Zip Perde

Zip perde sistemleri, dış mekanları veya büyük cam yüzeyleri rüzgar, güneş ışığı ve böcekler gibi dış etkenlere karşı korumak ve kontrol altına almak için kullanılan özel bir pencere kaplama çözümdür. Zip perdeler, aynı zamanda "screen perdeleri" olarak da adlandırılır ve aşağıdaki özelliklere sahiptir:

Zip Blinds

Zip blind systems are a specialized window covering solution used to protect and control outdoor spaces or large glass surfaces from external factors such as wind, sunlight, and insects. Zip blinds are also called as "screen blinds" and have the following features:

Fonksiyonellik:

Zip perdeler, güneş ışığına karşı koruma sağlar ve iç mekan sıcaklığını kontrol etmek için kullanılır. Aynı zamanda yağmur, rüzgar ve böcekler gibi dış etkenlere karşı da koruma sunar.

Functionality:

Zip blinds provide protection against sunlight and are used to control indoor temperatures. They also offer protection against external elements like rain, wind, and insects.



Estetik Tasarım:

Zip perdeler, modern ve şık bir görünüme sahiptir. Dikey yönde çalışabilen bir sistemle tasarlanırlar ve bu, farklı pencere türlerine uygunluk sağlar.

Aesthetic Design:

Zip blinds have a modern and stylish appearance and can be designed with a system that operates vertically, making them suitable for various types of windows.



Kullanım Kolaylığı:

Otomatik kontrol seçenekleri mevcuttur. Otomasyon, kullanım kolaylığı sağlar ve perdelerin istenen pozisyonda sabit kalmasını sağlar.

Ease of Use:

Zip blinds come with automatic options, providing convenience and allowing the blinds to stay in the desired position.

ALÜMİNYUM PROFİL GRUBU

Aluminium Profile Group

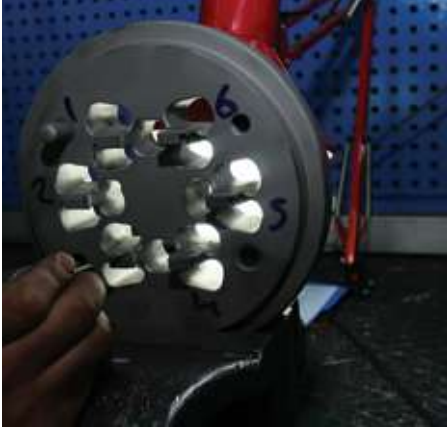

ISO 9001 | ISO 14001 | OHSAS 18001

GOLD SERİ PLİSE SİNEKLİK / GOLD SERIES PLAİT FLY SCREEN

304

0,318 kg/m

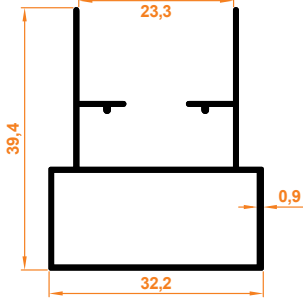

Gold Kasa Profil
Gold Case Profile

Paket İçi Adet
Quantity Per Package | 10

305

0,330 kg/m

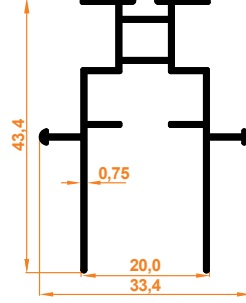

Gold Kanat Profil
Gold Wing Profile

Paket İçi Adet
Quantity Per Package | 10

STAR SERİ PLİSE SİNEKLİK / STAR SERIES PLAİT FLY SCREEN

356

0,271 kg/m

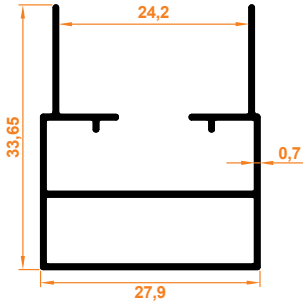

Star Kasa Profil
Star Case Profile

Paket İçi Adet
Quantity Per Package | 10

307

0,304 kg/m

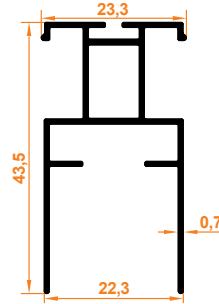

Star Kanat Profil
Star Wing Profile

Paket İçi Adet
Quantity Per Package | 10

JUNIOR SERİ PLİSE SİNEKLİK / JUNIOR SERIES PLAİT FLY SCREEN

306

0,243 kg/m

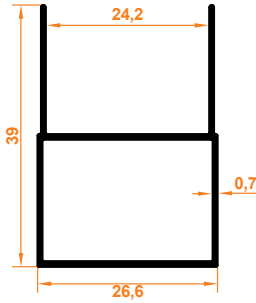

Junior Kasa Profil
Junior Case Profile

Paket İçi Adet
Quantity Per Package | 10

307

0,304 kg/m

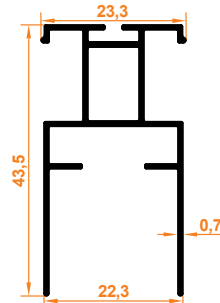

Junior Kanat Profil
Junior Wing Profile

Paket İçi Adet
Quantity Per Package | 10

345

0,162 kg/m

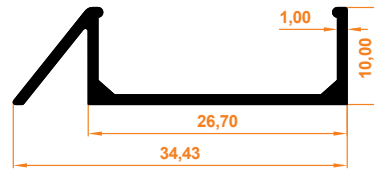

Junior Eşiksiz Kasa Profil
Junior Case Profile without Threshold

Paket İçi Adet
Quantity Per Package | 12

354

0,363 kg/m

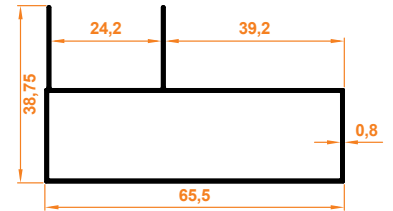

Süper Orta Kasa Profili
Super Middle Case Profile

Paket İçi Adet
Quantity Per Package | 10

SLIM SERİ PLİSE SİNEKLİK / SLIM SERIES PLAİT FLY SCREEN

300

0,218 kg/m

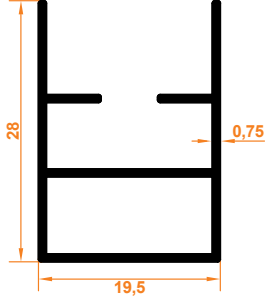

Slim Kasa Profil
Slim Case Profile

Paket İçi Adet
Quantity Per Package | 10

358

0,111 kg/m

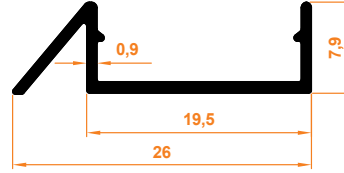

Slim Eşiksiz Profil
Slim Profile without Threshold

Paket İçi Adet
Quantity Per Package | 10

359

0,321 kg/m

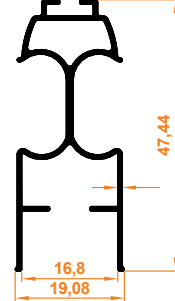

Slim Kant Profil
Slim Wing Profile

Paket İçi Adet
Quantity Per Package | 10

NOBEL SERİ PLİSE SİNEKLİK / NOBEL SERIES PLAİT FLY SCREEN

335

0,345 kg/m

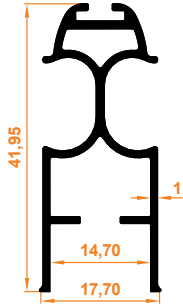

Nobel Kanat Profili
Nobel Wing Profile

Paket İçi Adet
Quantity Per Package | 10

355

0,098 kg/m

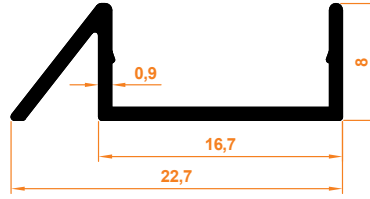

Nobel Eşiksiz Profili
Nobel Profile without Threshold

Paket İçi Adet
Quantity Per Package | 10

338

0,250 kg/m

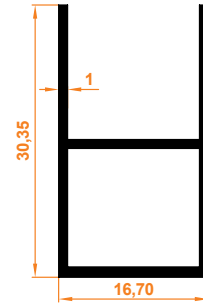

Nobel Kasa Profili
Nobel Case Profile

Paket İçi Adet
Quantity Per Package | 10

SÜPER SERİ PLİSE SİNEKLİK / SUPER SERIES PLAİT FLY SCREEN

320

0,303 kg/m

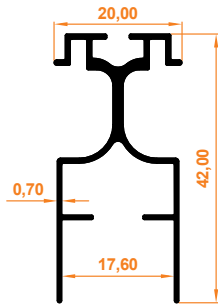

Süper Seri Kanat Profili
Super Wing Profile

Paket İçi Adet
Quantity Per Package | 10

316

0,248 kg/m

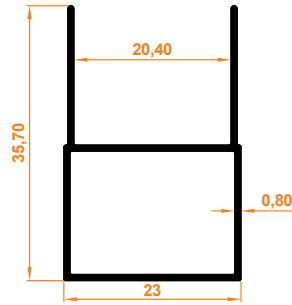

Süper Seri Kasa Profili
Super Case Profile

Paket İçi Adet
Quantity Per Package | 10

325

0,469 kg/m

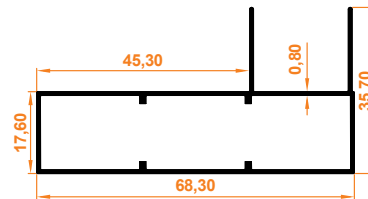

Süper Büyük Kasa Profili
Super Big Case Profile

Paket İçi Adet
Quantity Per Package | 4

354

0,363 kg/m

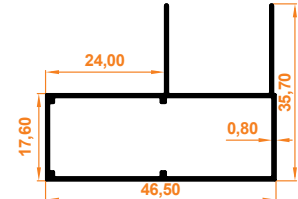

Süper Orta Kasa Profili
Super Middle Case Profile

Paket İçi Adet
Quantity Per Package | 6

NOBEL SERİ İÇTEN MONTAJLI PLİSE SİNEKLİK / NOBEL SERIES INTERNAL MOUNTED PLAIT FLY SCREEN

337

0,338 kg/m

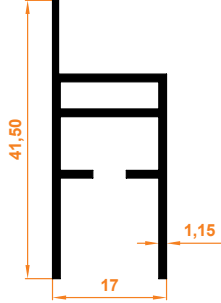

Nobel İçten Montajlı Kasa Profili
Nobel Internal Mounted Case Profile

Paket İçi Adet
Quantity Per Package

10

335

0,345 kg/m

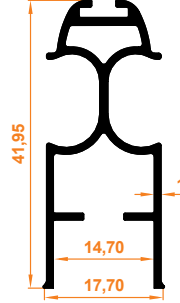

Nobel Kanat Profili
Nobel Wing Profile

Paket İçi Adet
Quantity Per Package

10

SLIM SERİ İÇTEN MONTAJLI PLİSE SİNEKLİK / SLIM SERIES INTERNAL MOUNTED PLAIT FLY SCREEN

317

0,272 kg/m

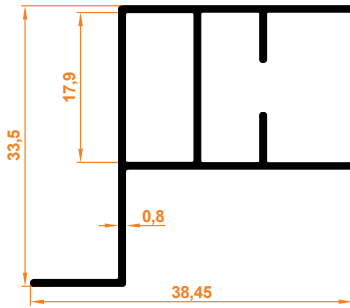

Kasa Profili
Case Profile

Paket İçi Adet
Quantity Per Package

10

359

0,321 kg/m

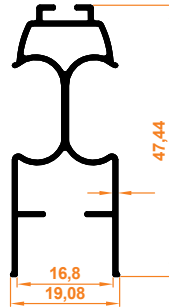

Slim Kanat Profili
Slim Wing Profile

Paket İçi Adet
Quantity Per Package

10

İÇTEN MONTAJLI SABİT SİNEKLİK / INTERNAL MOUNTED FIXED FLY SCREEN

405

0,256 kg/m

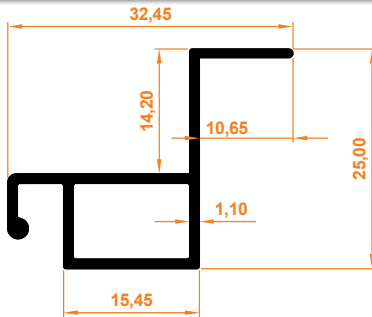

Kasa Profili
Case Profile

Paket İçi Adet
Quantity Per Package

10

AYKİM SERİ SİNEKLİK / AYKİM SERIES FLY SCREEN

309

0,374 kg/m

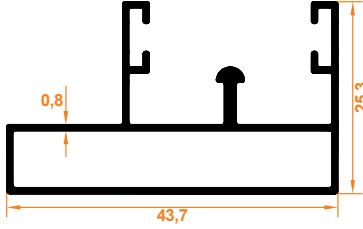

Aykim Kasa Profil
Aykim Case Profile

Paket İçi Adet
Quantity Per Package

8

310

0,315 kg/m

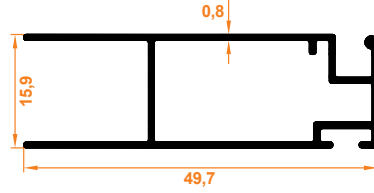

Aykim Hareketli Profil
Aykim Sliding Profile

Paket İçi Adet
Quantity Per Package

10

PLATİN SERİ SİNEKLİK / PLATİN SERIES FLY SCREEN

321

0,352 kg/m

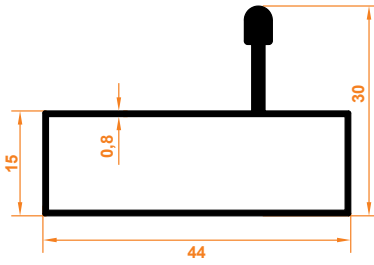

Platin Tekli Kasa Profil
Platin Single Case Profile

Paket İçi Adet
Quantity Per Package

8

322

0,455 kg/m

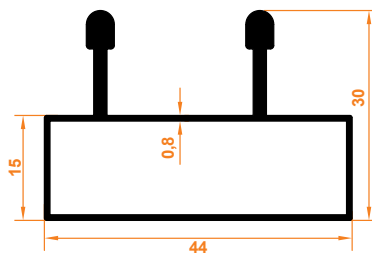

Platin Çiftli Kasa Profil
Platin Double Case Profile

Paket İçi Adet
Quantity Per Package

6

323

0,506 kg/m

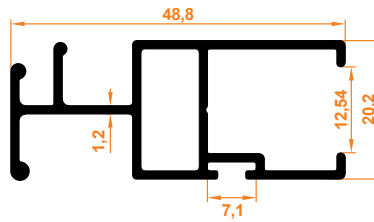

Platin Kanat Profil
Platin Wing Profile

Paket İçi Adet
Quantity Per Package

10

360

0,306 kg/m

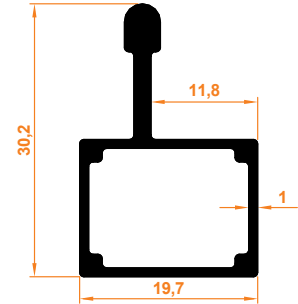

Platin Tekli Slim Kasa Profil
Platin Single Case Slim Profile

Paket İçi Adet
Quantity Per Package

10

DÜZ SİNEKLİK PROFİL GRUBU
Flat Fly Screen Profile Group

400

0,105 kg/m

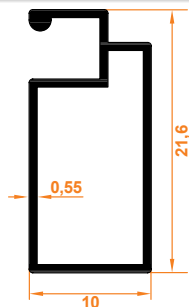

10x20 Sineklik
10x20 Fly Screen

Paket İçi Adet
Quantity Per Package

20

401

0,142 kg/m

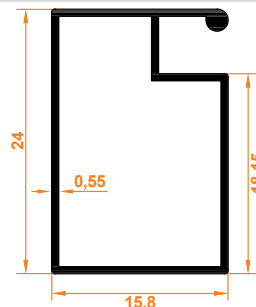

17x25 Sineklik
17x25 Fly Screen

Paket İçi Adet
Quantity Per Package

20

402

0,250 kg/m

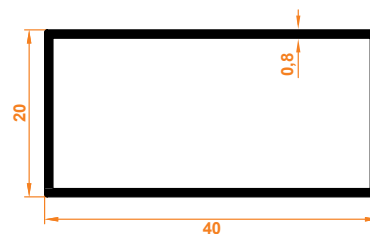

20x40 Sineklik
20x40 Fly Screen

Paket İçi Adet
Quantity Per Package

10

311

0,304 kg/m

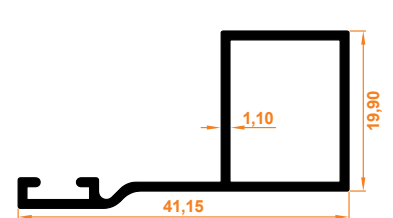

İçe Açılır Fitilli Sineklik Profili
Inward Foldable Flyscreen Profile

Paket İçi Adet
Quantity Per Package

10

STOR SİNEKLİK PROFİL GRUBU

Stor Fly Screen Profile Group

407

0,342 kg/m

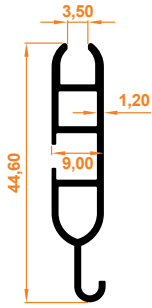

Stor Kanat Profil
Stor Wing Profile

Paket İçi Adet
Quantity Per Package

6

408

0,286 kg/m

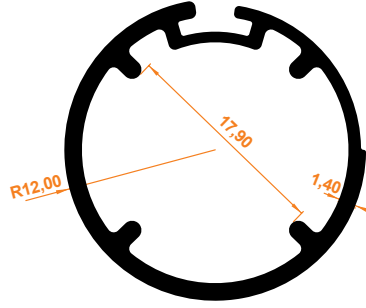

Stor Boru Profil
Stor Pipe Profile

Paket İçi Adet
Quantity Per Package

6

409

0,526 kg/m

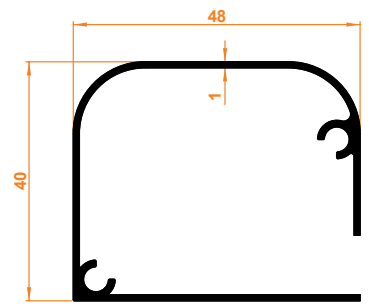

Stor Kasa Profil
Stor Case Profile

Paket İçi Adet
Quantity Per Package

6

410

0,413 kg/m

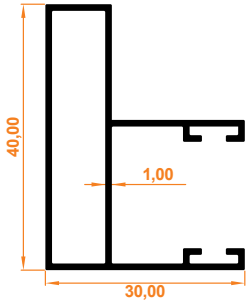

Stor Yan Kasa Profil
Stor Side Case Profile

Paket İçi Adet
Quantity Per Package

6

411

0,318 kg/m

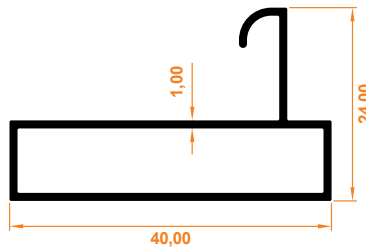

Stor Alt Kasa Profil
Stor Bottom Case Profile

Paket İçi Adet
Quantity Per Package

6

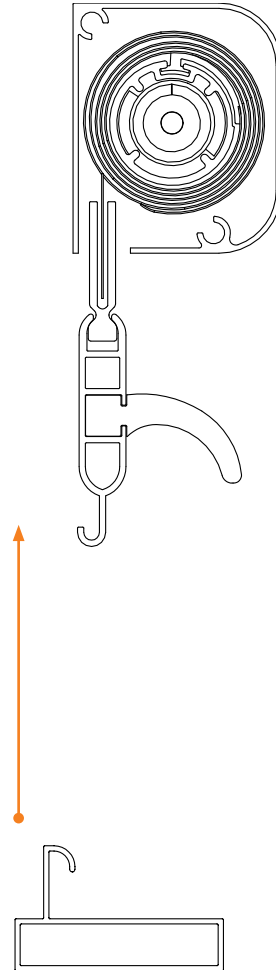
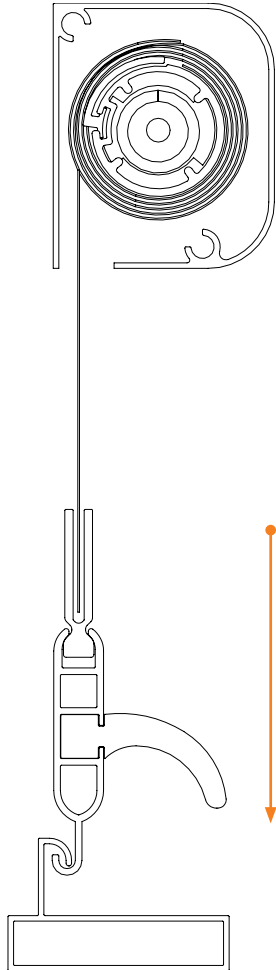

1

0,247 kg/m

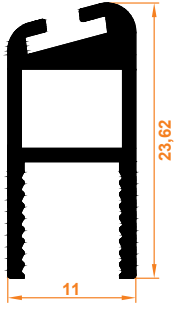

Büyük D Fitol
Big D Wick

Paket İçi Adet
Quantity Per Package

10

2

0,167 kg/m

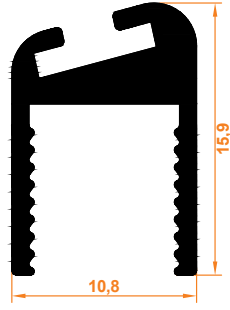

Küçük D Fitol
Small D Wick

Paket İçi Adet
Quantity Per Package

10

3

0,116 kg/m

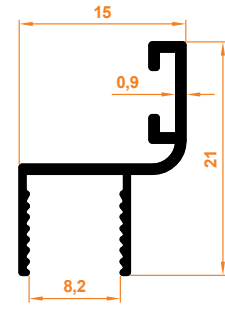

Küçük h Fitol
Small h Wick

Paket İçi Adet
Quantity Per Package

20

4

0,150 kg/m

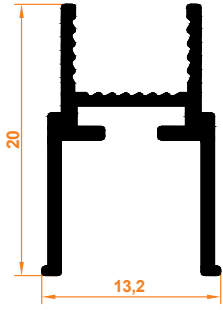

Orta H Fitol
Middle H Wick

Paket İçi Adet
Quantity Per Package

10

5

0,214 kg/m

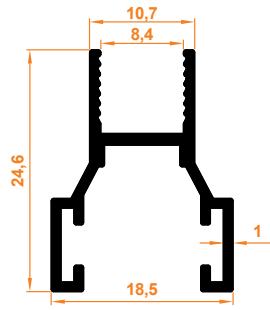

Büyük H Fitol
Big H Wick

Paket İçi Adet
Quantity Per Package

20

6

0,276 kg/m

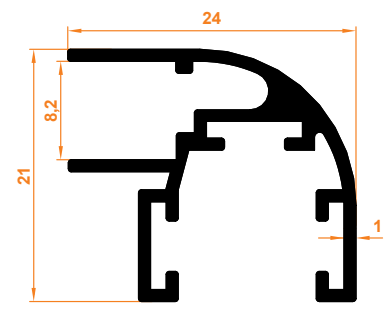

Köşe Dönüş Fitol
Corner Return Wick

Paket İçi Adet
Quantity Per Package

10

8 mm CAM BALKON PROFİL GRUBU

8 mm Glass Balcony Profile Group

101

0,078 kg/m

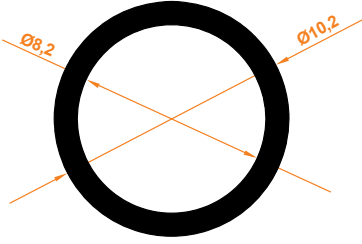

10'lu Stoplama
10 Stopping Profile

Paket İçi Adet
Quantity Per Package

25

104

0,717 kg/m

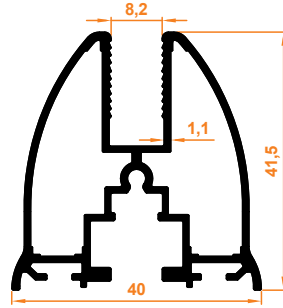

Gold Baza Profil
Gold Base Profile

Paket İçi Adet
Quantity Per Package

3

105

0,730 kg/m

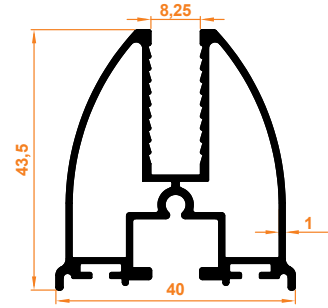

Firtına Baza Profil
Firtına Base Profile

Paket İçi Adet
Quantity Per Package

3

109

1,355 kg/m

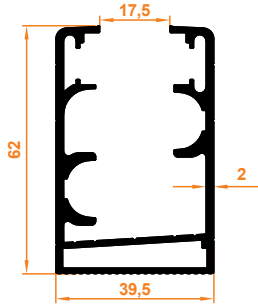

Düz Kasa Profil
Flat Case Profile

Paket İçi Adet
Quantity Per Package

3

110

1,396 kg/m

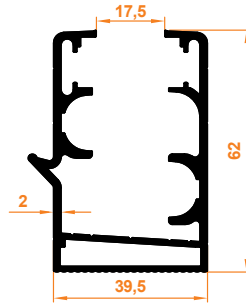

Oluklu Kasa Profil
Corrugated Case Profile

Paket İçi Adet
Quantity Per Package

3

100

0,441 kg/m

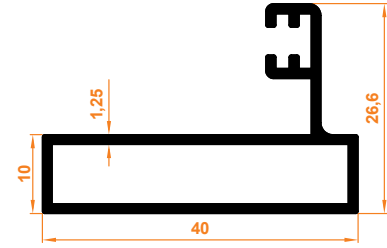

Dar Yan Dikme
Thin Side Column

Paket İçi Adet
Quantity Per Package

6

106

1,611 kg/m

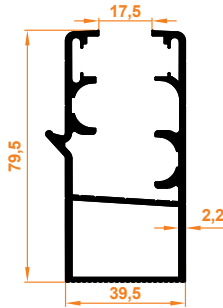

Oluklu Büyük Kasa Profil
Corrugated Big Case Profile

Paket İçi Adet
Quantity Per Package

3

107

1,570 kg/m

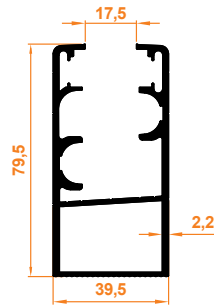

Büyük Düz Kasa Profil
Big Flat Case Profile

Paket İçi Adet
Quantity Per Package

3

108

0,457 kg/m

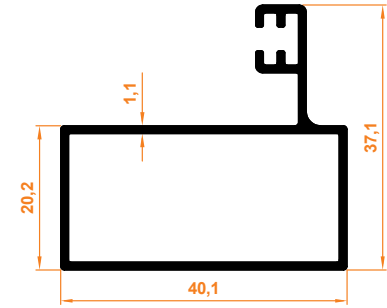

Geniş Yan Dikme
Thick Side Column Profile

Paket İçi Adet
Quantity Per Package

6

111

1,062 kg/m

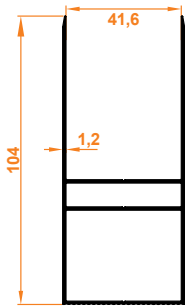

Stor Profil
Stor Profile

Paket İçi Adet
Quantity Per Package

3

135

0,517 kg/m

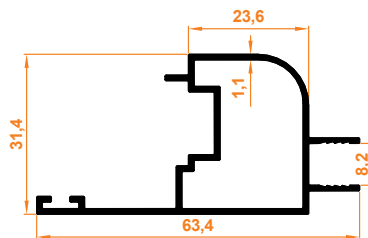

8 mm İspanyolet Profil
8 mm Espagnolette Profile

Paket İçi Adet
Quantity Per Package

4

136

0,343 kg/m

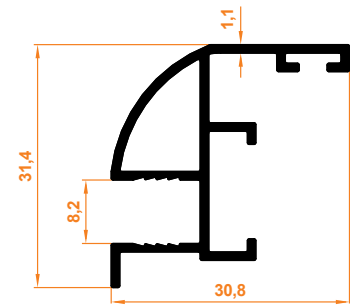

8 mm İspanyolet Profil Karşılığı
8 mm Espagnolette Combination Profile

Paket İçi Adet
Quantity Per Package

8

800

0,618 kg/m

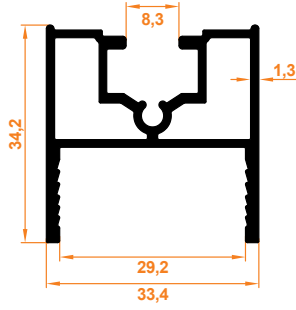

Baza Profil
Base Profile

Paket İçi Adet | 6
Quantity Per Package

801

0,321 kg/m

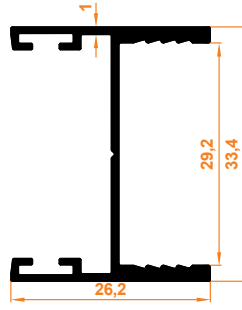

Düz Kapak Profil
Flat Cover Profile

Paket İçi Adet | 6
Quantity Per Package

802

0,327 kg/m

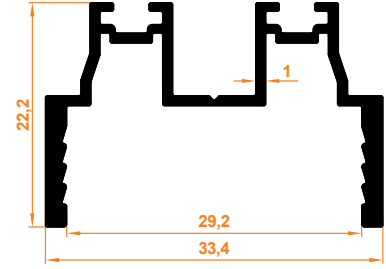

Düz Kapak Mentеше Profil
Flat Cover with Hinge Profile

Paket İçi Adet | 6
Quantity Per Package

803

0,445 kg/m

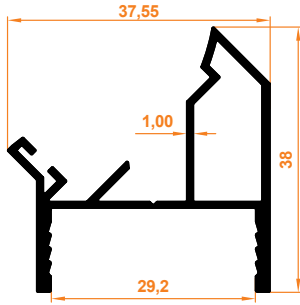

45° Dönüş Profil
45° Return Profile

Paket İçi Adet | 6
Quantity Per Package

804

0,378 kg/m

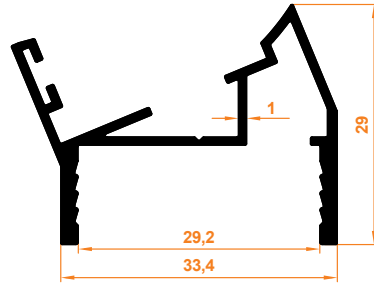

22,5° Dönüş Profil
22,5° Return Profile

Paket İçi Adet | 6
Quantity Per Package

805

0,366 kg/m

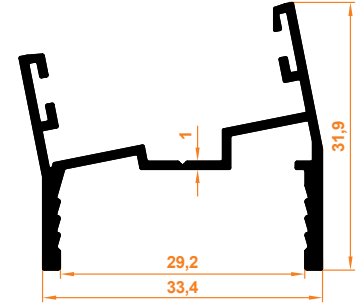

11° Dönüş Profil
11° Return Profile

Paket İçi Adet | 6
Quantity Per Package

806

0,475 kg/m

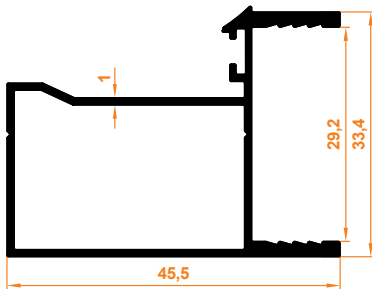

90° Dönüş Profil
90° Return Profile

Paket İçi Adet | 6
Quantity Per Package

807

0,346 kg/m

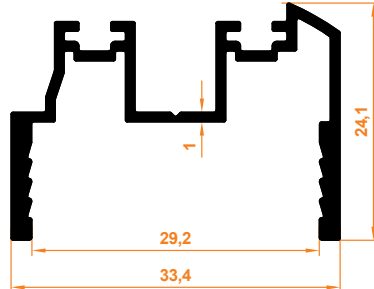

Açılı Dönüş Mentеше Profil
PopUp Return Hinge Profile

Paket İçi Adet | 6
Quantity Per Package

808

0,369 kg/m

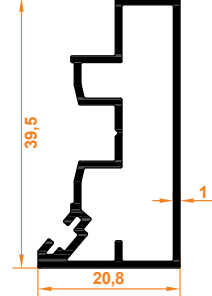

Yan Dikme Profil
Side Column Profile

Paket İçi Adet | 6
Quantity Per Package

809

0,328 kg/m

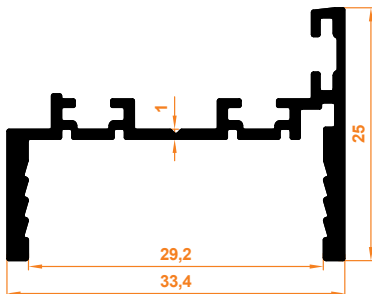

Sabit Cam Mentеше Profil
Stable Glass Hinge Profile

Paket İçi Adet | 6
Quantity Per Package

810

0,355 kg/m

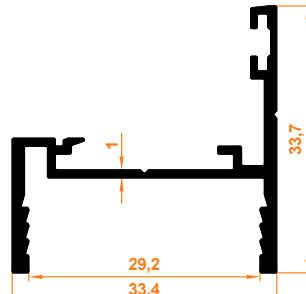

Sabit Cam Kilit Profil
Stable Glass Lock Profile

Paket İçi Adet | 6
Quantity Per Package

811

0,342 kg/m

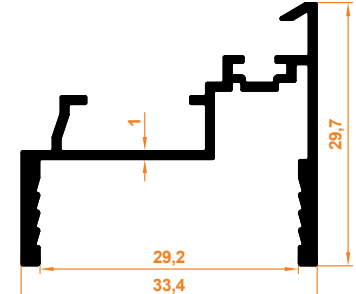

Sabit Cam Kilit Karşılığı Profil
Stable Glass Lock Prevention Profile

Paket İçi Adet | 6
Quantity Per Package

819

1,344 kg/m

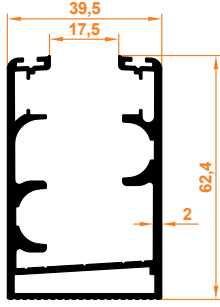

Düz Kasa Üstten Fitilli Profil
Flat Case Top Wicked Profile

Paket İçi Adet
Quantity Per Package

3

820

1,389 kg/m

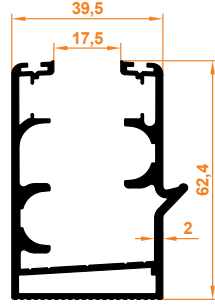

Oluklu Kasa Üstten Fitilli Profil
Corrugated Case Top Wicked Profile

Paket İçi Adet
Quantity Per Package

3

822

0,378 kg/m

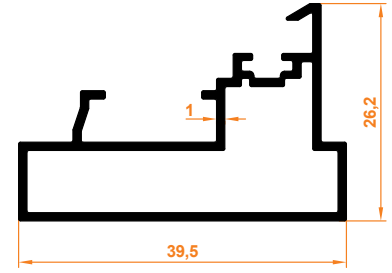

Açılır Dikme Profil
PopUp Column Profile

Paket İçi Adet
Quantity Per Package

6

816

1,577 kg/m

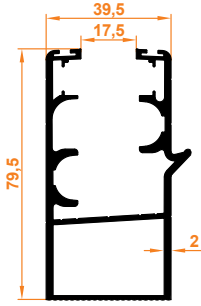

Üstten Fitilli Büyük Oluklu Kasa
Large Corrugated Case with Top Wick

Paket İçi Adet
Quantity Per Package

3

817

1,532 kg/m

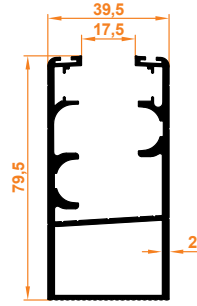

Üstten Fitilli Büyük Düz Kasa
Large Flat Case with Wed from Top

Paket İçi Adet
Quantity Per Package

3

815

0,100 kg/m

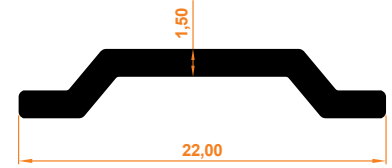

Tij Profil
Espagnolette Profile

Paket İçi Adet
Quantity Per Package

20

823

0,459 kg/m

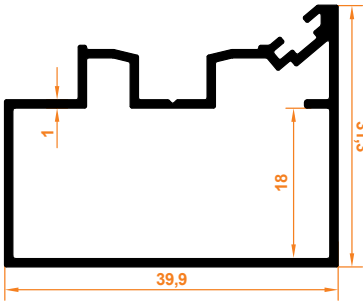

Geniş Yan Dikme
Wide Side Column

Paket İçi Adet
Quantity Per Package

6

824

0,583 kg/m

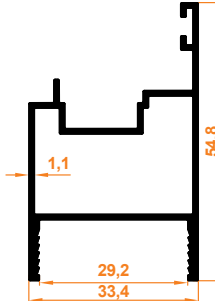

Sabit Cam İspanyolet Profil
Fixed Glass Espagnolette Profile

Paket İçi Adet
Quantity Per Package

6

825

0,356 kg/m

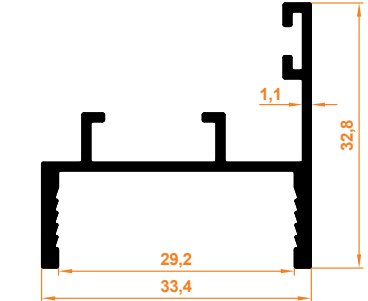

Sabit Cam İspanyolet Karşılık Profil
Fixed Glass Espagnolette Handle Provision Profile

Paket İçi Adet
Quantity Per Package

6

830

0,680 kg/m

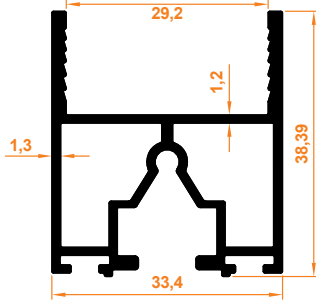

Fitilli Baza Profili
Wicked Base Profile

Paket İçi Adet | 6
Quantity Per Package

801

0,321 kg/m

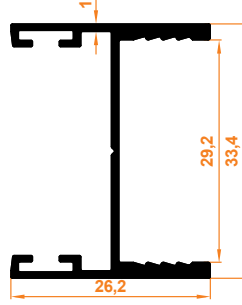

Düz Kapak Profili
Flat Cover Profile

Paket İçi Adet | 6
Quantity Per Package

802

0,327 kg/m

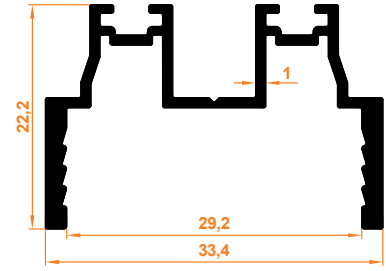

Düz Kapak Menteşe Profili
Flat Cover with Hinge Profile

Paket İçi Adet | 6
Quantity Per Package

803

0,445 kg/m

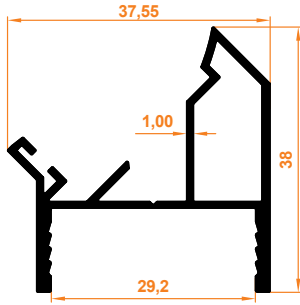

45° Dönüş Profili
45° Return Profile

Paket İçi Adet | 6
Quantity Per Package

804

0,378 kg/m

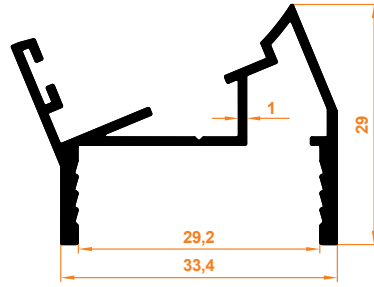

22,5° Dönüş Profili
22,5° Return Profile

Paket İçi Adet | 6
Quantity Per Package

805

0,366 kg/m

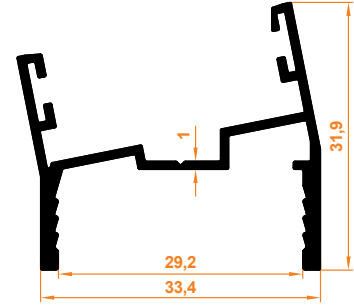

11° Dönüş Profili
11° Return Profile

Paket İçi Adet | 6
Quantity Per Package

806

0,475 kg/m

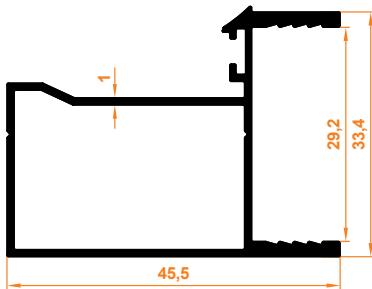

90° Dönüş Profili
90° Return Profile

Paket İçi Adet | 6
Quantity Per Package

807

0,346 kg/m

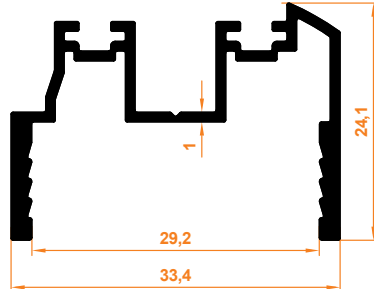

Açılı Dönüş Menteşe Profili
PopUp Return Hinge Profile

Paket İçi Adet | 6
Quantity Per Package

808

0,369 kg/m

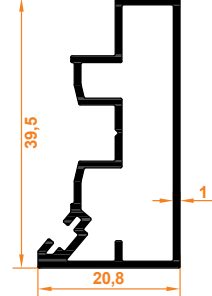

Yan Dikme Profili
Side Column Profile

Paket İçi Adet | 6
Quantity Per Package

809

0,328 kg/m

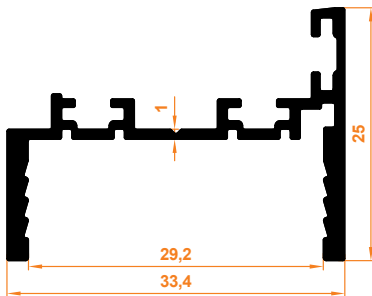

Sabit Cam Menteşe Profili
Stable Glass Hinge Profile

Paket İçi Adet | 6
Quantity Per Package

810

0,355 kg/m

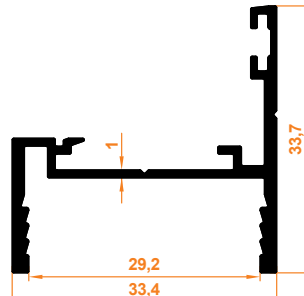

Sabit Cam Kilit Profili
Stable Glass Lock Profile

Paket İçi Adet | 6
Quantity Per Package

811

0,342 kg/m

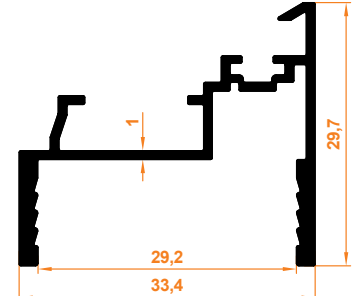

Sabit Cam Kilit Karşılığı Profili
Stable Glass Lock Prevention Profile

Paket İçi Adet | 6
Quantity Per Package

109

1,355 kg/m

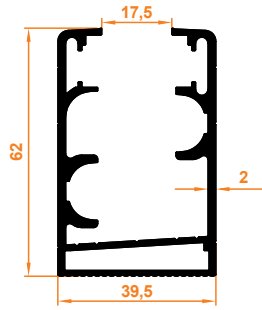

Düz Kasa Profil
Flat Case Profile

Paket İçi Adet
Quantity Per Package

3

110

1,396 kg/m

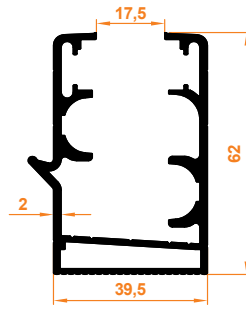

Oluklu Kasa Profil
Corrugated Case Profile

Paket İçi Adet
Quantity Per Package

3

822

0,378 kg/m

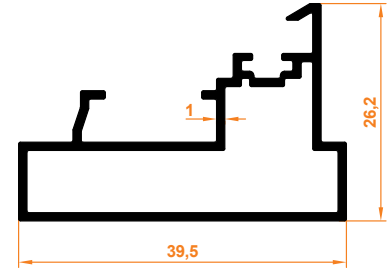

Açılır Dikme Profil
PopUp Column Profile

Paket İçi Adet
Quantity Per Package

6

106

1,611 kg/m

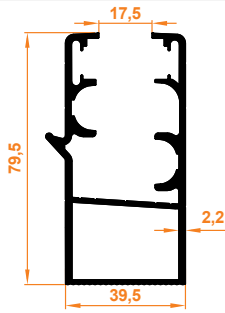

Oluklu Büyük Kasa Profil
Corrugated Big Case Profile

Paket İçi Adet
Quantity Per Package

3

107

1,570 kg/m

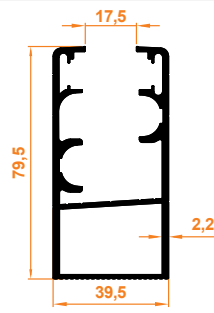

Büyük Düz Kasa Profil
Big Flat Case Profile

Paket İçi Adet
Quantity Per Package

3

815

0,100 kg/m

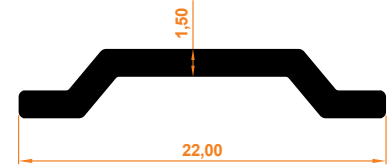

Tij Profil
Espagnolette Profile

Paket İçi Adet
Quantity Per Package

20

823

0,459 kg/m

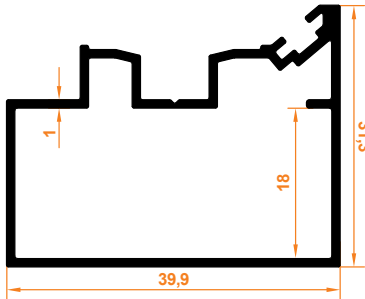

Geniş Yan Dikme
Wide Side Column

Paket İçi Adet
Quantity Per Package

6

824

0,583 kg/m

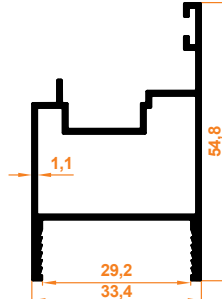

Sabit Cam İspanyolet Profil
Fixed Glass Espagnolette Profile

Paket İçi Adet
Quantity Per Package

6

825

0,356 kg/m

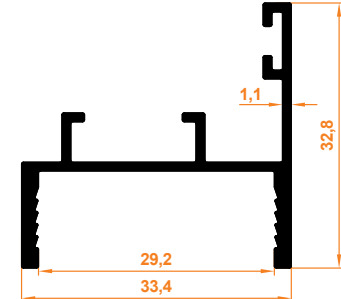

Sabit Cam İspanyolet Karşılık Profil
Fixed Glass Espagnolette Handle Provision Profile

Paket İçi Adet
Quantity Per Package

6

210

0,643 kg/m

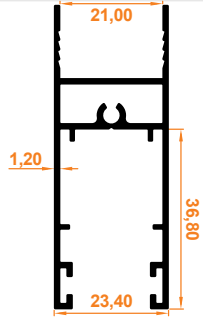

Sürme Baza Profil
Sliding Base Profile

Paket İçi Adet
Quantity Per Package

5

215

0,908 kg/m

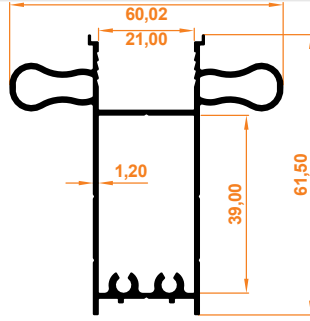

Çekme Koll Profil
Pull Handle Profile

Paket İçi Adet
Quantity Per Package

3

212

0,423 kg/m

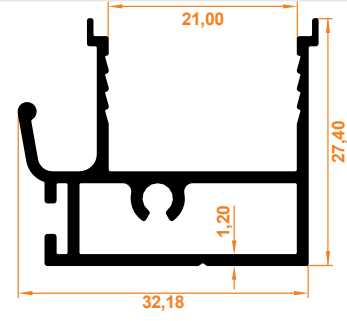

Kenet Profil
Clamp Profile

Paket İçi Adet
Quantity Per Package

6

211

0,301 kg/m

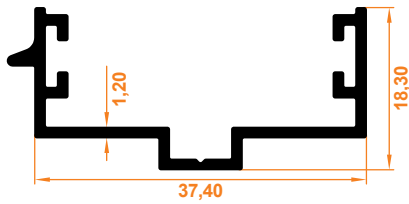

Birleştirme Karşılık Profil
Combination Provisions Profile

Paket İçi Adet
Quantity Per Package

6

213

0,974 kg/m

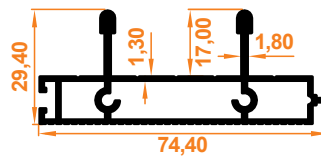

İkili Eşikli Alt Kasa Profil
Double Threshold Lower Case Profile

Paket İçi Adet
Quantity Per Package

4

222

1,333 kg/m

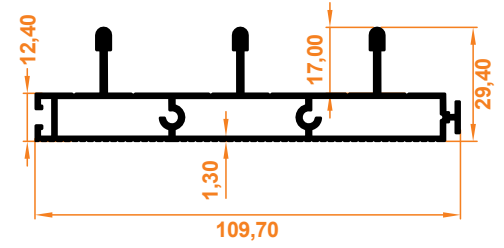

Üçlü Eşikli Alt Kasa Profil
Triple Threshold Lower Case Profile

Paket İçi Adet
Quantity Per Package

2

220

0,867 kg/m

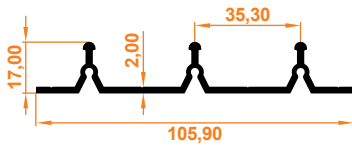

Üçlü Eşiksiz Alt Kasa Profil
Triple Bottom Case Profile without Threshold

Paket İçi Adet
Quantity Per Package

4

229

1,120 kg/m

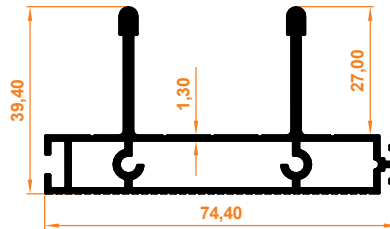

İkili Üst Kasa Profil
Double Upper Case Profile

Paket İçi Adet
Quantity Per Package

2

230

1,552 kg/m

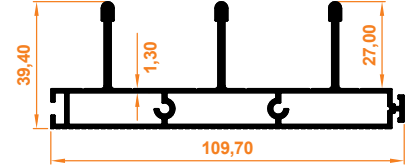

İkili Üçlü Kasa Profil
Triple Upper Case Profile

Paket İçi Adet
Quantity Per Package

2

221

1,156 kg/m

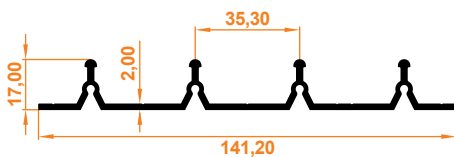

Dörtlü Eşiksiz Alt Kasa Profil
Quadruple Bottom Case Profile without Threshold

Paket İçi Adet
Quantity Per Package

2

214

0,587 kg/m

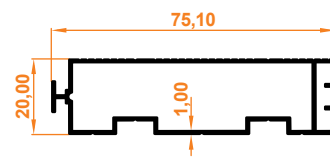

İkili Yan Kasa Profil
Double Side Case Profile

Paket İçi Adet
Quantity Per Package

4

223

0,792 kg/m

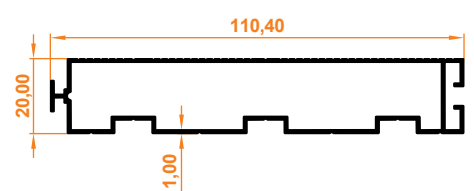

Üçlü Yan Kasa Profil
Triple Side Case Profile

Paket İçi Adet
Quantity Per Package

2

219

0,219 kg/m

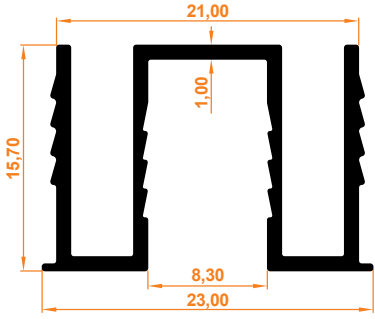

8 mm Cam Adaptörü
8mm Glass Adapter

Paket İçi Adet
Quantity Per Package

10

226

0,071 kg/m

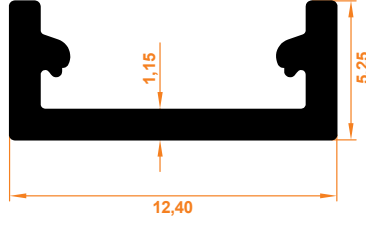

Kapatma Profil
Closing Profile

Paket İçi Adet
Quantity Per Package

20

227

0,751 kg/m

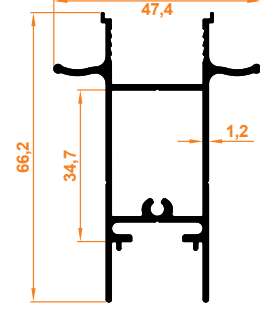

İspanyolet Çekme Kol Profili
Espagnolette Pull Handle Profile

Paket İçi Adet
Quantity Per Package

3

228

0,156 kg/m

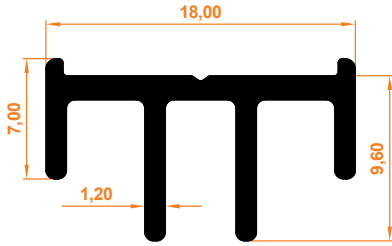

İspanyolet Karşılık Profili
Espagnolette Provision Profile

Paket İçi Adet
Quantity Per Package

10

Sürme Sistem Çalışma Mekanizması

Sliding System Operating Mechanism

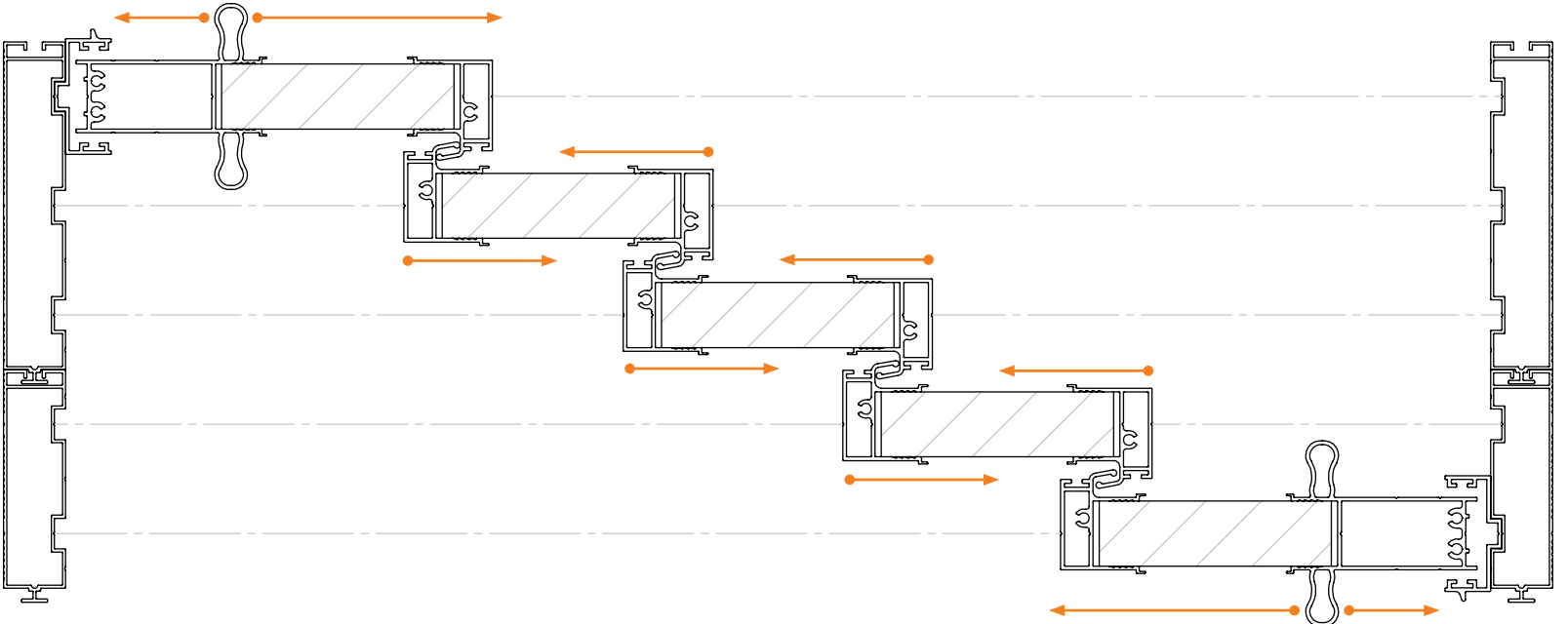

Sürme Sistem Çalışma Mekanizması

Sliding System Operating Mechanism

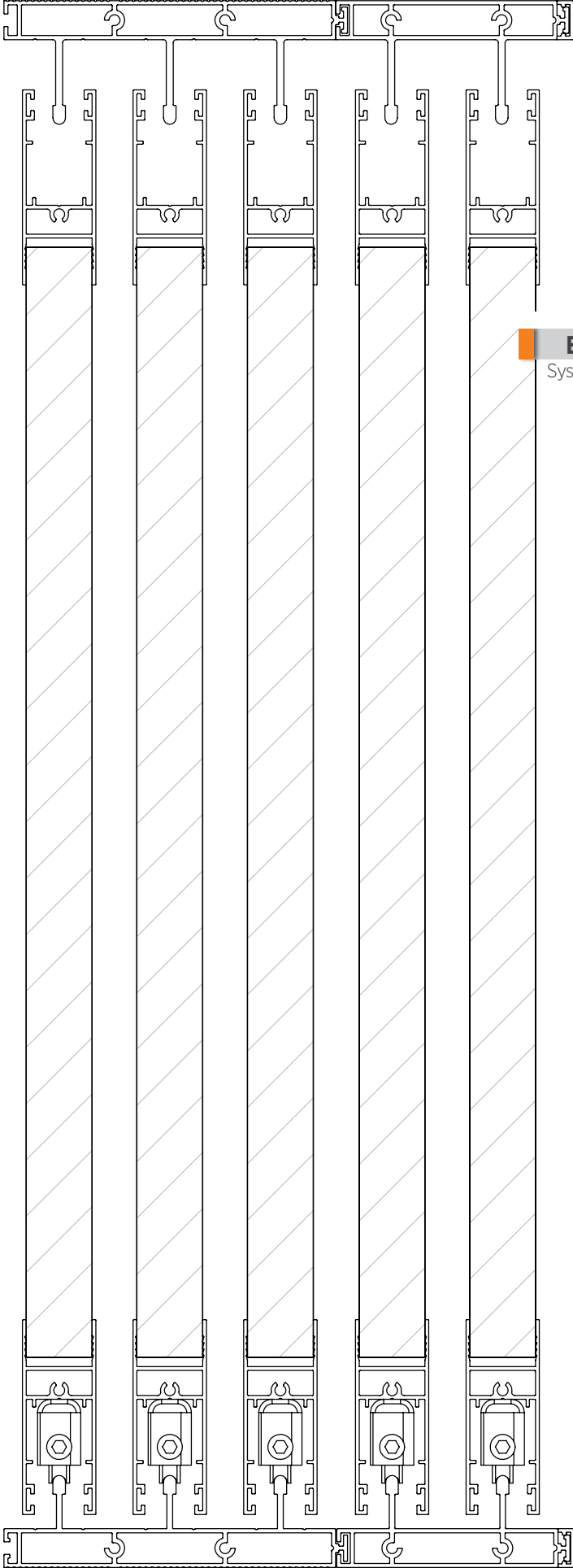

Eşikli Sistem

System with Treshold

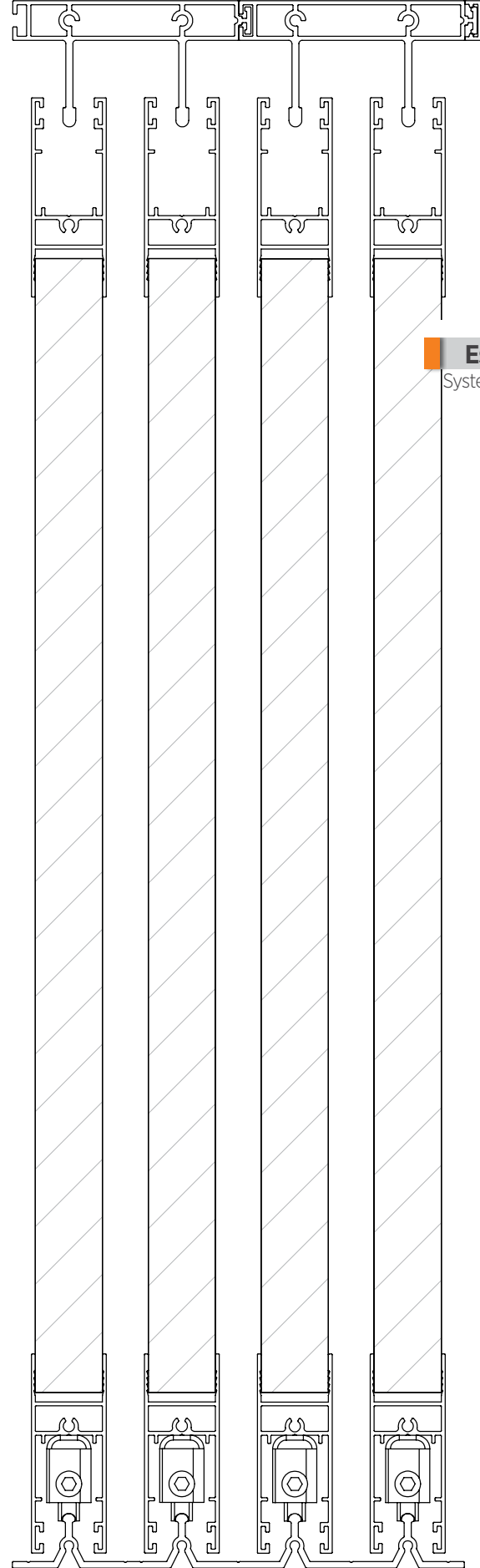

Eşiksiz Sistem

System without Treshold

140

0,563 kg/m

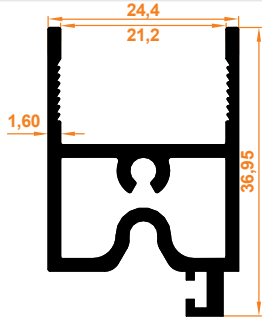

Sabit Panel Açılır Alt Baza Profil
Fixed Panel Pop-up Base Profile

Paket İçi Adet
Quantity Per Package | 6

164

0,842 kg/m

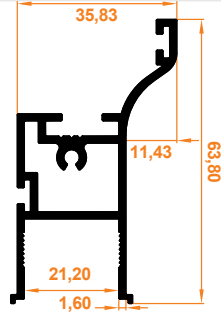

Sabit Panel Yan Dikme Profil
Fixed Panel Side Column Profile

Paket İçi Adet
Quantity Per Package | 4

142

0,750 kg/m

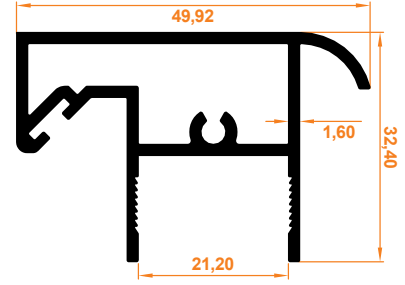

Sabit Panel Üst Baza Profil
Fixed Panel Top Base Profile

Paket İçi Adet
Quantity Per Package | 4

167

1,144 kg/m

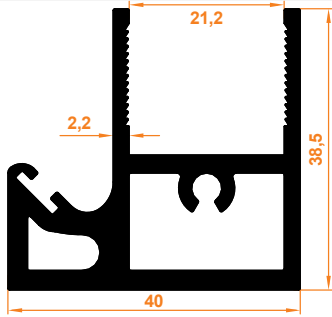

Kenet Baza Profil
Clamp Base Profile

Paket İçi Adet
Quantity Per Package | 4

144

0,434 kg/m

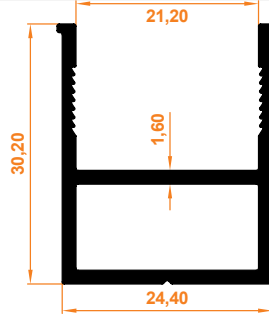

Hareketli Panel Yan Dikme Profil
Movable Panel Side Column Profile

Paket İçi Adet
Quantity Per Package | 6

145

0,579 kg/m

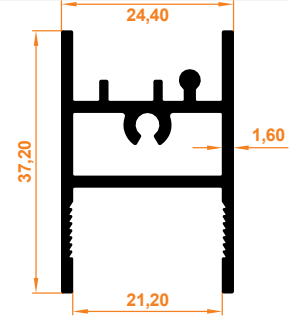

Küpeşte Baza Profil
Handrail Base Profile

Paket İçi Adet
Quantity Per Package | 6

146

0,741 kg/m

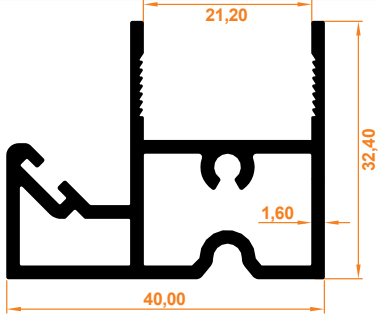

Hareketli Panel Açılır Alt Baza Profil
Movable Panel Pop-up Lower Base Profile

Paket İçi Adet
Quantity Per Package | 4

161

0,482 kg/m

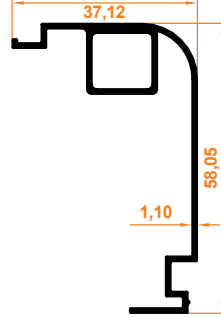

Ray Kapatma "T" Profil
Rail Closure "T" Profile

Paket İçi Adet
Quantity Per Package | 4

160

1,057 kg/m

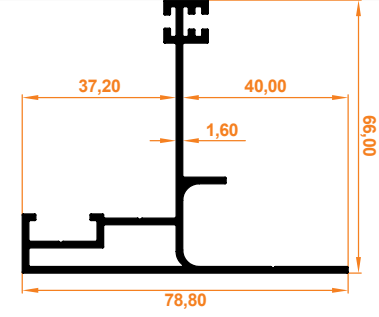

Yan Ray "T" Profil
Side Rail "T" Profile

Paket İçi Adet
Quantity Per Package | 2

166

0,144 kg/m

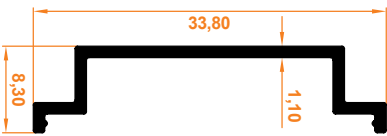

Açılımlı için Ray Kapatma 'L' Profil
Rail Closure 'L' Profile for Opening

Paket İçi Adet
Quantity Per Package | 10

162

0,703 kg/m

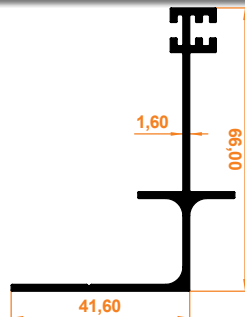

Yan Ray "L" Profil
Side Rail "L" Profile

Paket İçi Adet
Quantity Per Package | 4

GYT 28

2,110 kg/m

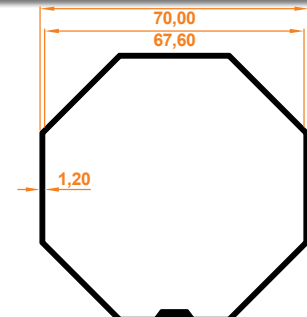

Sac Tambur Borusu
Sheet Drum Pipe

Paket İçi Adet
Quantity Per Package | 1

152

1,563 kg/m

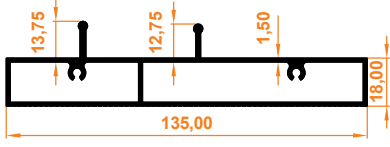

Alt Kasa
Guillotine Lower Case Profile

Paket İçi Adet | 2
Quantity Per Package

156

3,449 kg/m

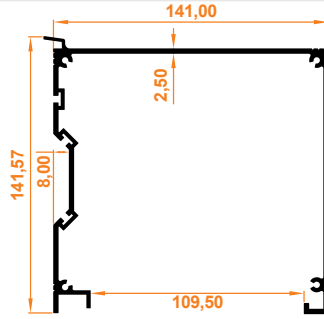

Üst Kasa Profil
Top Case Profile

Paket İçi Adet | 1
Quantity Per Package

153

0,864 kg/m



Üst Kasa Kapak Profil
Top Case Cover Profile

Paket İçi Adet | 2
Quantity Per Package

155

1,669 kg/m

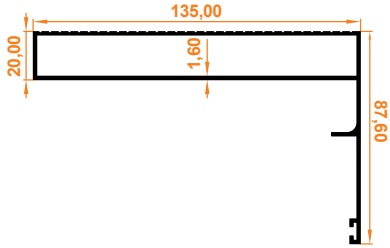

Yan Kasa Profil
Side Case Profile

Paket İçi Adet | 2
Quantity Per Package

154

0,759 kg/m

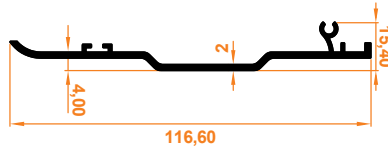

Küpeşte Profil
Handrail Profile

Paket İçi Adet | 2
Quantity Per Package

165

0,644 kg/m



Yan Kasa Kertme Profil
Side Case Notched Profile

Paket İçi Adet | 4
Quantity Per Package

158

0,510 kg/m

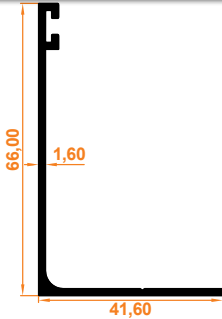

Açılımsız Tek Fıtil Yan Ray L Kasa Profil
Single Weatherstrips Without Opening Side L Case Profile

Paket İçi Adet | 4
Quantity Per Package

159

0,660 kg/m

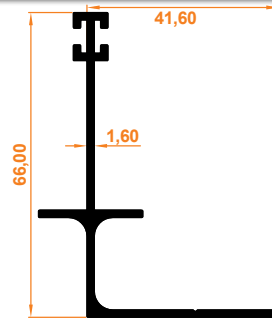

Açılımsız Çift Fıtil Yan Ray L Kasa Profil
Double Weatherstrips Without Opening Side L Case Profil

Paket İçi Adet | 4
Quantity Per Package

219

0,219 kg/m

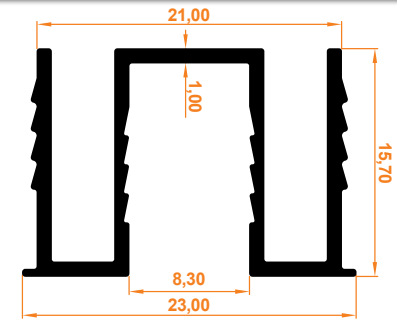

8 mm Cam Adaptörü
8mm Glass Adapter

Paket İçi Adet | 10
Quantity Per Package

149

0,162 kg/m

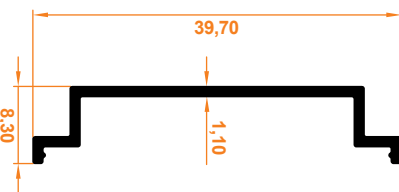

Açılımsız için Ray Kapatma 'L' Profil
Rail Closure 'L' Profile for Non-Opening

Paket İçi Adet | 10
Quantity Per Package

Giyotin Sistem Çalışma Mekanizması

Guillotine System Operating Mechanism

1. Kademe - Level 1

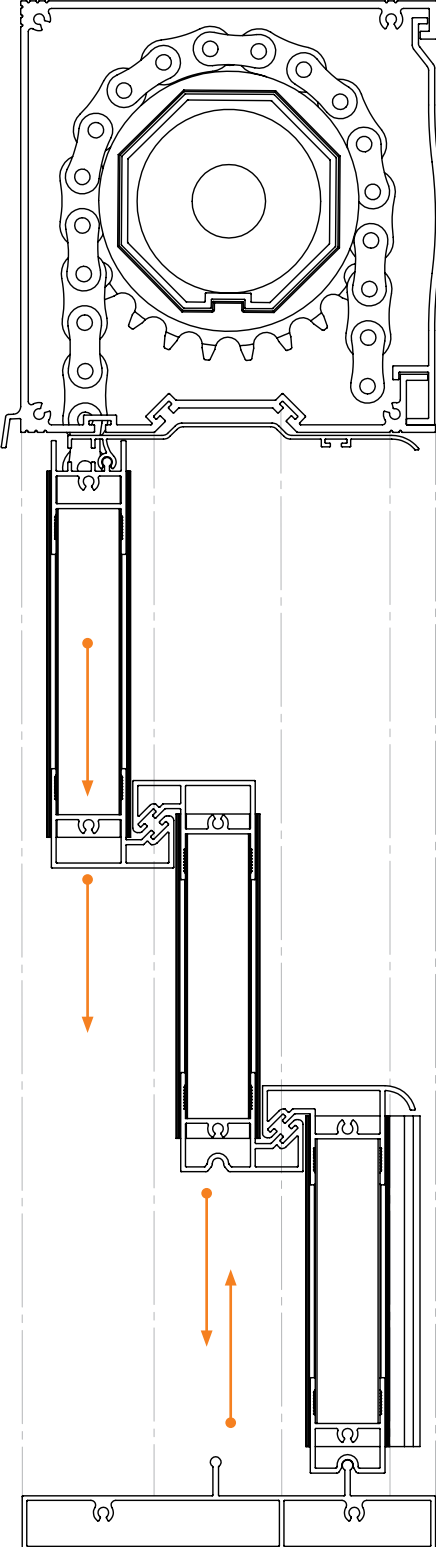

2. Kademe - Level 2

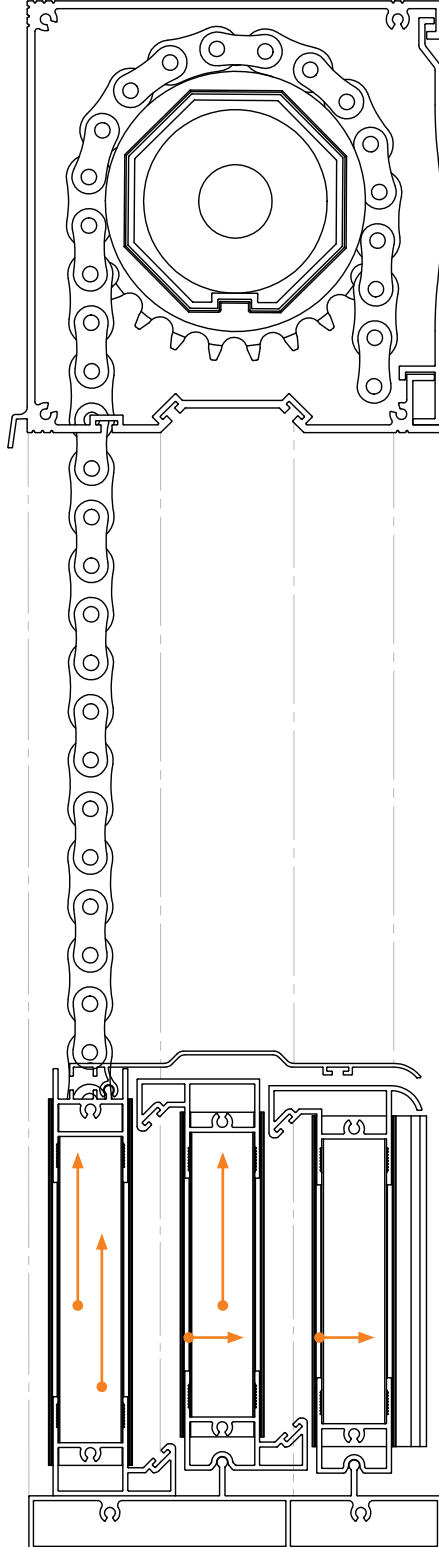

3. Kademe - Level 3

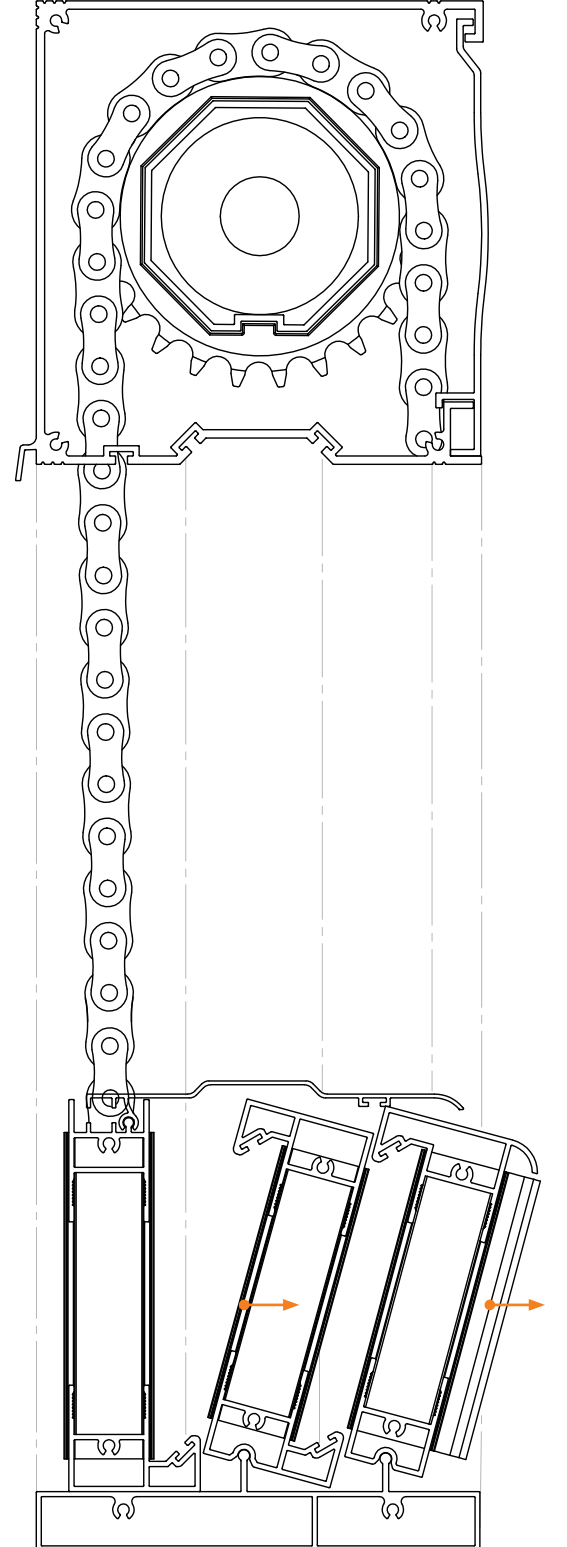

417

0,467 kg/m

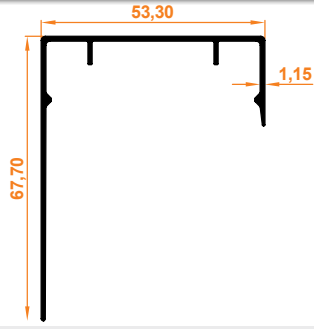

Sonlandırıcı Cam Çıta Kapak Profili
End Cap Glass Strip Cover Profile

Paket İçi Adet | 4
Quantity Per Package

418

0,329 kg/m

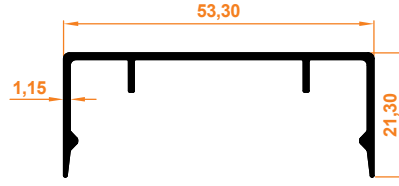

Cam Çıta Kapak Profili
Glass Strip Cover Profile

Paket İçi Adet | 10
Quantity Per Package

419

2,100 kg/m

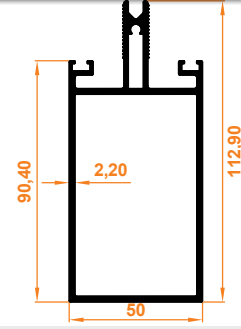

Orta Kayıt Profili
Center Mullion Profile

Paket İçi Adet | 2
Quantity Per Package

420

0,682 kg/m

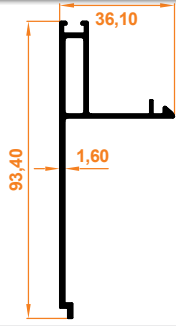

Kasa Kapatma Profili
Frame Closure Profile

Paket İçi Adet | 2
Quantity Per Package

421

3,184 kg/m

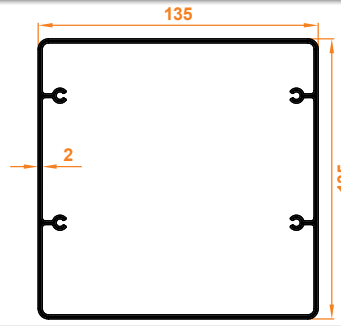

Ayak Profili
Leg Profile

Paket İçi Adet | 1
Quantity Per Package

422

4,318 kg/m

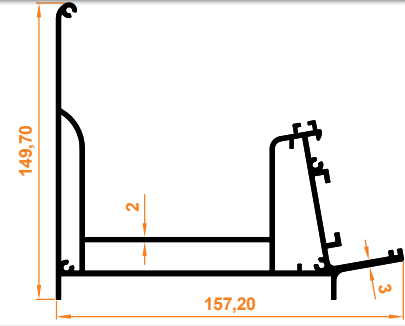

Oluk Profili
Groove Profile

Paket İçi Adet | 1
Quantity Per Package

423

3,142 kg/m

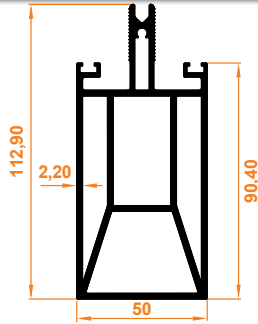

Destekli Orta Kayıt Profili
Reinforced Center Mullion Profile

Paket İçi Adet | 2
Quantity Per Package

424

2,835 kg/m

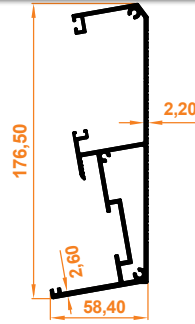

Duvar Kasa Profili
Wall Frame Profile

Paket İçi Adet | 1
Quantity Per Package

426

3,434 kg/m

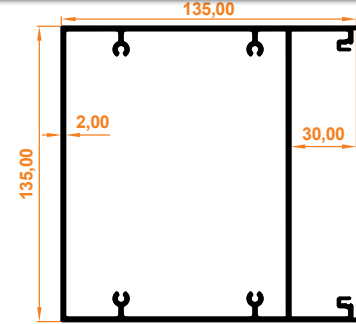

Gizli Ayak Profili
Hidden Leg Profile

Paket İçi Adet | 1
Quantity Per Package

427

2,271 kg/m

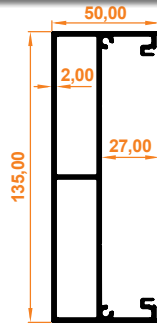

Destek Kutu Profili
Reinforcing Box Profile

Paket İçi Adet | 2
Quantity Per Package

428

0,501 kg/m

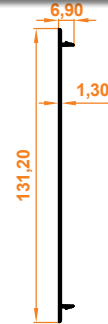

Gizli Ayak ve Destek Kutu Kapatma Profili
Hidden Leg Case Cover Support Profile

Paket İçi Adet | 10
Quantity Per Package

429

0,578 kg/m

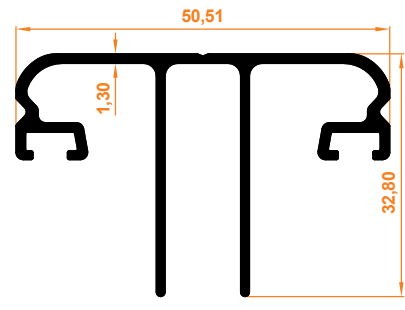

Cam Çıta Profili
Glass Strip Profile

Paket İçi Adet | 2
Quantity Per Package

430

2,252 kg/m

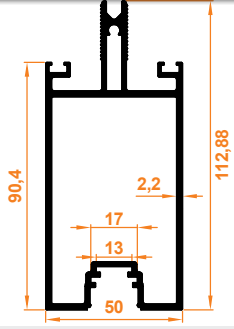

Ledli Orta Kayıt Profili
Center Mullion Profile with Led

Paket İçi Adet
Quantity Per Package

2

431

0,079 kg/m

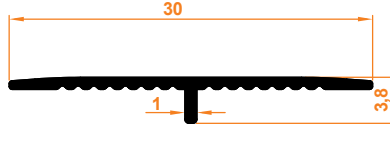

T Profili
T Profile

Paket İçi Adet
Quantity Per Package

10

7100

0,921 kg/m

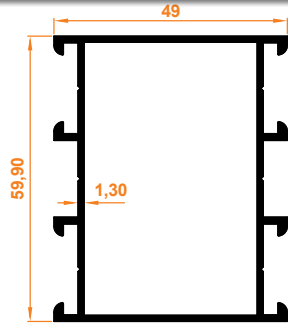

C60 Kasa Orta Kayıt Profili
C60 Case Mid Entry Profile

Paket İçi Adet
Quantity Per Package

4

7101

0,988 kg/m

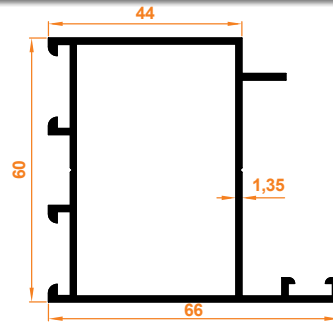

C60 Kanat Profili
C60 Wing Profile

Paket İçi Adet
Quantity Per Package

4

7102

1,440 kg/m

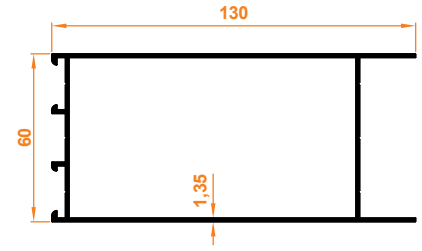

C60 Etek Profili
C60 Skirt Profile

Paket İçi Adet
Quantity Per Package

2

7103

1,099 kg/m

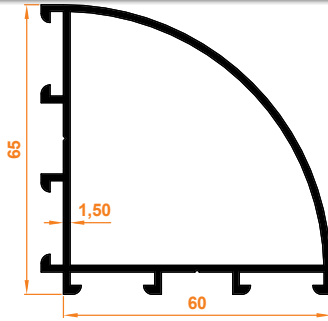

C60 Oval Köşe Dönüş Profili
C60 Oval Corner Profile

Paket İçi Adet
Quantity Per Package

2

7104

0,436 kg/m

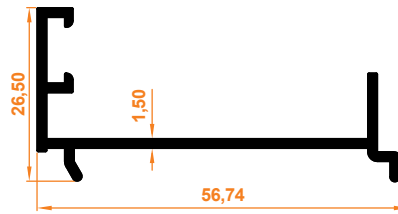

C60 Kanat Adaptörü Profili
C60 Wing Adapter Profile

Paket İçi Adet
Quantity Per Package

8

7105

1,155 kg/m

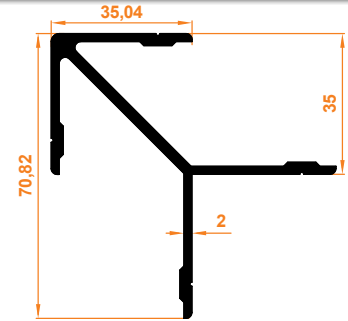

C60 Köşe Takozu
C60 Corner Wedge

Paket İçi Adet
Quantity Per Package

3

7106

0,467 kg/m

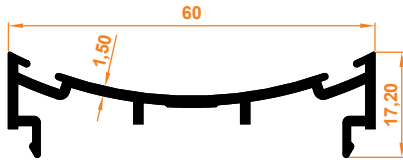

C60 Çarpma Kapı Adaptörü - Dişi
C60 Crash Door Adapter - Female

Paket İçi Adet
Quantity Per Package

8

7107

0,367 kg/m



C60 Çarpma Kapı Adaptörü - Erkek
C60 Crash Door Adapter - Male

Paket İçi Adet
Quantity Per Package

8

7108

0,241 kg/m

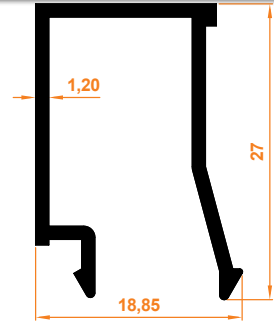

C60 Isıcam Çıta Profili
C60 Insulating Glass Stave Profile

Paket İçi Adet
Quantity Per Package

24

7109

0,234 kg/m

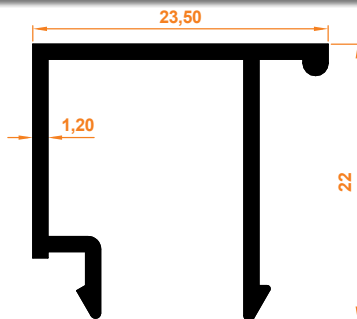

C60 Tek Cam Çıta Profili
C60 Single Glass Stave Profile

Paket İçi Adet
Quantity Per Package

24

ALDOKS SERİ ALÜMİNYUM PROFİL GRUBU

Aldoks Series Aluminum Profile Group

7000

0,473 kg/m

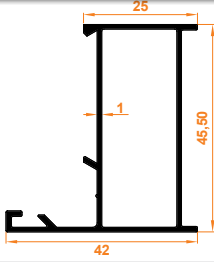

Aldoks (Dar) Kasa Profili
Aldoks (Tight) Frame Profile

Paket İçi Adet
Quantity Per Package

6

7003

0,891 kg/m

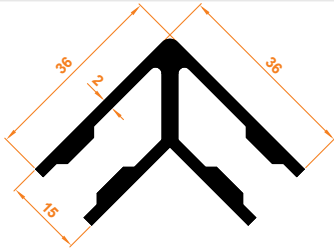

Aldoks (Dar) Köşe Takozu
Aldoks (Tight) Corner Wedge

Paket İçi Adet
Quantity Per Package

3

7006

0,659 kg/m

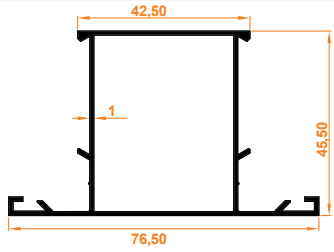

Aldoks (Orta) Kayıt Profili
Aldoks (Mid) Entry Profile

Paket İçi Adet
Quantity Per Package

3

7009

0,719 kg/m

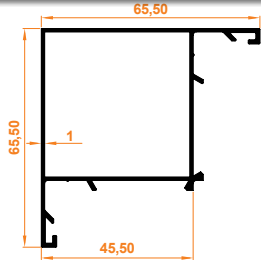

Aldoks Köşe Dönüş Profili
Aldoks Corner Profile

Paket İçi Adet
Quantity Per Package

2

7012

1,149 kg/m

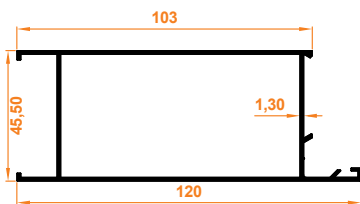

Aldoks Etek Profili
Aldoks Skirt Profile

Paket İçi Adet
Quantity Per Package

2

7001

0,565 kg/m

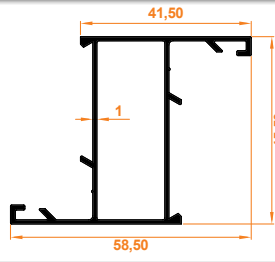

Aldoks (Dar) Kanat Profili
Aldoks (Tight) Wing Profile

Paket İçi Adet
Quantity Per Package

4

7004

0,565 kg/m

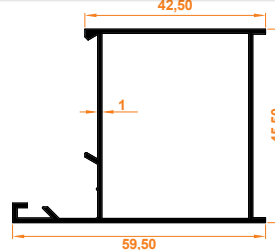

Aldoks (Orta) Kasa Profili
Aldoks (Mid) Frame Profile

Paket İçi Adet
Quantity Per Package

6

7007

1,136 kg/m

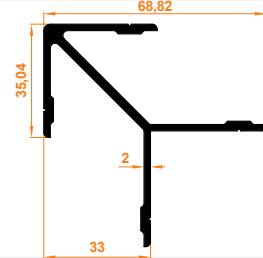

Aldoks (Orta) Köşe Takozu
Aldoks (Mid) Corner Wedge

Paket İçi Adet
Quantity Per Package

3

7010

1,028 kg/m

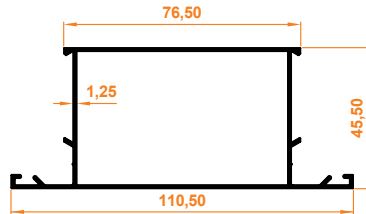

Aldoks (Geniş) Orta Kayıt Profili
Aldoks (Wide) Mid Entry Profile

Paket İçi Adet
Quantity Per Package

2

7013

0,215 kg/m

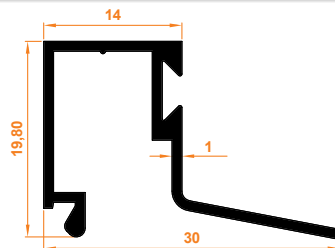

Aldoks Isıcam Çita
Aldoks Double Glazing Stave

Paket İçi Adet
Quantity Per Package

10

7002

0,565 kg/m

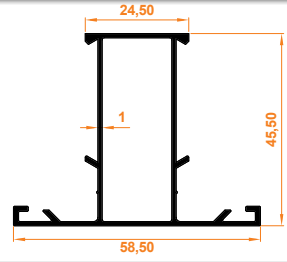

Aldoks (Dar) Orta Kayıt Profili
Aldoks (Tight) Mid Entry Profile

Paket İçi Adet
Quantity Per Package

4

7005

0,659 kg/m

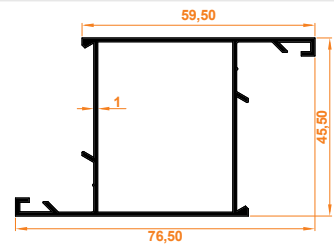

Aldoks (Orta) Kanat Profili
Aldoks (Mid) Wing Profile

Paket İçi Adet
Quantity Per Package

3

7008

0,695 kg/m

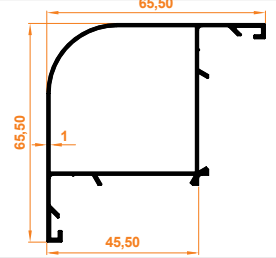

Aldoks Oval Köşe Dönüş Profili
Aldoks Oval Corner Profile

Paket İçi Adet
Quantity Per Package

2

7011

1,028 kg/m

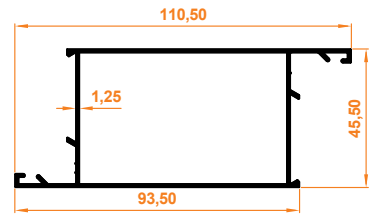

Aldoks (Geniş) Kanat Profili
Aldoks (Wide) Wing Profile

Paket İçi Adet
Quantity Per Package

2

7014

0,213 kg/m

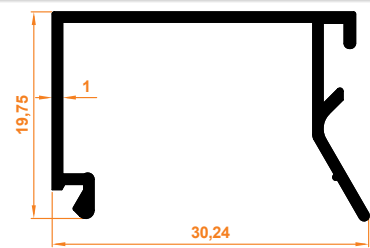

Aldoks Tek Cam Çita
Aldoks Single Glass Stave

Paket İçi Adet
Quantity Per Package

16

700

0,185 kg/m

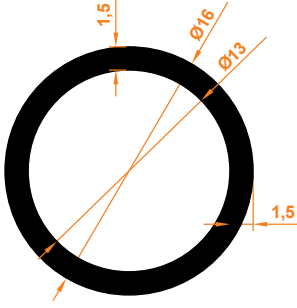

16x1,5 Boru

16x1,5 Pipe

Paket İçi Adet
Quantity Per Package

12

701

0,538 kg/m

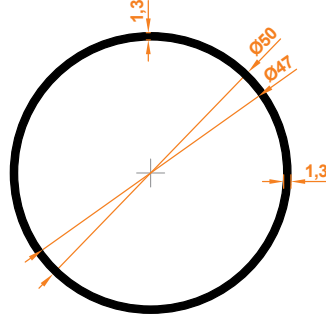

50x1,3 Boru

50x1,3 Pipe

Paket İçi Adet
Quantity Per Package

3

702

0,509 kg/m

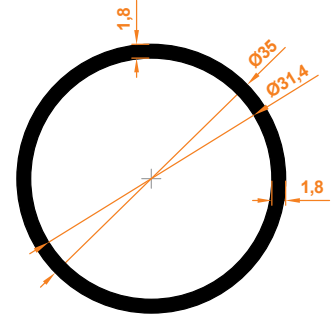

35x1,8 Boru

35x1,8 Pipe

Paket İçi Adet
Quantity Per Package

4

703

0,182 kg/m

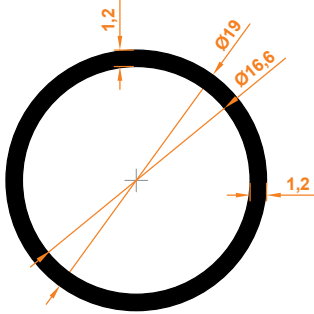

19x1,2 Boru

19x1,2 Pipe

Paket İçi Adet
Quantity Per Package

12

704

0,162 kg/m

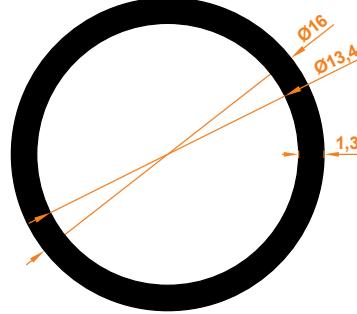

16x1,3 Boru

16x1,3 Pipe

Paket İçi Adet
Quantity Per Package

12

900

0,685 kg/m

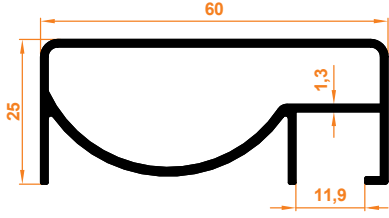

60x25 mm Üst Kúpeşte Yandan Kanallı
60x25 mm Upper Handrail with Side Channel

Paket İçi Adet
Quantity Per Package

4

901

0,230 kg/m

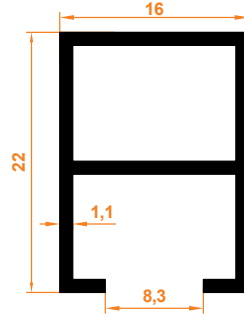

Cam Tutucu
Glass Holder

Paket İçi Adet
Quantity Per Package

10

902

0,848 kg/m

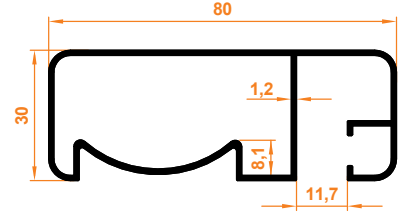

80x30 Yandan Kanallı
80x30 Side Channel

Paket İçi Adet
Quantity Per Package

4

903

0,785 kg/m

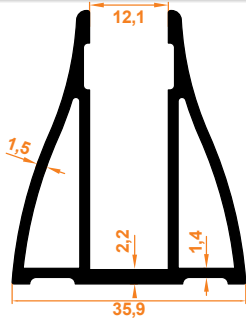

Cam Alt Baza
Glass Bottom Base

Paket İçi Adet
Quantity Per Package

3

904

0,159 kg/m

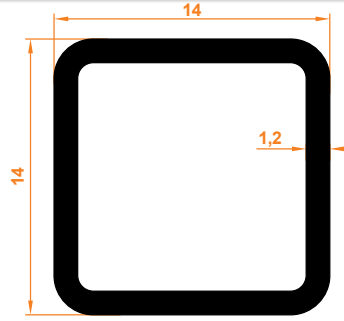

14x14 Emniyet Şeridi
14x14 Safety Strip

Paket İçi Adet
Quantity Per Package

20

905

0,060 kg/m

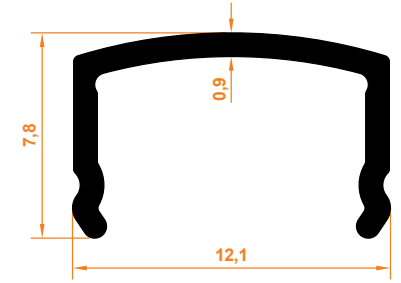

Boru Çıtası
Pipe Lath

Paket İçi Adet
Quantity Per Package

20

906

0,650 kg/m

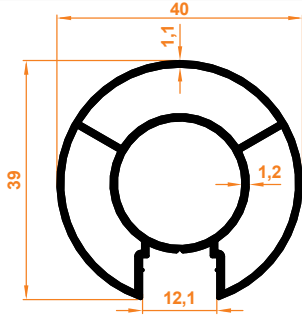

40x1,1 mm Tek Kanallı Çiftli Dikme
40x1,1 mm Single Channel Double Column

Paket İçi Adet
Quantity Per Package

4

907

0,532 kg/m

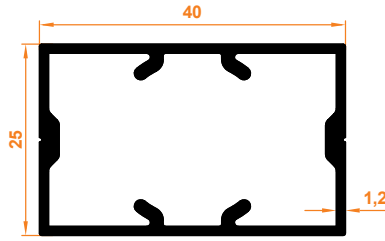

40x25 Dikme
40x25 Column

Paket İçi Adet
Quantity Per Package

10

908

0,922 kg/m

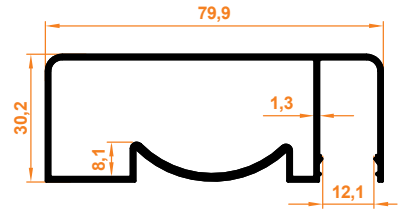

80x30 Yandan Kanallı
80x30 Side Channel

Paket İçi Adet
Quantity Per Package

4

909

0,717 kg/m

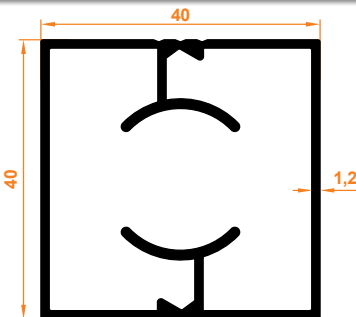

40x40 Kanalsız Dikme
40x40 Non Channel Column

Paket İçi Adet
Quantity Per Package

3

910

0,631 kg/m

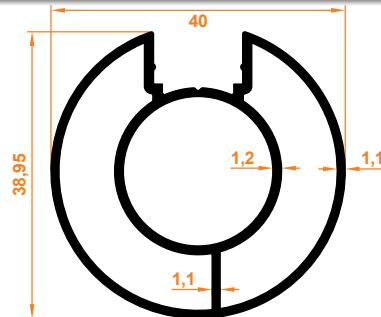

40x1,1 mm Tek Kanallı Tekli Dikme
40x1,1 mm Single Channel Single Column

Paket İçi Adet
Quantity Per Package

4

911

0,840 kg/m

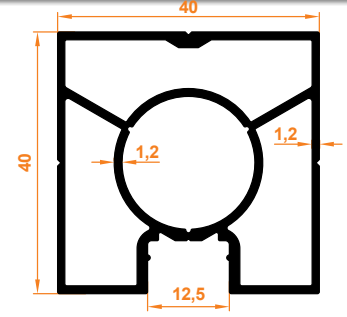

40x40 Tek Kanallı Dikme
40x40 Single Channel Column

Paket İçi Adet
Quantity Per Package

3

912

0,641 kg/m

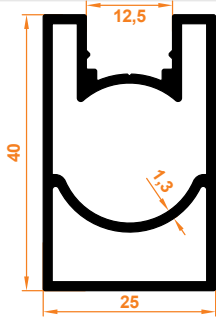

40x25 Tek Kanallı
40x25 Single Slot

Paket İçi Adet
Quantity Per Package

10

913

0,064 kg/m

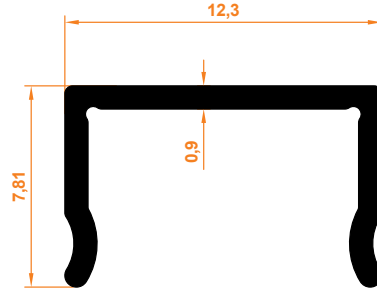

Kare Çıta
Square Slat

Paket İçi Adet
Quantity Per Package

20

914

0,082 kg/m

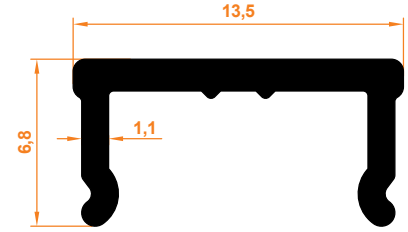

80x30 Yandan Kanallı Çıtası
80x30 Side Slot Rail

Paket İçi Adet
Quantity Per Package

20

915

0,778 kg/m

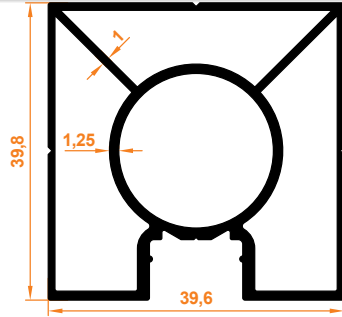

40x40 Tek Kanallı Dikme
40x40 Single Slot Column

Paket İçi Adet
Quantity Per Package

3

916

0,627 kg/m

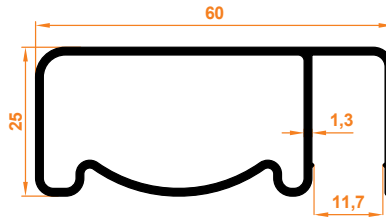

60x25 Yandan Kanallı
60x25 Side Slot

Paket İçi Adet
Quantity Per Package

4

918

0,256 kg/m

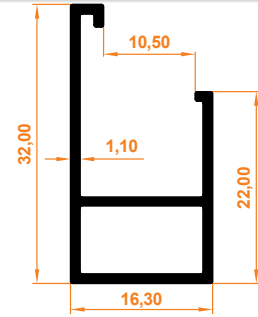

8-10 mm Cam Altı Profil
8-10 mm Glass Bottom

Paket İçi Adet
Quantity Per Package

10

919

0,807 kg/m

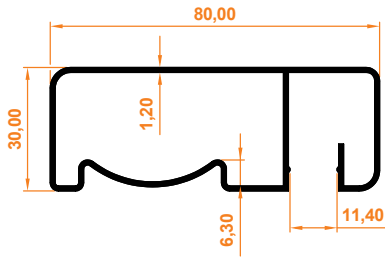

80x30 Yandan Kanallı
80x30 Side Slot

Paket İçi Adet
Quantity Per Package

4

923

0,326 kg/m

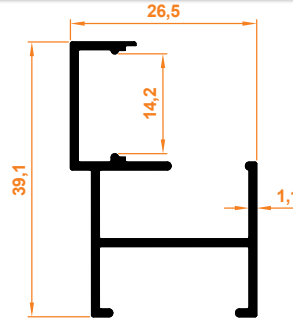

Cam Tutucu Profil
Glass Holder Profile

Paket İçi Adet
Quantity Per Package

10

924

0,082 kg/m

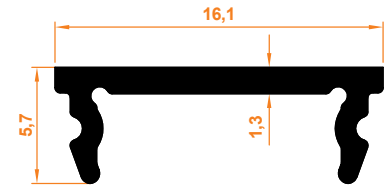

Takviyesiz Cam Tutucu Çıta Profil
Non-Reinforced Glass Holder Lath Profile

Paket İçi Adet
Quantity Per Package

20

925

0,396 kg/m

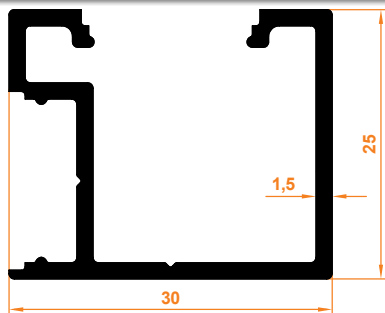

Takviyesiz Cam Tutucu Profil
Non-Reinforced Glass Holder Profile

Paket İçi Adet
Quantity Per Package

6

ZIP PERDE PROFİL GRUBU

Zip Blinds Profile Group

250

1,288 kg/m

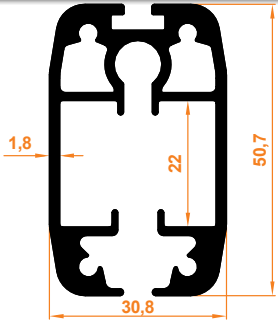

Kanat Profili
Wing Profile

Paket İçi Adet
Quantity Per Package

2

251

0,572 kg/m

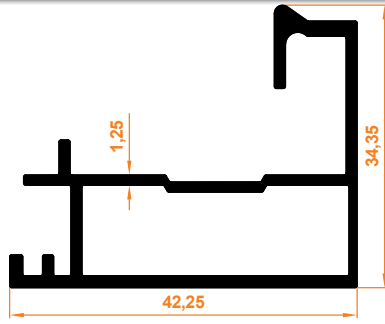

Yan Kasa Profili
Side Case Profile

Paket İçi Adet
Quantity Per Package

6

252

0,313 kg/m

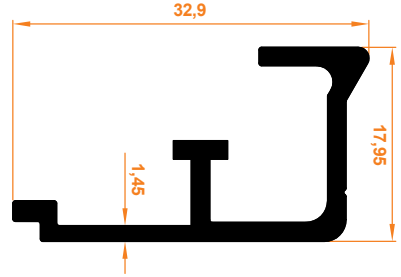

Yan Kasa Kapak Profili
Side Case Cover Profile

Paket İçi Adet
Quantity Per Package

10

7150

1,776 kg/m

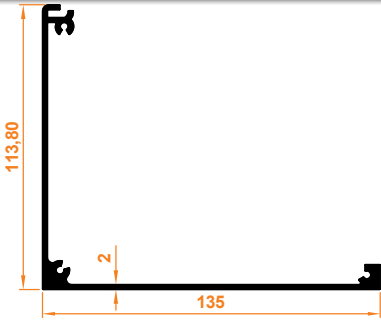

Üst Kasa Profili
Upper Case Profile

Paket İçi Adet
Quantity Per Package

2

7151

1,475 kg/m

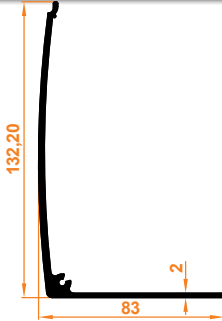

Üst Kasa Kapak Profili
Upper Case Cover Profile

Paket İçi Adet
Quantity Per Package

2

ZP 13

2,110 kg/m

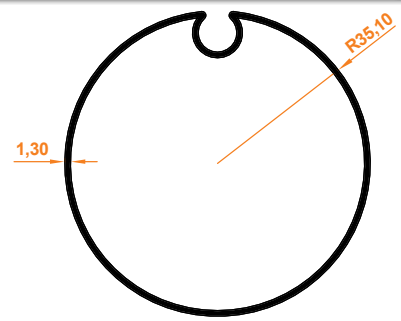

Sac Tambur Borusu
Sheet Drum Tube

Paket İçi Adet
Quantity Per Package

1

ZP 15

0,800 kg/m



5x20 Lama Demir
5x20 Blade Iron

Paket İçi Adet
Quantity Per Package

1

312

0,156 kg/m

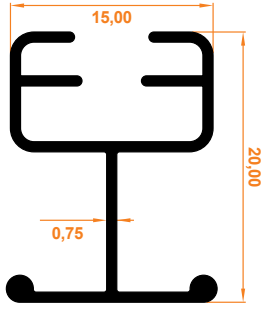

T Profil
T Profile

Paket İçi Adet
Quantity Per Package

10

334

0,265 kg/m

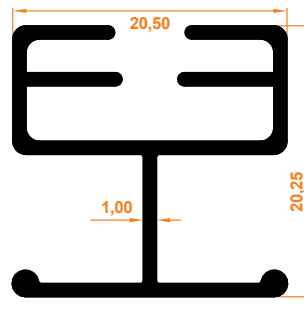

20'lik T Profil
20 T Profile

Paket İçi Adet
Quantity Per Package

10

339

0,102 kg/m

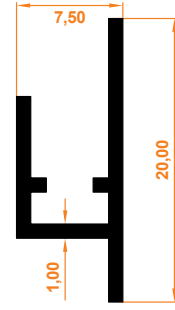

Yaylı Yapışkan Profil
Spring Adhesive Profile

Paket İçi Adet
Quantity Per Package

10

332

0,094 kg/m

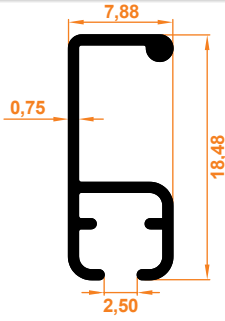

Small T Profil
Small T Profile

Paket İçi Adet
Quantity Per Package

10

340

0,076 kg/m

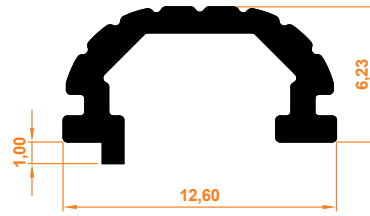

Yaylı Portray Profil
Spring Portray Profile

Paket İçi Adet
Quantity Per Package

10

327

0,252 kg/m

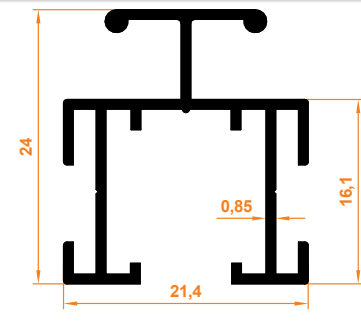

Çiftli Orta Profil
Double Middle Profile

Paket İçi Adet
Quantity Per Package

10

330

0,105 kg/m



Portray Yapışkan Profil
Adhesive Profile

Paket İçi Adet
Quantity Per Package

10

350

0,451 kg/m

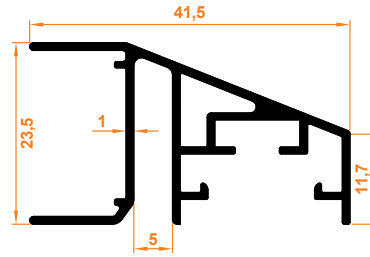

Plise Perde Kasa Profil
Pleated Curtain Case Profile

Paket İçi Adet
Quantity Per Package

6

357

0,162 kg/m

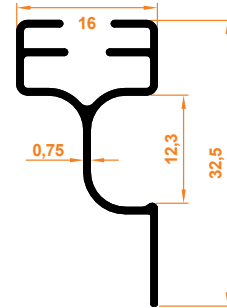

Etekli T Profil
Extended T Profile

Paket İçi Adet
Quantity Per Package

10

200

0,136 kg/m

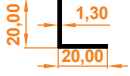

20x20 Köşebent
20x20 Angle Bracket

Paket İçi Adet | 15
Quantity Per Package

201

0,207 kg/m

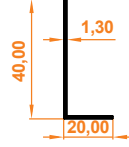

20x40 Köşebent
20x40 Angle Bracket

Paket İçi Adet | 15
Quantity Per Package

202

0,277 kg/m

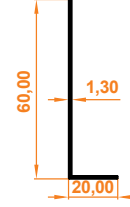

20x60 Köşebent
20x60 Angle Bracket

Paket İçi Adet | 10
Quantity Per Package

204

0,347 kg/m

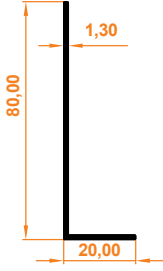

20x80 Köşebent
20x80 Angle Bracket

Paket İçi Adet | 10
Quantity Per Package

203

0,418 kg/m

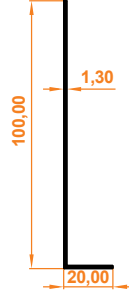

20x100 Köşebent
20x100 Angle Bracket

Paket İçi Adet | 4
Quantity Per Package

205

0,488 kg/m

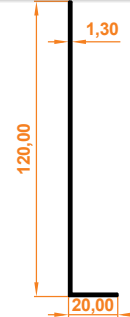

20x120 Köşebent
20x120 Angle Bracket

Paket İçi Adet | 4
Quantity Per Package

206

0,592 kg/m



20x150 Köşebent
20x150 Angle Bracket

Paket İçi Adet | 4
Quantity Per Package

404

0,384 kg/m

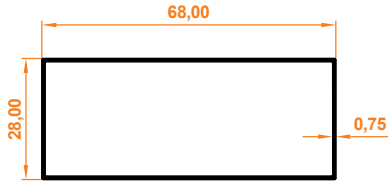

28x68 Kutu Profil
28x68 Box Profile

Paket İçi Adet | 34
Quantity Per Package

1044

0,960 kg/m

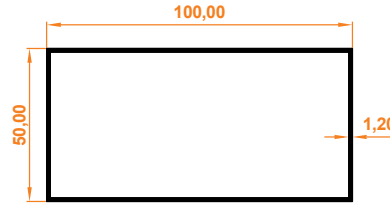

50x100 Kutu Profil
50x100 Box Profile

Paket İçi Adet | 4
Quantity Per Package

1102

0,531 kg/m

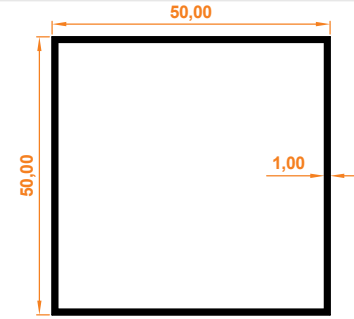

50x50 Kutu Profil
50x50 Box Profile

Paket İçi Adet | 3
Quantity Per Package

1400

0,426 kg/m

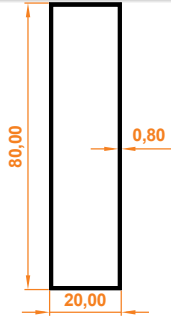

20x80 Kutu Profil
20x80 Box Profile

Paket İçi Adet | 4
Quantity Per Package

1402

0,917 kg/m

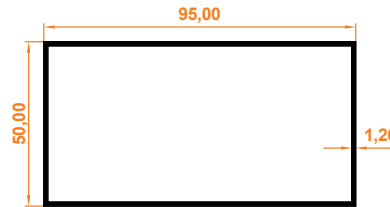

95x50 Kutu Profil
95x50 Box Profile

Paket İçi Adet | 3
Quantity Per Package

1403

0,505 kg/m

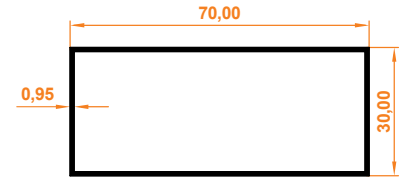

30x70 Kutu Profil
30x70 Box Profile

Paket İçi Adet | 5
Quantity Per Package

920

0,422 kg/m

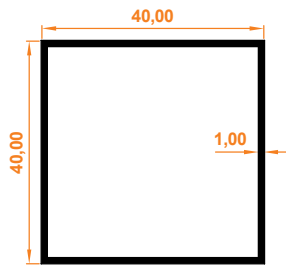

40x40 Kutu Profil
40x40 Box Profile

Paket İçi Adet | 6
Quantity Per Package

921

0,477 kg/m

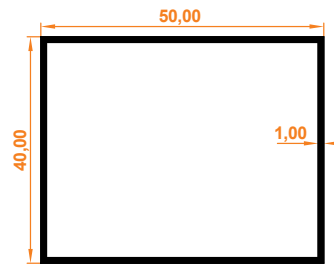

40x50 Kutu Profil
40x50 Box Profile

Paket İçi Adet | 8
Quantity Per Package

922

0,531 kg/m

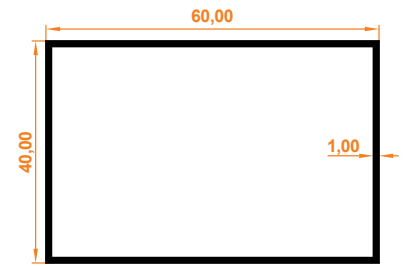

40x60 Kutu Profil
40x60 Box Profile

Paket İçi Adet | 8
Quantity Per Package

7180

0,576 kg/m

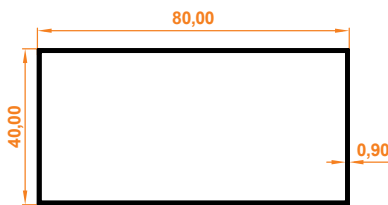

40x80 Kutu Profil
40x80 Box Profile

Paket İçi Adet | 4
Quantity Per Package

PANJUR PROFİL GRUBU

Shutter Profile Group

7

0,305 kg/m

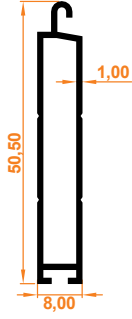

39x55 Alt Parça
39x55 Lower Part

Paket İçi Adet
Quantity Per Package

6

8

0,502 kg/m

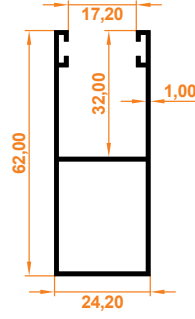

55'lik Yan Dikme
55 Side Column

Paket İçi Adet
Quantity Per Package

4

9

0,439 kg/m

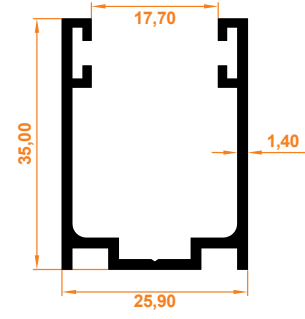

55'lik Kutusuz Dikme
55 Side Column Boxless

Paket İçi Adet
Quantity Per Package

6

1130

0,372 kg/m

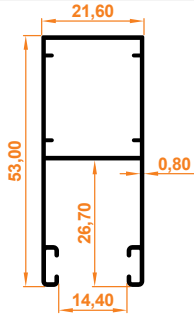

39'luk Yan Dikme
39 Side Column

Paket İçi Adet
Quantity Per Package

5

ÖZEL ÜRETİM PROFİL GRUBU

Special Production Profile Group

510

1,174 kg/m

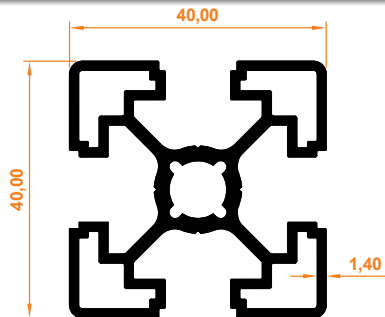

40x40 Sigma Profil
40x40 Sigma Profile

Paket İçi Adet
Quantity Per Package

3

1003

0,053 kg/m

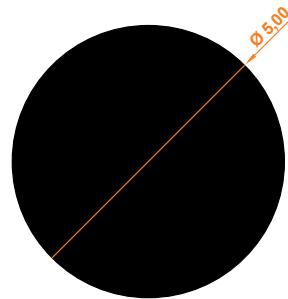

Q5 Dolu Mil
Q5 Solid Bar

Paket İçi Adet
Quantity Per Package

25

Process Alüminyum Plastik San. Tic. Ltd. Şti.

MERKEZ

Aşağıpınarbaşı OSB Mah. 524 Nolu Sk. No: 3/1 42250,
Selçuklu-Konya/TÜRKİYE

T : +90 332 248 00 92

F : +90 332 248 00 93

M : info@process.com.tr

MARMARA BÖLGE MÜDÜRLÜĞÜ

Cihangir Mh. Talatpaşa Cad. No:67
Avcılar/İSTANBUL - TÜRKİYE

T : +90 212 407 17 42

F : +90 212 407 15 42

M : marmara@process.com.tr

|| www.process.com.tr

|| www.processplise.com.tr

|| www.panjurmen.com.tr

|| www.demarco.com.tr

|| www.prosin.com.tr

