



2025



**Alüminyum Profil Kataloğu**  
Aluminium Profile Catalogue

# ALÜMİNYUM PROFİL GRUBU

Aluminium Profile Group

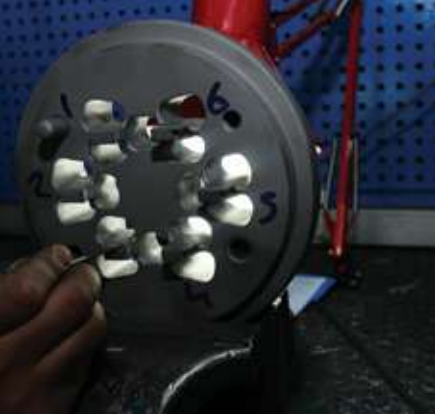

ISO 9001 | ISO 14001 | OHSAS 18001

## GOLD SERİ PLİSE SİNEKLİK / GOLD SERIES PLAİT FLY SCREEN

304

0,318 kg/m

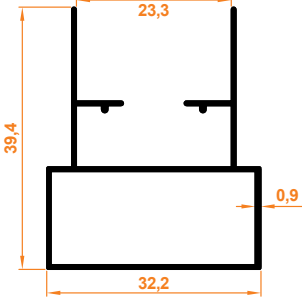

Gold Kasa Profil  
Gold Case Profile

305

0,330 kg/m

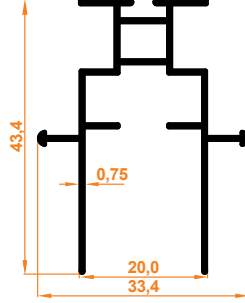

Gold Kanat Profil  
Gold Wing Profile

## STAR SERİ PLİSE SİNEKLİK / STAR SERIES PLAİT FLY SCREEN

302

0,272 kg/m

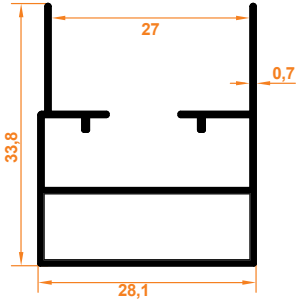

Star Kasa Profil  
Star Case Profile

301

0,303 kg/m

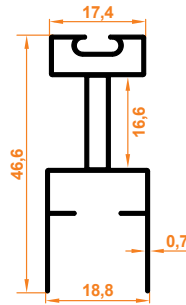

Star Kanat Profil  
Star Wing Profile

## JUNIOR SERİ PLİSE SİNEKLİK / JUNIOR SERIES PLAİT FLY SCREEN

306

0,243 kg/m

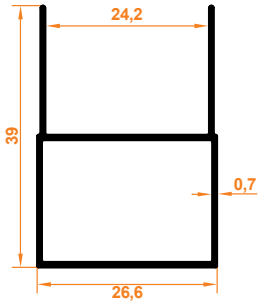

Junior Kasa Profil  
Junior Case Profile

307

0,304 kg/m

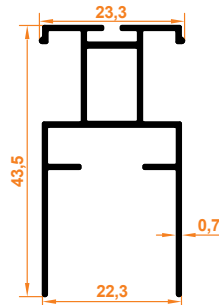

Junior Kanat Profil  
Junior Wing Profile

345

0,162 kg/m

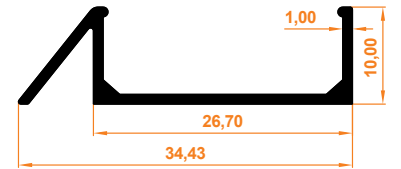

Junior Eşiksiz Kasa Profil  
Junior Case Profile without Threshold

**SLIM SERİ PLİSE SİNEKLİK / SLIM SERIES PLAİT FLY SCREEN**

**300** 0,218 kg/m

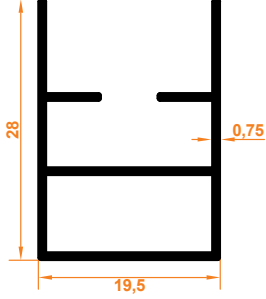

**Slim Kasa Profili**  
Slim Case Profile

**301** 0,303 kg/m

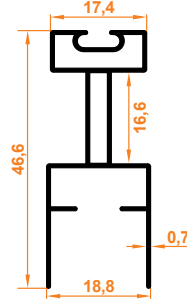

**Slim Kanat Profili**  
Slim Wing Profile

**331** 0,168 kg/m



**Slim Eşiksiz Profili**  
Slim Profile without Threshold

**NOBEL SERİ PLİSE SİNEKLİK / NOBEL SERIES PLAİT FLY SCREEN**

**335** 0,345 kg/m

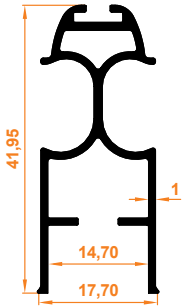

**Nobel Kanat Profili**  
Nobel Wing Profile

**336** 0,148 kg/m

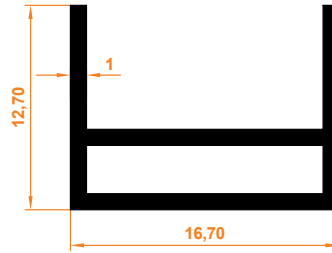

**Nobel Eşiksiz Kasa Profili**  
Nobel Case Profile without Threshold

**338** 0,250 kg/m

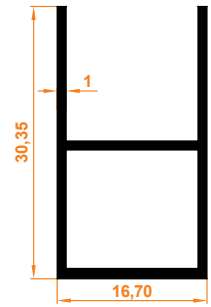

**Nobel Kasa Profili**  
Nobel Case Profile

**SÜPER SERİ PLİSE SİNEKLİK / SUPER SERIES PLAİT FLY SCREEN**

**316** 0,248 kg/m

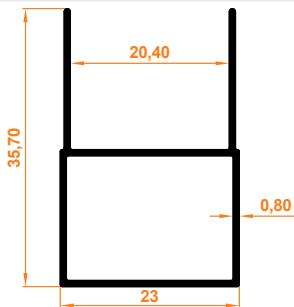

**Süper Seri Kasa Profili**  
Super Case Profile

**320** 0,303 kg/m

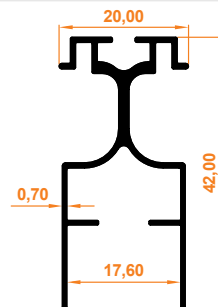

**Süper Seri Kanat Profili**  
Super Wing Profile

**325** 0,469 kg/m

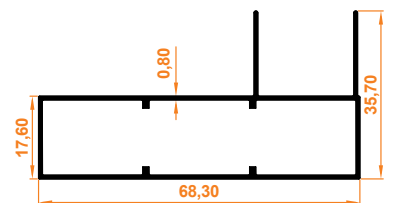

**Süper Büyük Kasa Profili**  
Super Big Case Profile

## NOBEL SERİ İÇTEN MONTAJLI PLİSE SİNEKLİK / NOBEL SERIES INTERNAL MOUNTED PLAIT FLY SCREEN

337

0,338 kg/m

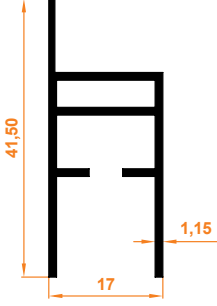

Nobel İçten Montajlı Kasa Profili  
Nobel Internal Mounted Case Profile

335

0,345 kg/m

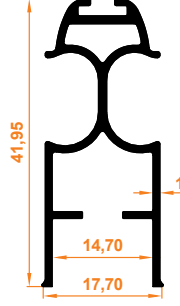

Nobel Kanat Profili  
Nobel Wing Profile

## SLIM SERİ İÇTEN MONTAJLI PLİSE SİNEKLİK / SLIM SERIES INTERNAL MOUNTED PLAIT FLY SCREEN

317

0,272 kg/m

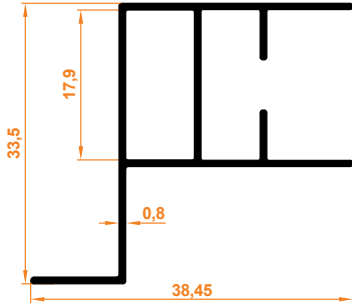

Kasa Profil  
Case Profile

301

0,303 kg/m

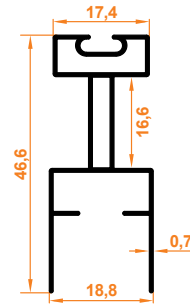

Kanat Profil  
Wing Profile

## İÇTEN MONTAJLI SABİT SİNEKLİK / INTERNAL MOUNTED FIXED FLY SCREEN

405

0,256 kg/m

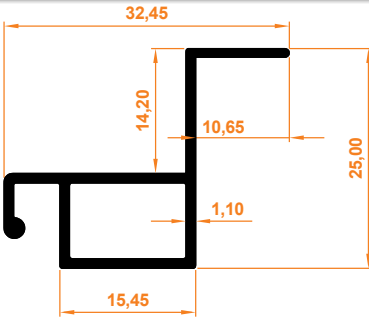

Kasa Profili  
Case Profile

**AYKİM SERİ SİNEKLİK / AYKİM SERIES FLY SCREEN**

**309** 0,374 kg/m

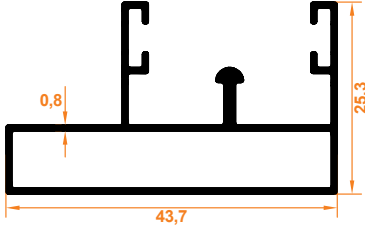

**Aykim Kasa Profil**  
Aykim Case Profile

**310** 0,315 kg/m

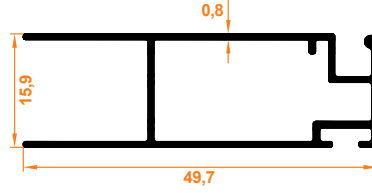

**Aykim Hareketli Profil**  
Aykim Sliding Profile

**PLATİN SERİ SİNEKLİK / PLATİN SERIES FLY SCREEN**

**321** 0,352 kg/m

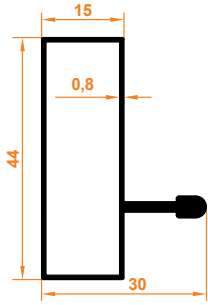

**Platin Tekli Kasa Profil**  
Platin Single Case Profile

**322** 0,455 kg/m

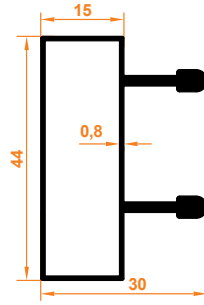

**Platin Çiftli Kasa Profil**  
Platin Double Case Profile

**323** 0,506 kg/m

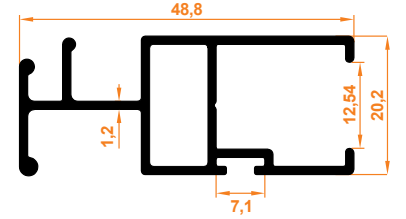

**Platin Kanat Profil**  
Platin Wing Profile

**DÜZ SİNEKLİK PROFİL GRUBU**  
Flat Fly Screen Profile Group

**400** 0,105 kg/m

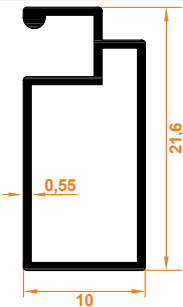

**10x20 Sineklik**  
10x20 Fly Screen

**401** 0,142 kg/m

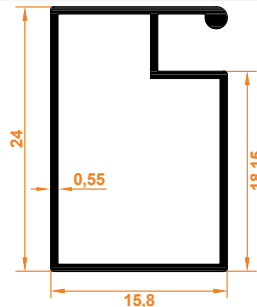

**17x25 Sineklik**  
17x25 Fly Screen

**402** 0,250 kg/m

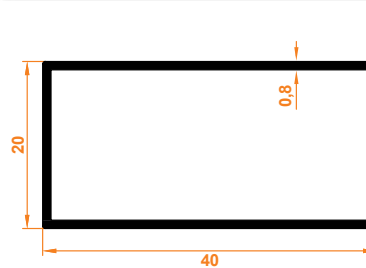

**20x40 Sineklik**  
20x40 Fly Screen

**311** 0,304 kg/m

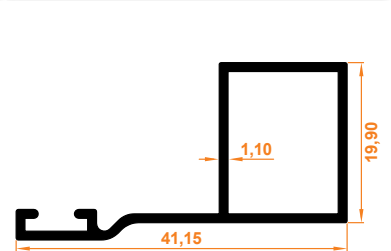

**İçe Açılır Fitilli Sineklik Profili**  
Inward Foldable Flyscreen Profile

# STOR SİNEKLİK PROFİL GRUBU

Stor Fly Screen Profile Group

407

0,342 kg/m

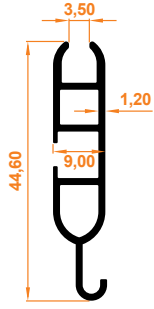

Stor Kanat Profil  
Stor Wing Profile

408

0,286 kg/m

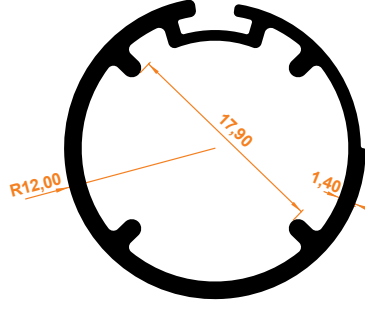

Stor Boru Profil  
Stor Pipe Profile

409

0,526 kg/m

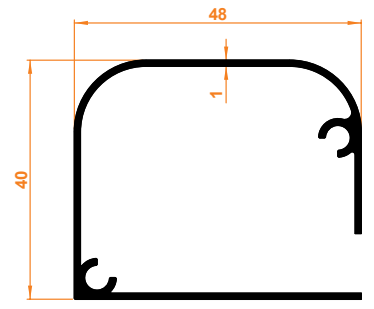

Stor Kasa Profil  
Stor Case Profile

410

0,413 kg/m

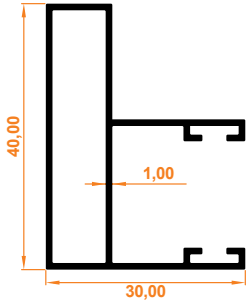

Stor Yan Kasa Profil  
Stor Side Case Profile

411

0,318 kg/m

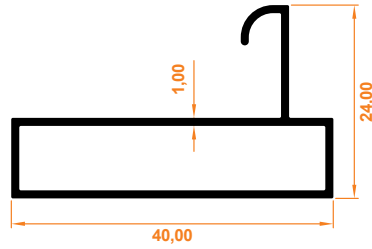

Stor Alt Kasa Profil  
Stor Bottom Case Profile

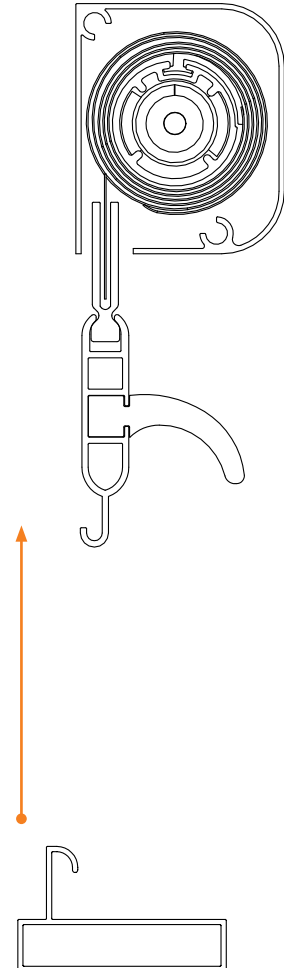
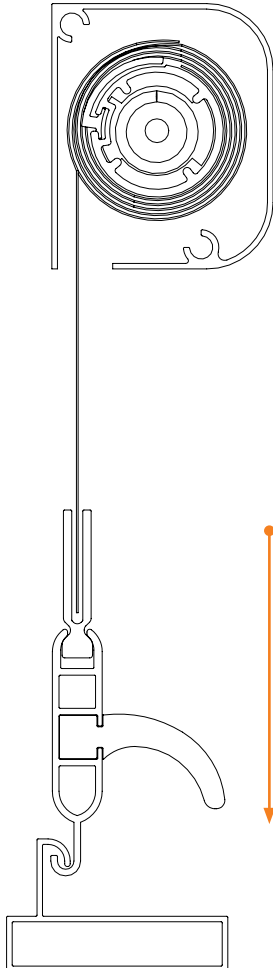

1

0,247 kg/m

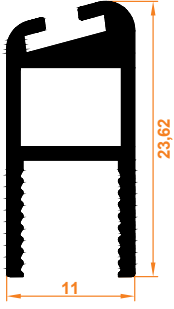

**Büyük D Fitol**  
Big D Wick

2

0,167 kg/m

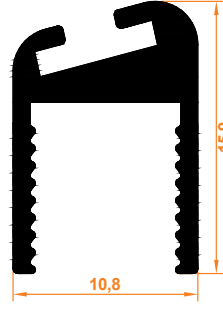

**Küçük D Fitol**  
Small D Wick

3

0,116 kg/m

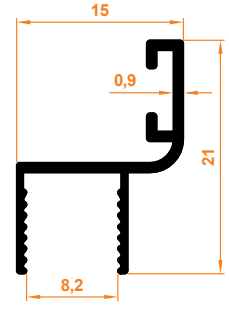

**Küçük h Fitol**  
Small h Wick

4

0,150 kg/m

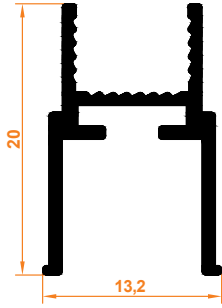

**Orta H Fitol**  
Middle H Wick

5

0,214 kg/m

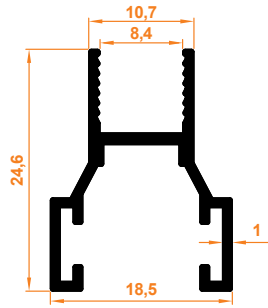

**Büyük H Fitol**  
Big H Wick

6

0,276 kg/m

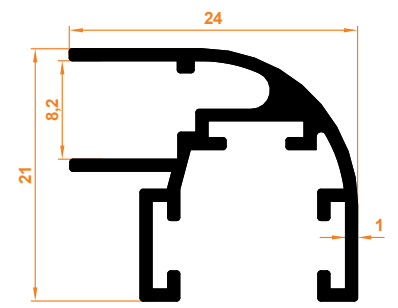

**Köşe Dönüş Fitol**  
Corner Return Wick



# 8 mm CAM BALKON PROFİL GRUBU

8 mm Glass Balcony Profile Group

101

0,078 kg/m

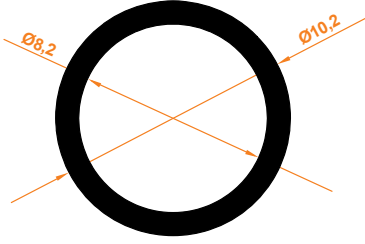

**10'lu Stoplama**  
10 Stopping Profile

104

0,717 kg/m

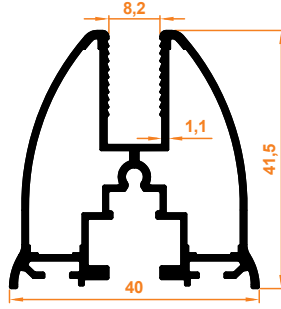

**Gold Baza Profil**  
Gold Base Profile

105

0,730 kg/m

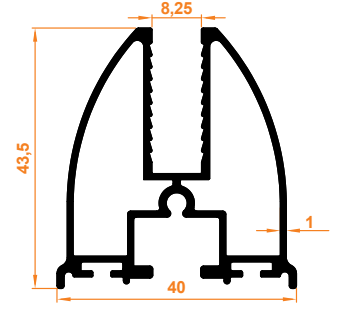

**Firtina Baza Profil**  
Firtina Base Profile

109

1,355 kg/m

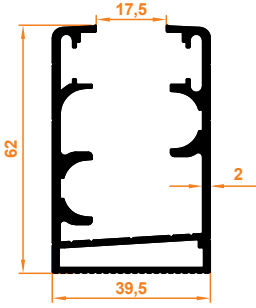

**Düz Kasa Profil**  
Flat Case Profile

110

1,396 kg/m

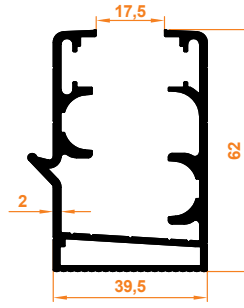

**Oluklu Kasa Profil**  
Corrugated Case Profile

100

0,441 kg/m

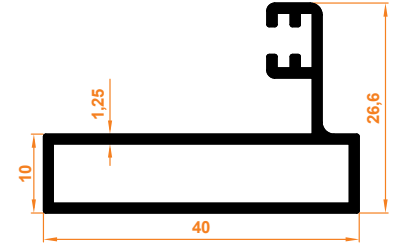

**Dar Yan Dikme**  
Thin Side Column

106

1,611 kg/m

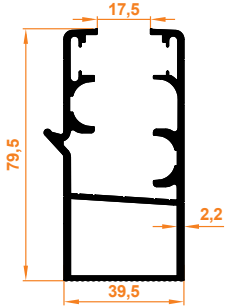

**Oluklu Büyük Kasa Profil**  
Corrugated Big Case Profile

107

1,570 kg/m

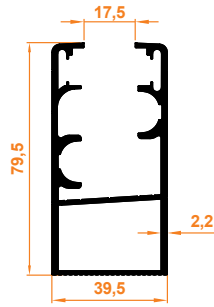

**Büyük Düz Kasa Profil**  
Big Flat Case Profile

108

0,457 kg/m

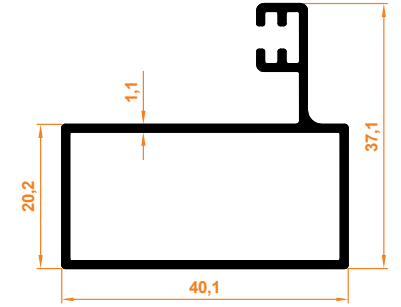

**Geniş Yan Dikme**  
Thick Side Column Profile

111

1,062 kg/m

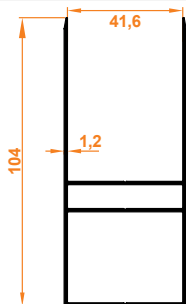

**Stor Profil**  
Stor Profile

135

0,517 kg/m

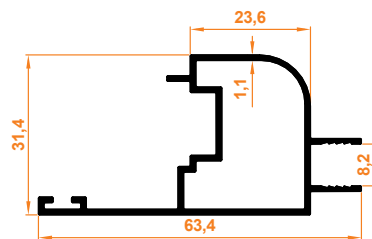

**8 mm İspanyolet Profil**  
8 mm Espagnolette Profile

136

0,343 kg/m

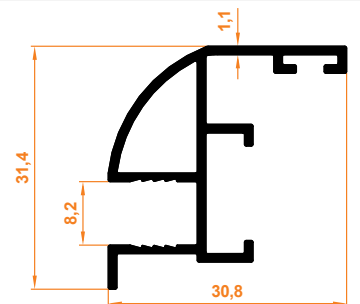

**8 mm İspanyolet Profil Karşılığı**  
8 mm Espagnolette Combination Profile

800

0,618 kg/m

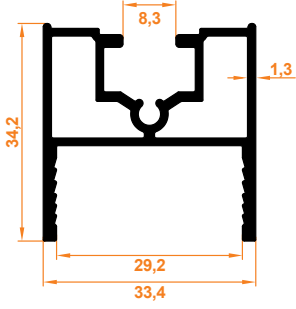

**Baza Profil**  
Base Profile

801

0,321 kg/m

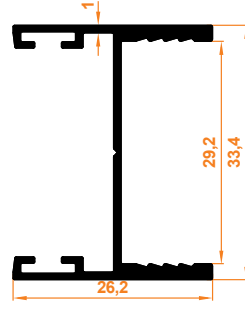

**Düz Kapak Profil**  
Flat Cover Profile

802

0,327 kg/m

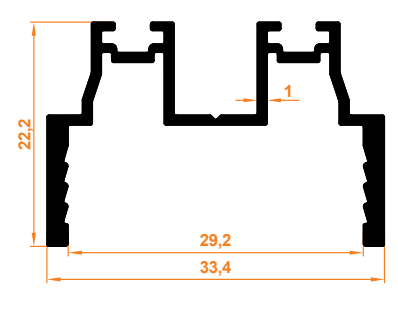

**Düz Kapak Mentеше Profil**  
Flat Cover with Hinge Profile

803

0,445 kg/m

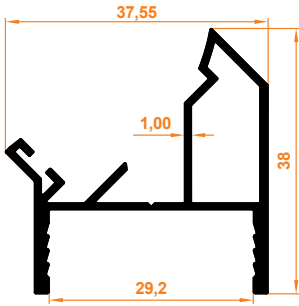

**45° Dönüş Profil**  
45° Return Profile

804

0,378 kg/m

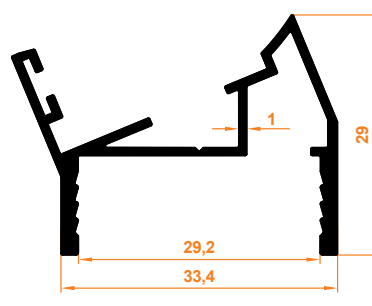

**22,5° Dönüş Profil**  
22,5° Return Profile

805

0,366 kg/m

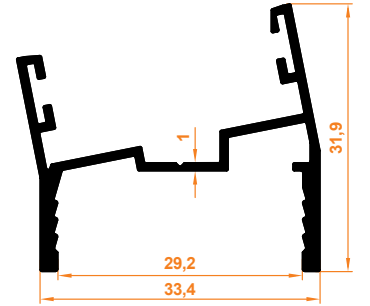

**11° Dönüş Profil**  
11° Return Profile

806

0,475 kg/m

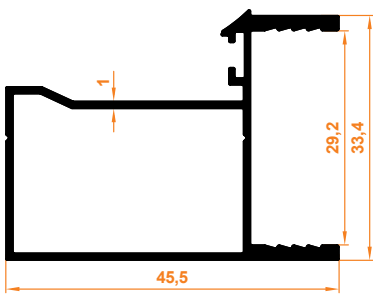

**90° Dönüş Profil**  
90° Return Profile

807

0,346 kg/m

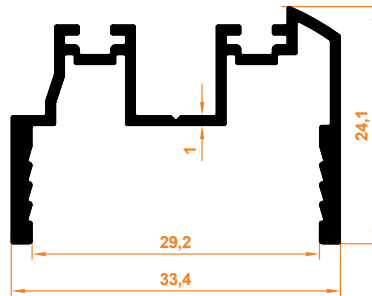

**Açılı Dönüş Mentеше Profil**  
PopUp Return Hinge Profile

808

0,369 kg/m

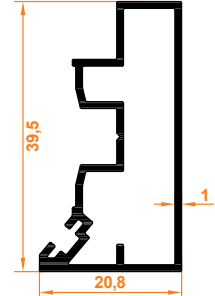

**Yan Dikme Profil**  
Side Column Profile

809

0,328 kg/m

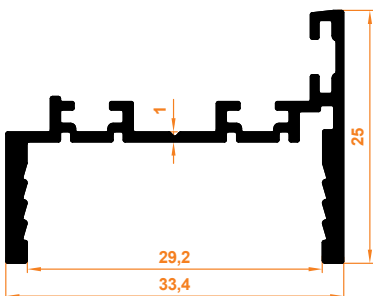

**Sabit Cam Mentеше Profil**  
Stable Glass Hinge Profile

810

0,355 kg/m

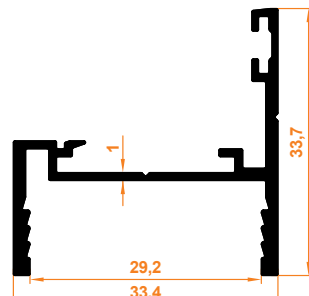

**Sabit Cam Kilit Profil**  
Stable Glass Lock Profile

811

0,342 kg/m

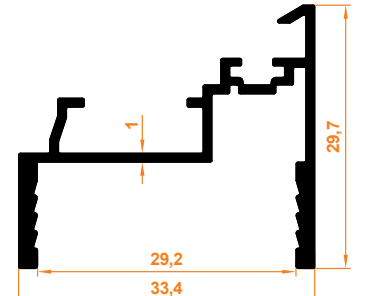

**Sabit Cam Kilit Karşılığı Profil**  
Stable Glass Lock Prevention Profile

819

1,344 kg/m

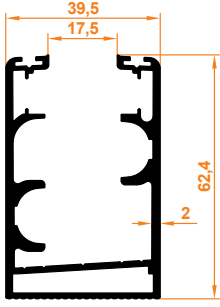

**Düz Kasa Üstten Fitilli Profil**  
Flat Case Top Wicked Profile

820

1,389 kg/m

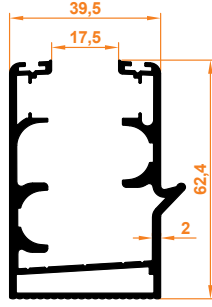

**Oluklu Kasa Üstten Fitilli Profil**  
Corrugated Case Top Wicked Profile

822

0,378 kg/m

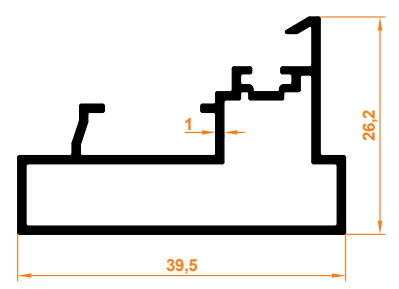

**Açılır Dikme Profil**  
PopUp Column Profile

816

1,577 kg/m

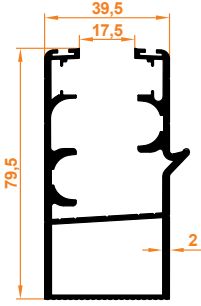

**Üstten Fitilli Büyük Oluklu Kasa**  
Large Corrugated Case with Top Wick

817

1,532 kg/m

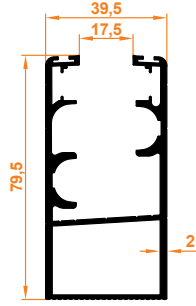

**Üstten Fitilli Büyük Düz Kasa**  
Large Flat Case with Wed from Top

815

0,100 kg/m

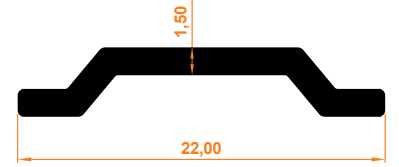

**Tij Profil**  
Espagnolette Profile

823

0,459 kg/m

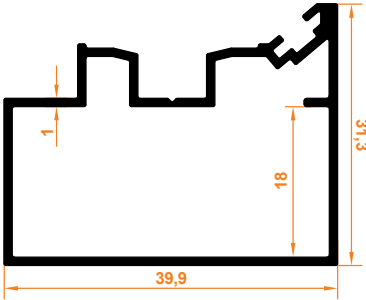

**Geniş Yan Dikme**  
Wide Side Column

824

0,583 kg/m

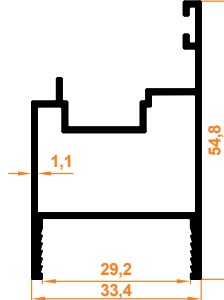

**Sabit Cam İspanyolet Profil**  
Fixed Glass Espagnolette Profile

825

0,356 kg/m

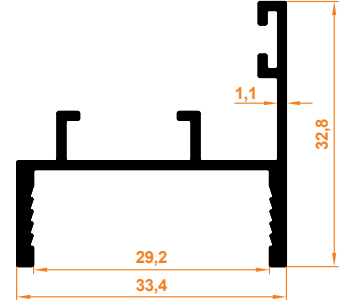

**Sabit Cam İspanyolet Karşılık Profil**  
Fixed Glass Espagnolette Handle Provision Profile

829

0,677 kg/m

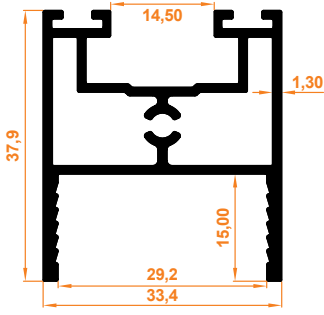

**Fıllı Baza Profil**  
Wicked Base Profile

801

0,321 kg/m

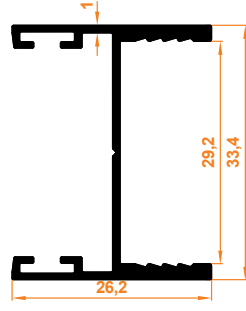

**Düz Kapak Profil**  
Flat Cover Profile

802

0,327 kg/m

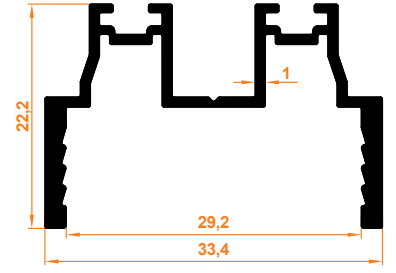

**Düz Kapak Mentşe Profil**  
Flat Cover with Hinge Profile

803

0,445 kg/m

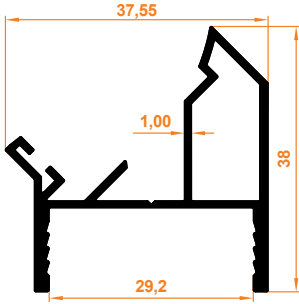

**45° Dönüş Profil**  
45° Return Profile

804

0,378 kg/m

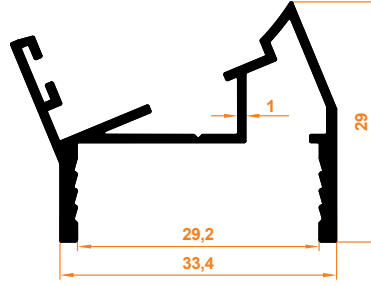

**22,5° Dönüş Profil**  
22,5° Return Profile

805

0,366 kg/m

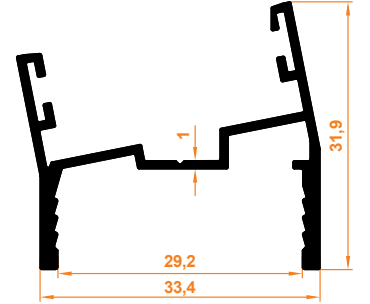

**11° Dönüş Profil**  
11° Return Profile

806

0,475 kg/m

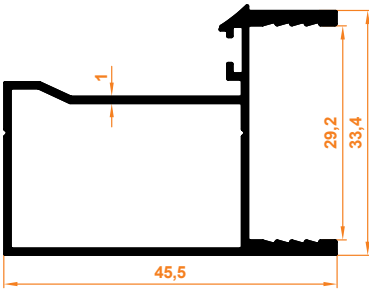

**90° Dönüş Profil**  
90° Return Profile

807

0,346 kg/m

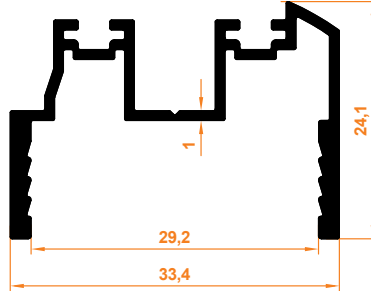

**Açılı Dönüş Mentşe Profil**  
PopUp Return Hinge Profile

808

0,369 kg/m

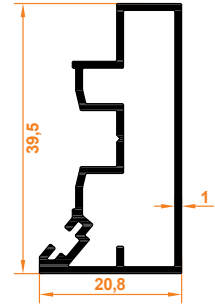

**Yan Dikme Profil**  
Side Column Profile

809

0,328 kg/m

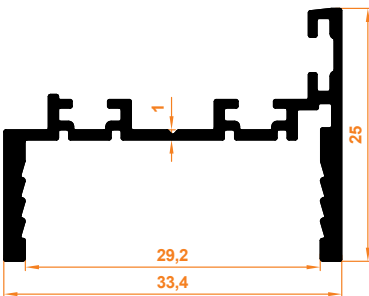

**Sabit Cam Mentşe Profil**  
Stable Glass Hinge Profile

810

0,355 kg/m

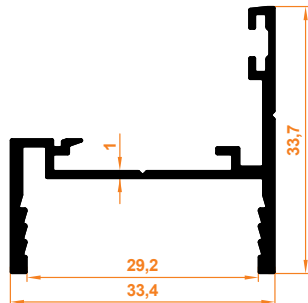

**Sabit Cam Kilit Profil**  
Stable Glass Lock Profile

811

0,342 kg/m

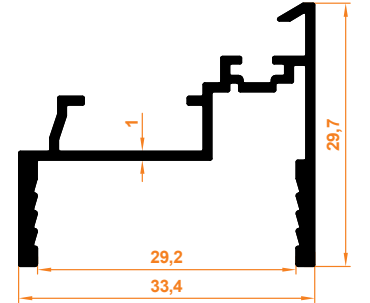

**Sabit Cam Kilit Karşılığı Profil**  
Stable Glass Lock Prevention Profile

109

1,355 kg/m

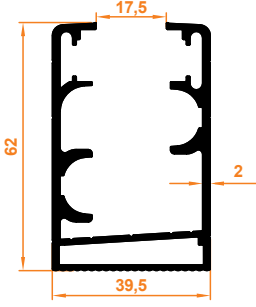

Düz Kasa Profil  
Flat Case Profile

110

1,396 kg/m

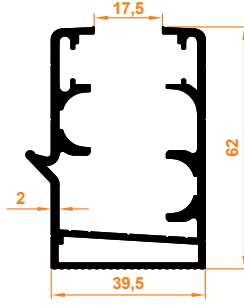

Oluklu Kasa Profil  
Corrugated Case Profile

822

0,378 kg/m

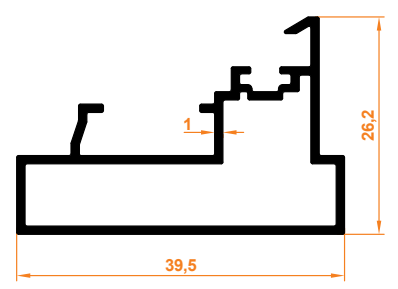

Açılır Dikme Profil  
PopUp Column Profile

106

1,611 kg/m

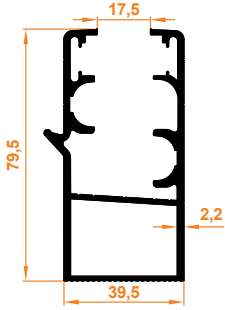

Oluklu Büyük Kasa Profil  
Corrugated Big Case Profile

107

1,570 kg/m

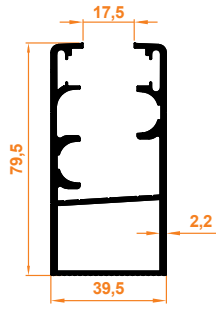

Büyük Düz Kasa Profil  
Big Flat Case Profile

815

0,100 kg/m

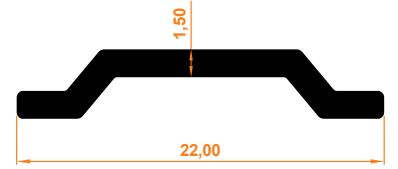

Tij Profil  
Espagnolette Profile

823

0,459 kg/m

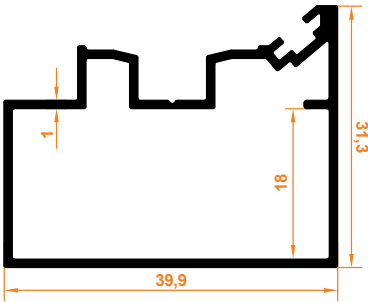

Geniş Yan Dikme  
Wide Side Column

824

0,583 kg/m

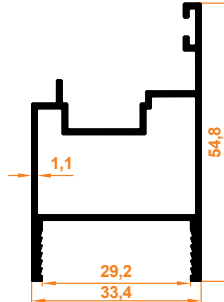

Sabit Cam İspanyolet Profil  
Fixed Glass Espagnolette Profile

825

0,356 kg/m

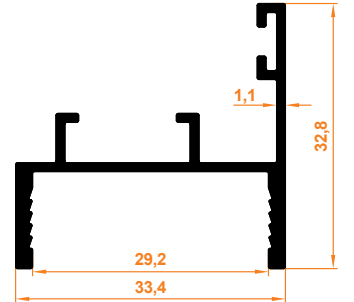

Sabit Cam İspanyolet Karşılık Profil  
Fixed Glass Espagnolette Handle Provision Profile

210

0,643 kg/m

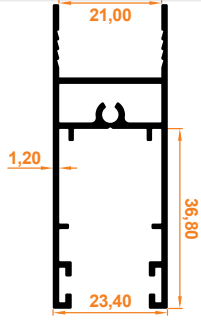

Sürme Baza Profil  
Sliding Base Profile

215

0,908 kg/m

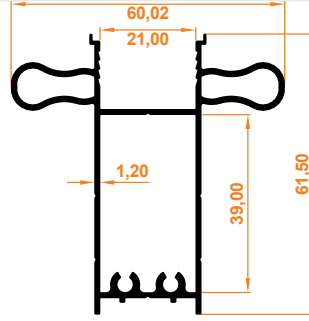

Çekme Kol Profil  
Pull Handle Profile

212

0,423 kg/m

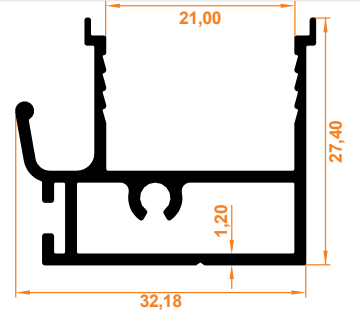

Kenet Profil  
Clamp Profile

211

0,301 kg/m

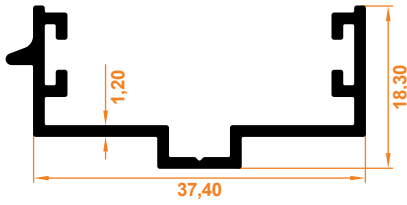

Birleştirme Karşılık Profil  
Combination Provisions Profile

213

0,974 kg/m

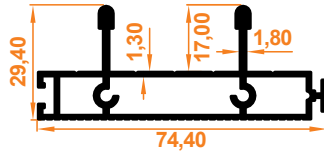

İkili Eşikli Alt Kasa Profil  
Double Threshold Lower Case Profile

222

1,333 kg/m

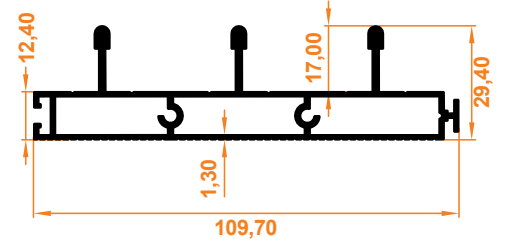

Üçlü Eşikli Alt Kasa Profil  
Triple Threshold Lower Case Profile

220

0,867 kg/m

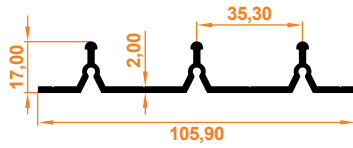

Üçlü Eşiksiz Alt Kasa Profil  
Triple Bottom Case Profile without Threshold

229

1,120 kg/m

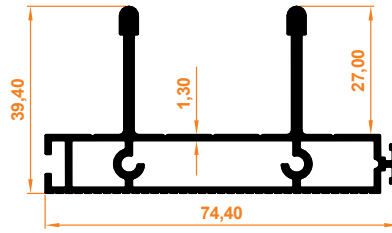

İkili Üst Kasa Profil  
Double Upper Case Profile

230

1,552 kg/m

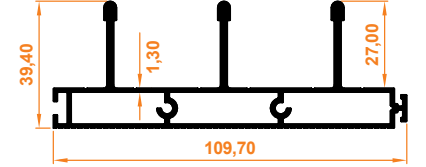

İkili Üçlü Kasa Profil  
Triple Upper Case Profile

221

1,156 kg/m

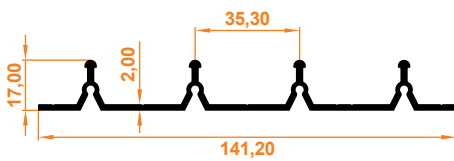

Dörtlü Eşiksiz Alt Kasa Profil  
Quadruple Bottom Case Profile without Threshold

214

0,587 kg/m

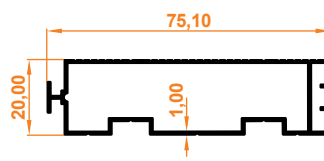

İkili Yan Kasa Profil  
Double Side Case Profile

223

0,792 kg/m

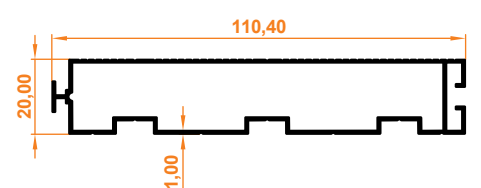

Üçlü Yan Kasa Profil  
Triple Side Case Profile

219

0,219 kg/m

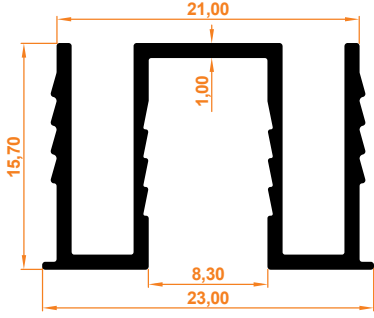

8 mm Cam Adaptörü  
8mm Glass Adapter

226

0,071 kg/m

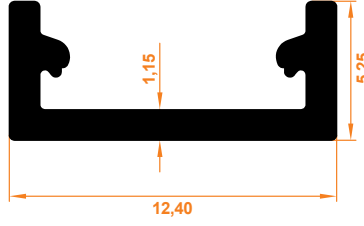

Kapatma Profil  
Closing Profile

227

0,894 kg/m

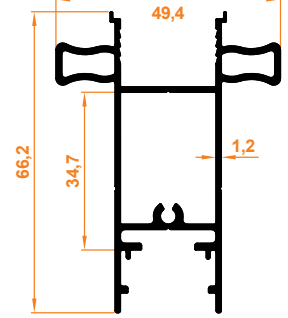

İspanyolet Çekme Koll Profili  
Espagnolette Pull Handle Profile

228

0,156 kg/m

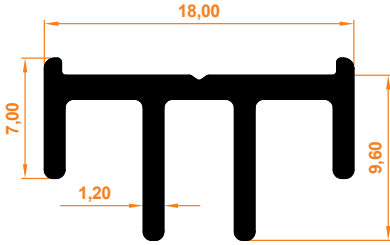

İspanyolet Karşılık Profili  
Espagnolette Provision Profile

## Sürme Sistem Çalışma Mekanizması

Sliding System Operating Mechanism

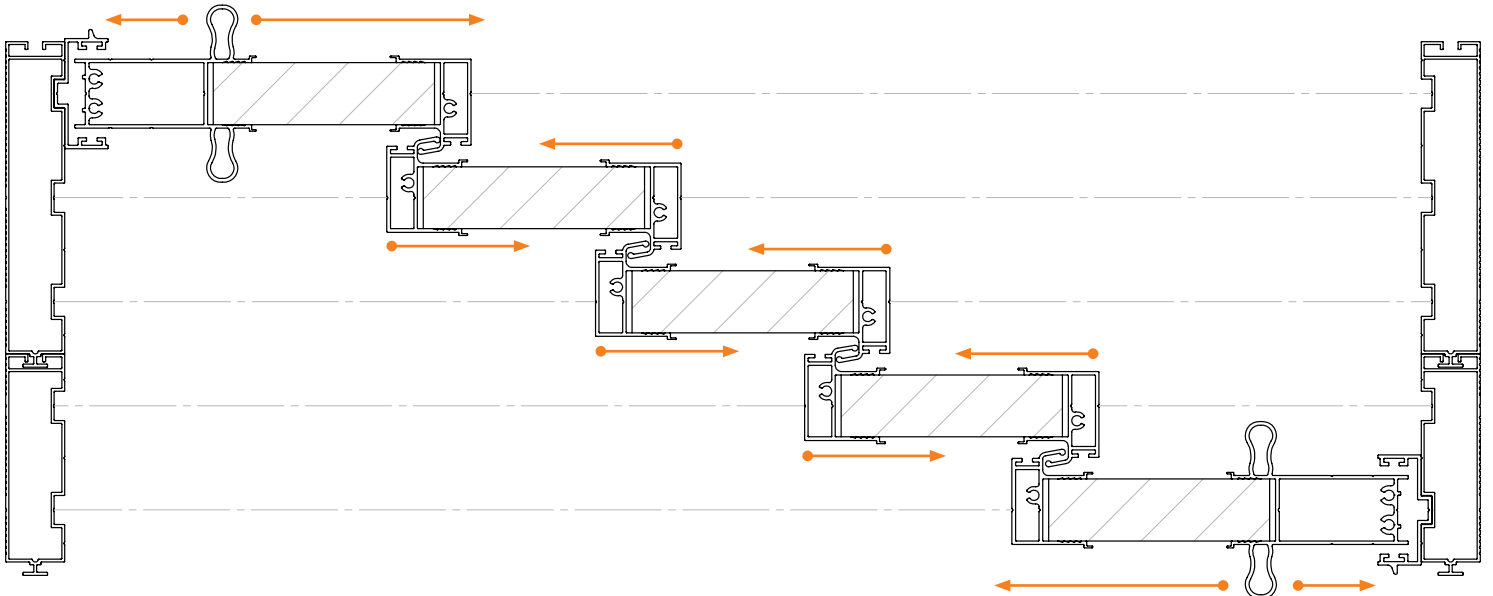

## Sürme Sistem Çalışma Mekanizması

Sliding System Operating Mechanism

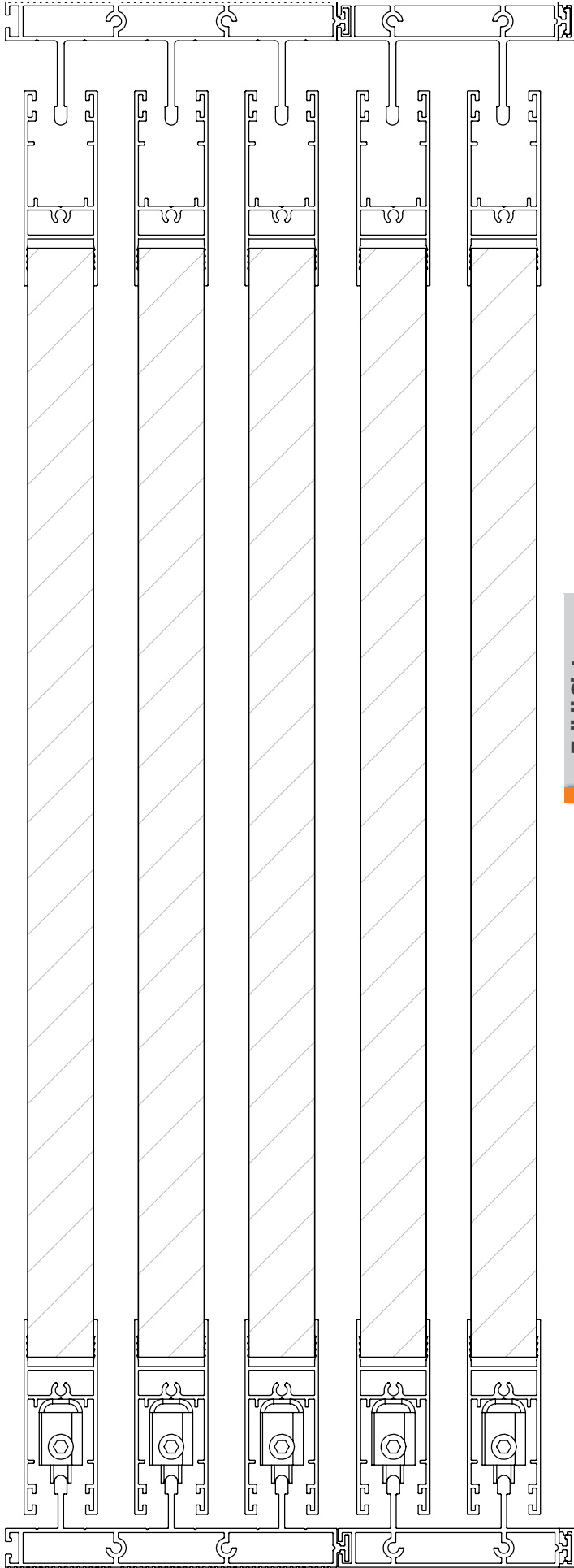

**Eşikli Sistem**  
System with Threshold

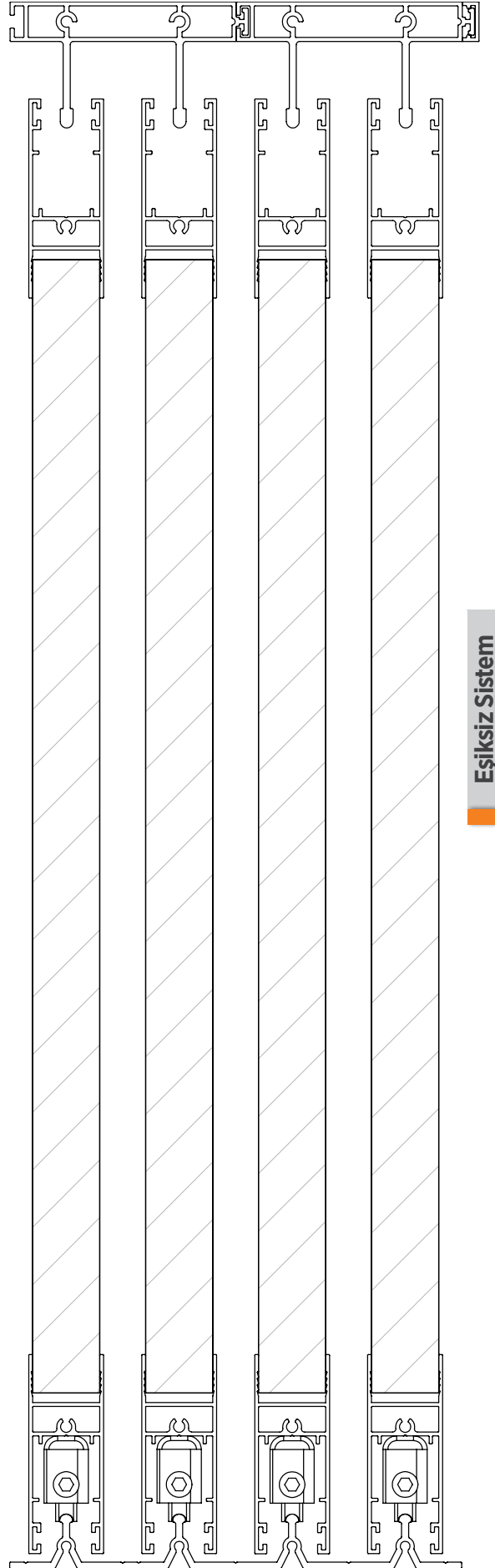

**Eşiksiz Sistem**  
System without Threshold



140

0,563 kg/m

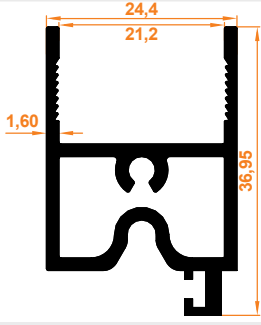

Sabit Panel Açılır Alt Baza Profil  
Fixed Panel Pop-up Base Profile

164

0,842 kg/m

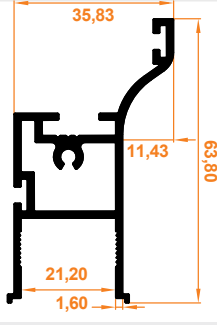

Sabit Panel Yan Dikme Profil  
Fixed Panel Side Column Profile

142

0,750 kg/m

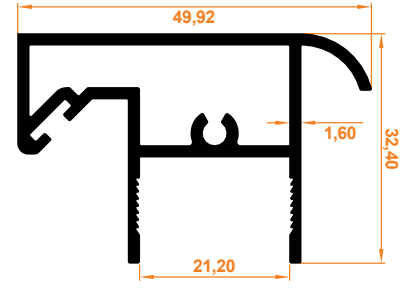

Sabit Panel Üst Baza Profil  
Fixed Panel Top Base Profile

167

1,144 kg/m

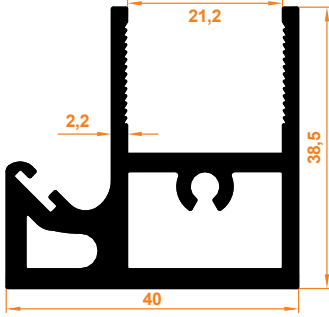

Kenet Baza Profil  
Clamp Base Profile

144

0,434 kg/m

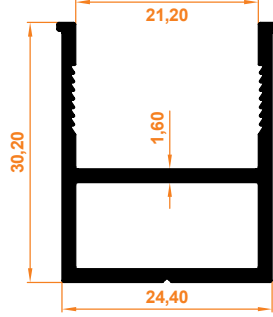

Hareketli Panel Yan Dikme Profil  
Movable Panel Side Column Profile

145

0,579 kg/m

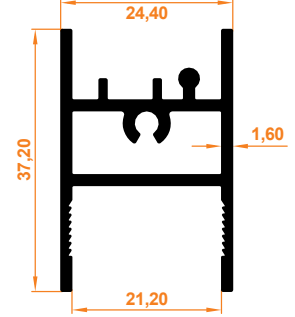

Kúpeşte Baza Profil  
Handrail Base Profile

146

0,741 kg/m

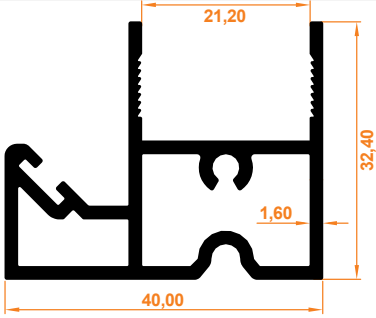

Hareketli Panel Açılır Alt Baza Profil  
Movable Panel Pop-up Lower Base Profile

161

0,482 kg/m

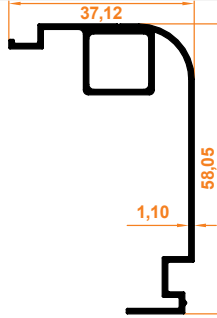

Ray Kapatma "T" Profil  
Rail Closure "T" Profile

160

1,057 kg/m

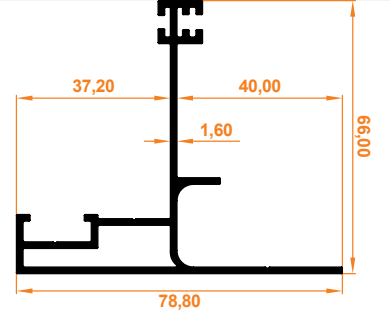

Yan Ray "T" Profil  
Side Rail "T" Profile

166

0,144 kg/m



Açılımlı için Ray Kapatma "L" Profil  
Rail Closure "L" Profile for Opening

162

0,703 kg/m

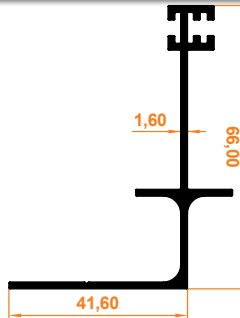

Yan Ray "L" Profil  
Side Rail "L" Profile

GYT 28

2,110 kg/m

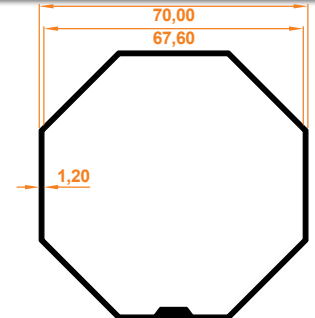

Sac Tambur Borusu  
Sheet Drum Pipe

152

1,563 kg/m

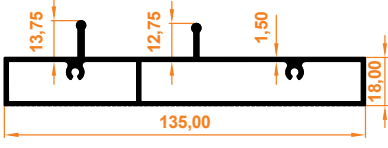

**Alt Kasa**  
Guillotine Lower Case Profile

156

3,449 kg/m

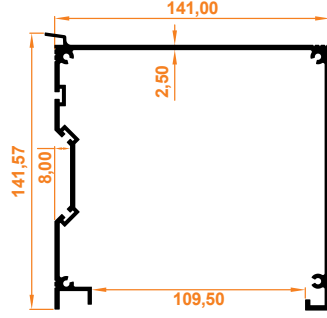

**Üst Kasa Profil**  
Top Case Profile

153

0,864 kg/m

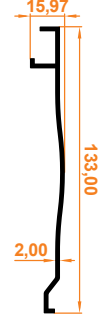

**Üst Kasa Kapak Profil**  
Top Case Cover Profile

155

1,669 kg/m

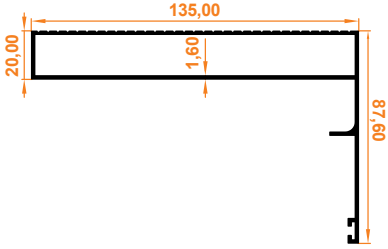

**Yan Kasa Profil**  
Side Case Profile

154

0,759 kg/m

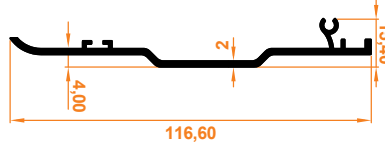

**Küşte Profil**  
Handrail Profile

165

0,644 kg/m



**Yan Kasa Kertme Profil**  
Side Case Notched Profile

158

0,510 kg/m

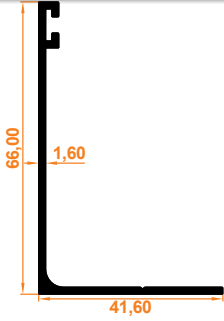

**Açılımsız Tek Fitol Yan Ray L Kasa Profil**  
Single Weatherstrips Without Opening Side L Case Profile

159

0,660 kg/m

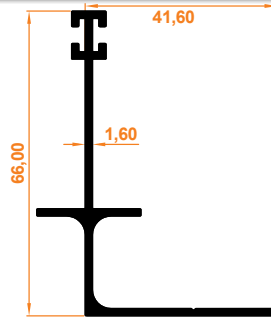

**Açılımsız Çift Fitol Yan Ray L Kasa Profil**  
Double Weatherstrips Without Opening Side L Case Profile

219

0,219 kg/m

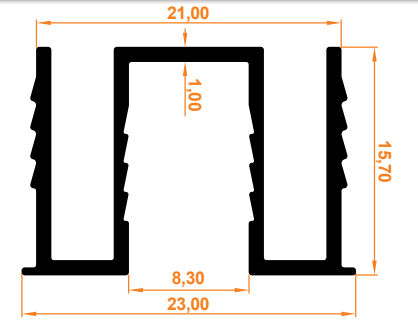

**8 mm Cam Adaptörü**  
8mm Glass Adapter

149

0,162 kg/m

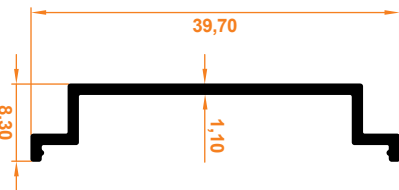

**Açılımsız için Ray Kapatma 'L' Profil**  
Rail Closure 'L' Profile for Non-Opening

## Giyyotin Sistem Çalışma Mekanizması

Guillotine System Operating Mechanism

1. Kademe - Level 1

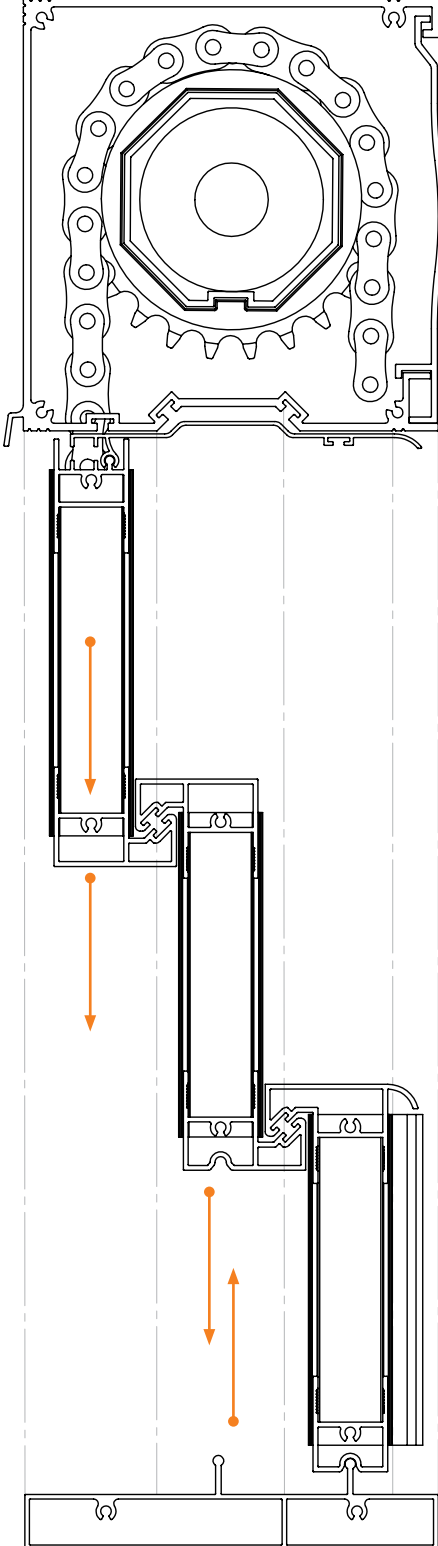

2. Kademe - Level 2

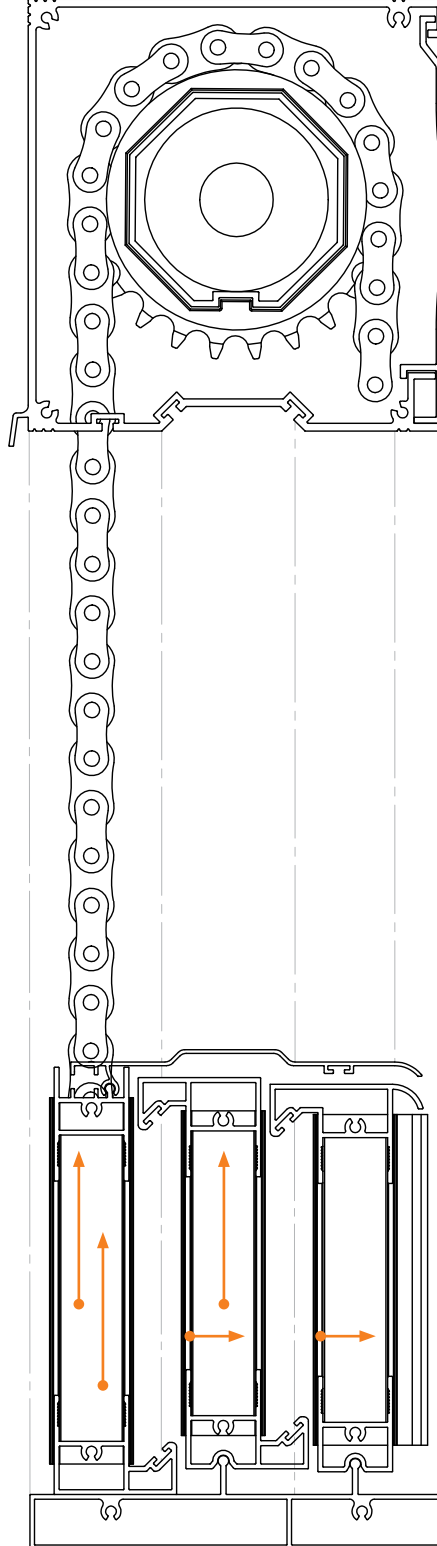

3. Kademe - Level 3

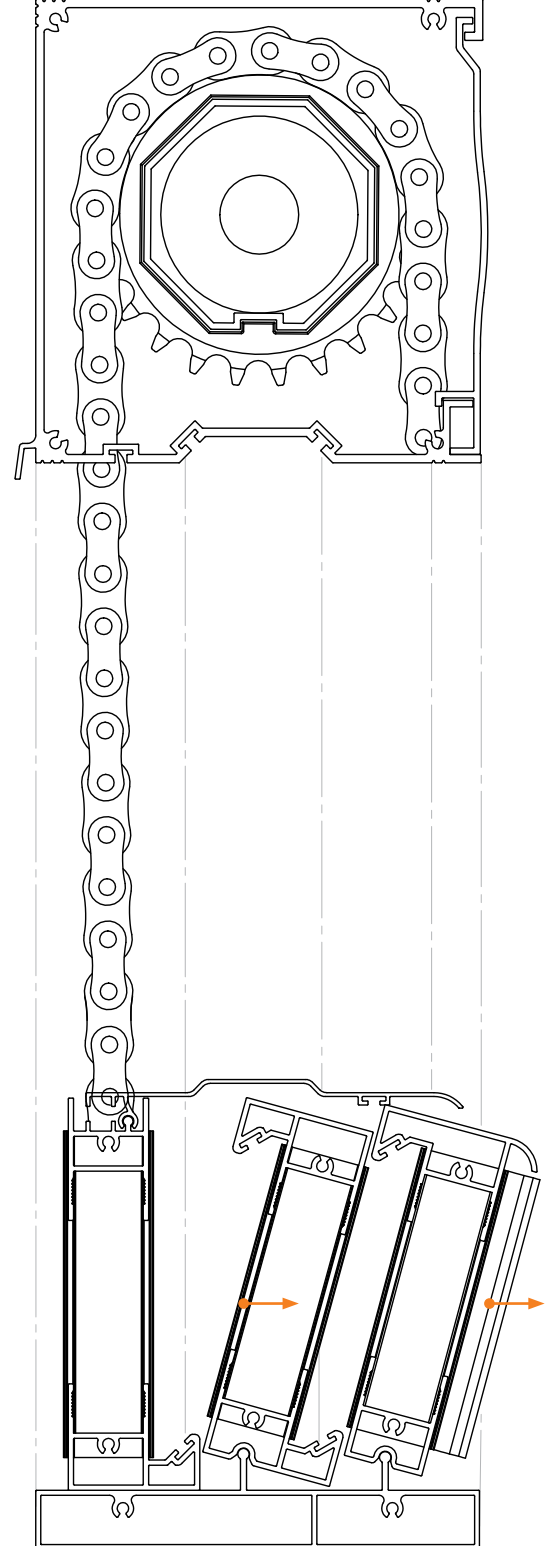

417

0,467 kg/m

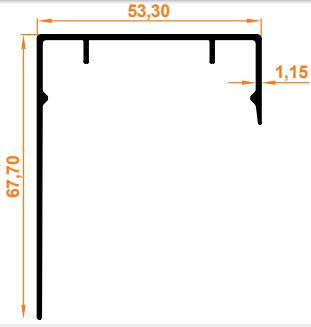

Sonlandırıcı Cam Çıta Kapak Profili  
End Cap Glass Strip Cover Profile

418

0,329 kg/m

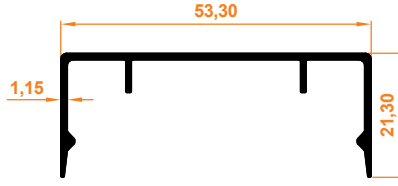

Cam Çıta Kapak Profili  
Glass Strip Cover Profile

419

2,100 kg/m

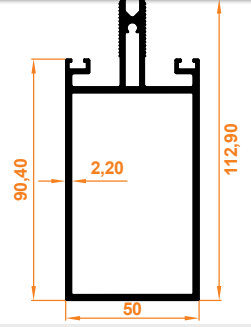

Orta Kayıt Profili  
Center Mullion Profile

420

0,682 kg/m

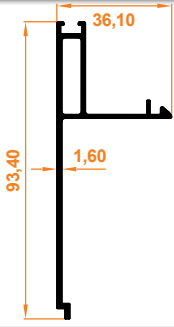

Kasa Kapatma Profili  
Frame Closure Profile

421

3,184 kg/m

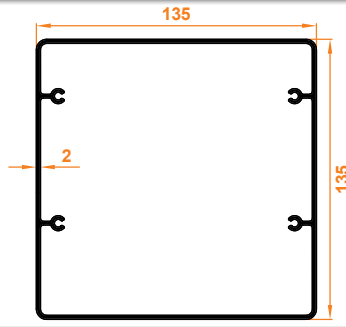

Ayak Profili  
Leg Profile

422

4,318 kg/m

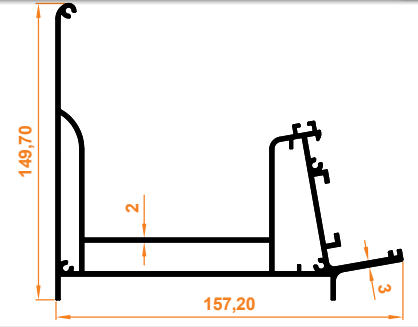

Oluk Profili  
Groove Profile

423

3,142 kg/m

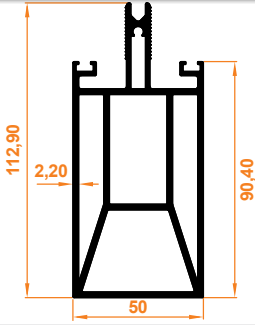

Destekli Orta Kayıt Profili  
Reinforced Center Mullion Profile

424

2,835 kg/m

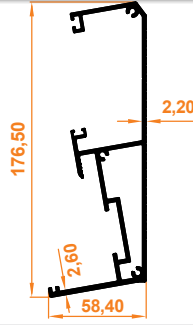

Duvar Kasa Profili  
Wall Frame Profile

425

0,847 kg/m

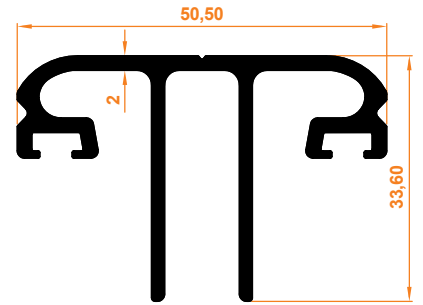

Cam Çıta Profili  
Glass Strip Profile

426

3,434 kg/m

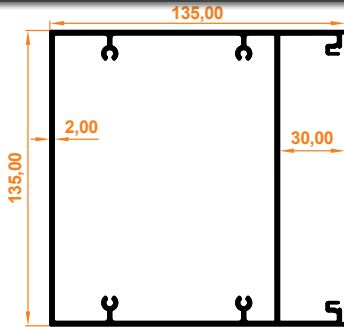

Gizli Ayak Profili  
Hidden Leg Profile

427

2,271 kg/m

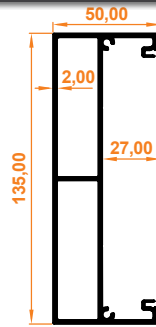

Destek Kutu Profili  
Reinforcing Box Profile

428

0,501 kg/m

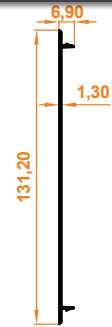

Gizli Ayak ve Destek Kutu Kapatma Profili  
Hidden Leg Case Cover Support Profile

# C60 SERİ ALÜMİNYUM PROFİL GRUBU

C60 Series Aluminum Profile Group

7100

0,921 kg/m

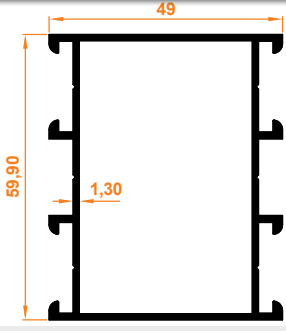

C60 Kasa Orta Kayıt Profili  
C60 Case Mid Entry Profile

7101

0,988 kg/m

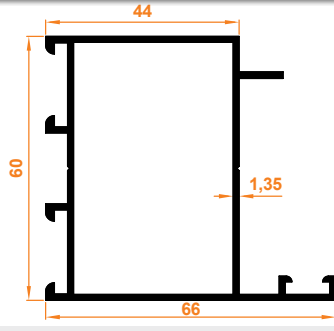

C60 Kanat Profili  
C60 Wing Profile

7102

1,440 kg/m

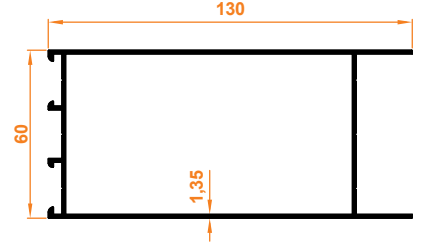

C60 Etek Profili  
C60 Skirt Profile

7103

1,099 kg/m

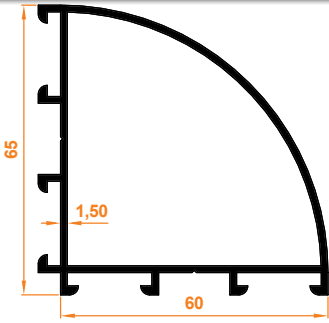

C60 Oval Köşe Dönüş Profili  
C60 Oval Corner Profile

7104

0,436 kg/m

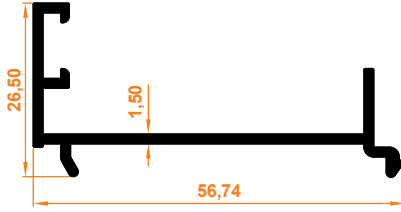

C60 Kanat Adaptörü Profili  
C60 Wing Adapter Profile

7105

1,155 kg/m

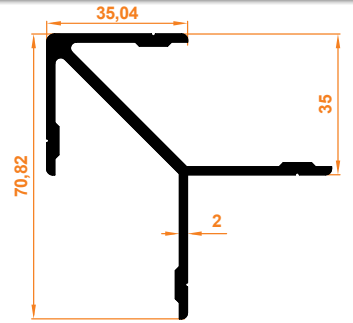

C60 Köşe Takozu  
C60 Corner Wedge

7106

0,467 kg/m

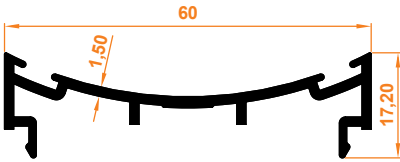

C60 Çarpma Kapı Adaptörü - Dişi  
C60 Crash Door Adapter - Female

7107

0,367 kg/m

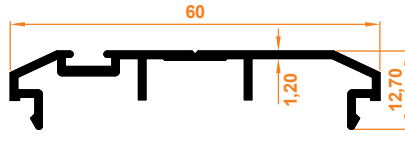

C60 Çarpma Kapı Adaptörü - Erkek  
C60 Crash Door Adapter - Male

7108

0,241 kg/m

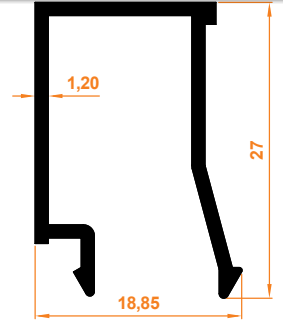

C60 Isıcam Çıta Profili  
C60 Insulating Glass Stave Profile

7109

0,234 kg/m

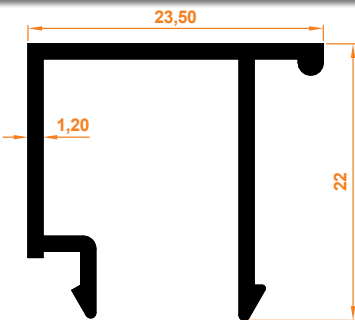

C60 Tek Cam Çıta Profili  
C60 Single Glass Stave Profile

**7000** 0,473 kg/m

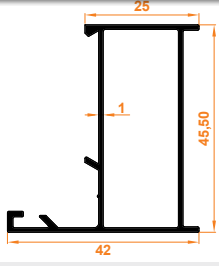

**Aldoks (Dar) Kasa Profili**  
Aldoks (Tight) Frame Profile

**7001** 0,565 kg/m

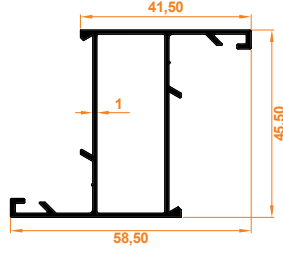

**Aldoks (Dar) Kanat Profili**  
Aldoks (Tight) Wing Profile

**7002** 0,565 kg/m

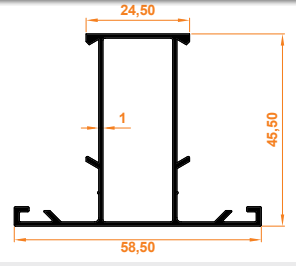

**Aldoks (Dar) Orta Kayıt Profili**  
Aldoks (Tight) Mid Entry Profile

**7003** 0,891 kg/m

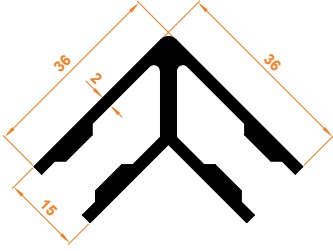

**Aldoks (Dar) Köşe Takozu**  
Aldoks (Tight) Corner Wedge

**7004** 0,565 kg/m

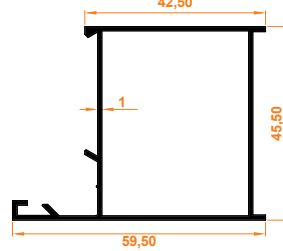

**Aldoks (Orta) Kasa Profili**  
Aldoks (Mid) Frame Profile

**7005** 0,659 kg/m

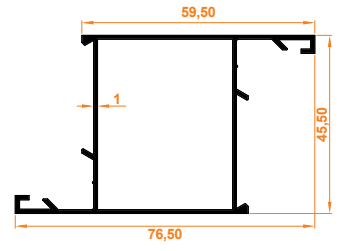

**Aldoks (Orta) Kanat Profili**  
Aldoks (Mid) Wing Profile

**7006** 0,659 kg/m

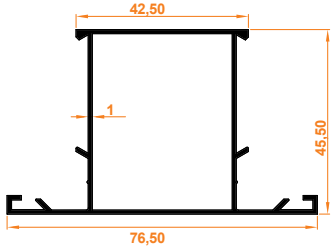

**Aldoks (Orta) Kayıt Profili**  
Aldoks (Mid) Entry Profile

**7007** 1,136 kg/m

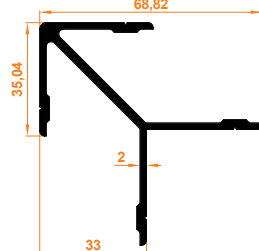

**Aldoks (Orta) Köşe Takozu**  
Aldoks (Mid) Corner Wedge

**7008** 0,695 kg/m

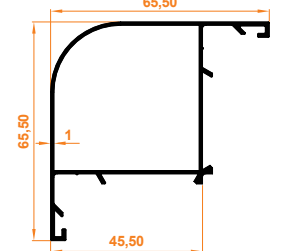

**Aldoks Oval Köşe Dönüş Profili**  
Aldoks Oval Corner Profile

**7009** 0,719 kg/m

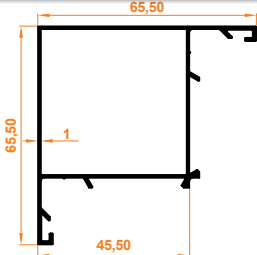

**Aldoks Köşe Dönüş Profili**  
Aldoks Corner Profile

**7010** 1,028 kg/m

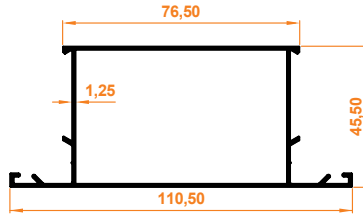

**Aldoks (Geniş) Orta Kayıt Profili**  
Aldoks (Wide) Mid Entry Profile

**7011** 1,028 kg/m

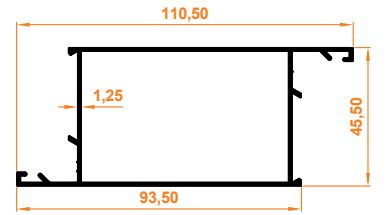

**Aldoks (Geniş) Kanat Profili**  
Aldoks (Wide) Wing Profile

**7012** 1,149 kg/m

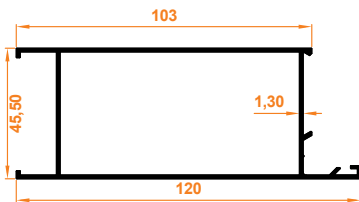

**Aldoks Etek Profili**  
Aldoks Skirt Profile

**7013** 0,215 kg/m

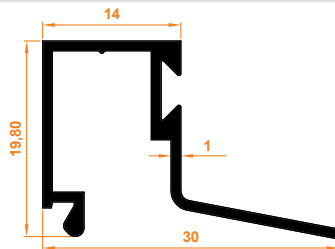

**Aldoks Isıcam Çita**  
Aldoks Double Glazing Stave

**7014** 0,213 kg/m

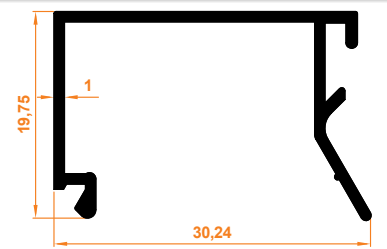

**Aldoks Tek Cam Çita**  
Aldoks Single Glass Stave

700

0,185 kg/m

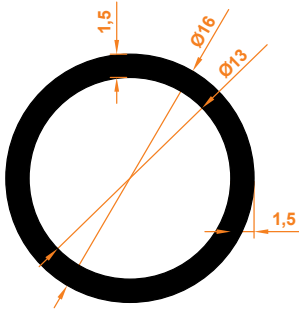

16x1,5 Boru  
16x1,5 Pipe

701

0,538 kg/m

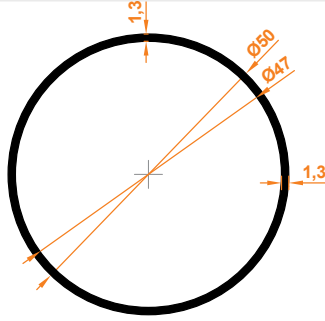

50x1,3 Boru  
50x1,3 Pipe

702

0,509 kg/m

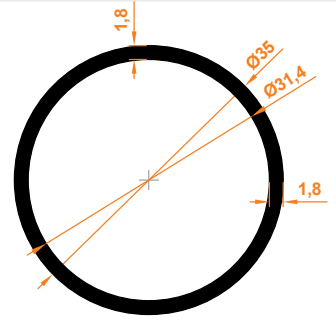

35x1,8 Boru  
35x1,8 Pipe

703

0,182 kg/m

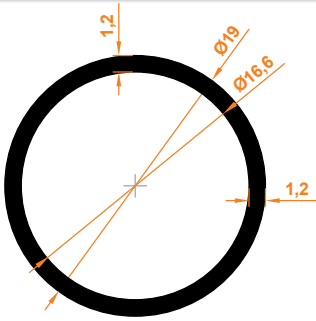

19x1,2 Boru  
19x1,2 Pipe

704

0,162 kg/m

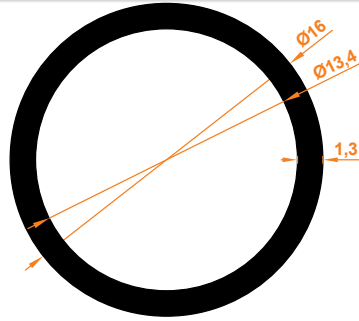

16x1,3 Boru  
16x1,3 Pipe

900

0,685 kg/m

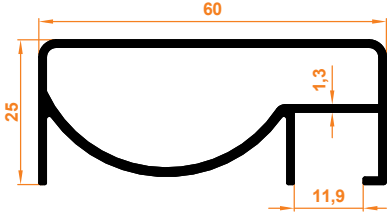

60x25 mm Üst Küpeşte Yandan Kanallı  
60x25 mm Upper Handrail with Side Channel

901

0,230 kg/m

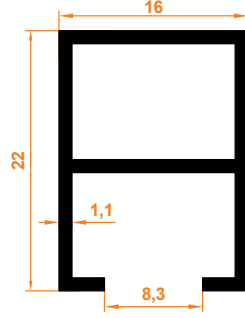

Cam Tutucu  
Glass Holder

902

0,848 kg/m

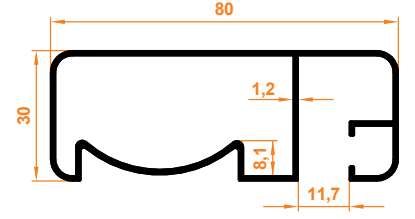

80x30 Yandan Kanallı  
80x30 Side Channel

903

0,785 kg/m

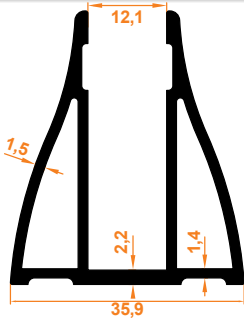

Cam Alt Baza  
Glass Bottom Base

904

0,159 kg/m

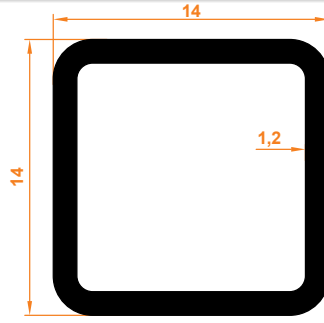

14x14 Emniyet Şeridi  
14x14 Safety Strip

905

0,060 kg/m

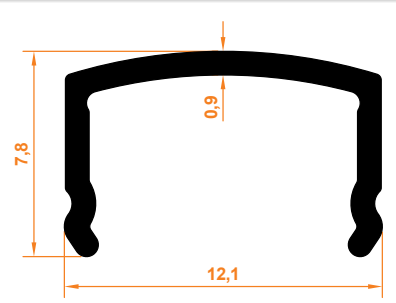

Boru Çıtası  
Pipe Lath

906

0,650 kg/m

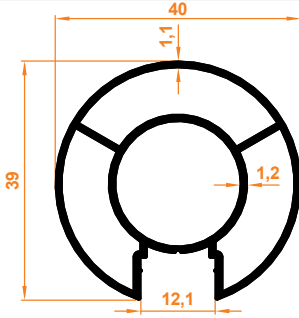

40x1,1 mm Tek Kanallı Çiftli Dikme  
40x1,1 mm Single Channel Double Column

907

0,532 kg/m

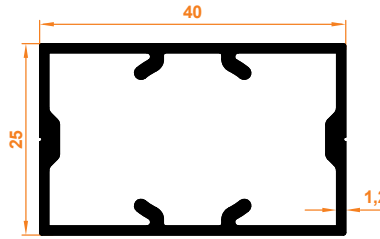

40x25 Dikme  
40x25 Column

908

0,922 kg/m

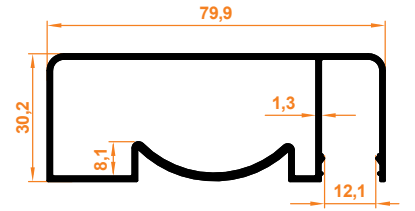

80x30 Yandan Kanallı  
80x30 Side Channel

909

0,717 kg/m

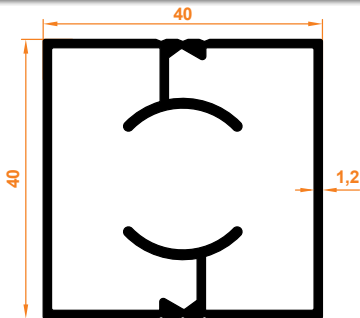

40x40 Kanalsız Dikme  
40x40 Non Channel Column

910

0,631 kg/m

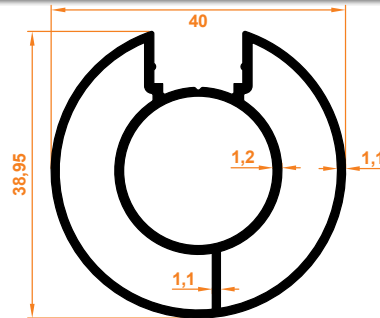

40x1,1 mm Tek Kanallı Tekli Dikme  
40x1,1 mm Single Channel Single Column

911

0,840 kg/m

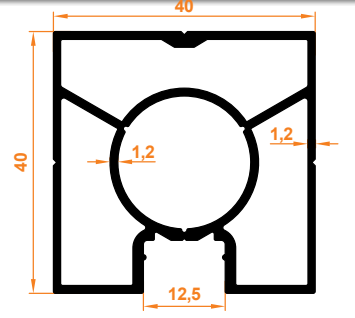

40x40 Tek Kanallı Dikme  
40x40 Single Channel Column



912

0,641 kg/m

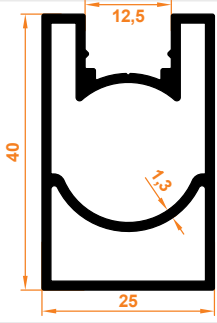

40x25 Tek Kanallı  
40x25 Single Slot

913

0,664 kg/m

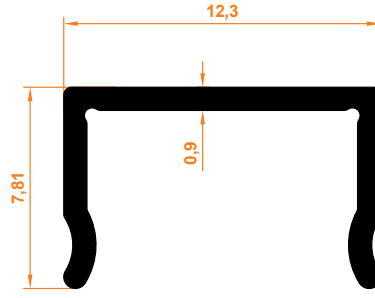

Kare Çıta  
Square Slot

914

0,082 kg/m

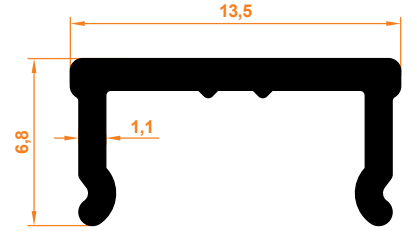

80x30 Yandan Kanallı Çıtası  
80x30 Side Slot Rail

915

0,778 kg/m

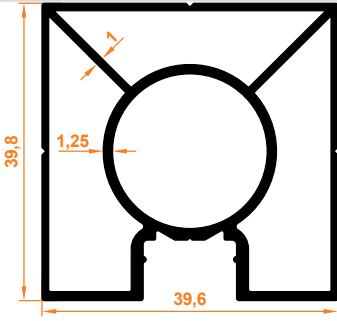

40x40 Tek Kanallı Dikme  
40x40 Single Slot Column

916

0,627 kg/m

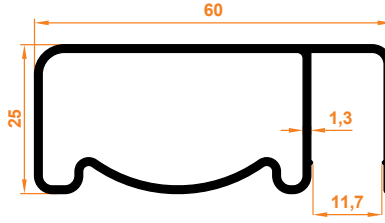

60x25 Yandan Kanallı  
60x25 Side Slot

918

0,256 kg/m

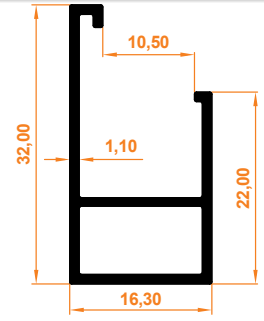

8-10 mm Cam Altı Profil  
8-10 mm Glass Bottom

919

0,807 kg/m

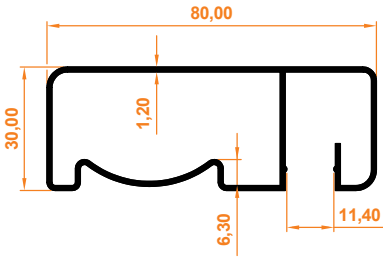

80x30 Yandan Kanallı  
80x30 Side Slot

**250** 1,291 kg/m

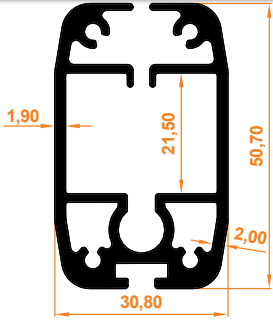

**Kanat Profili**  
Wing Profile

**251** 0,572 kg/m

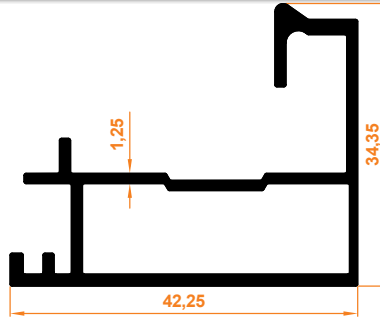

**Yan Kasa Profili**  
Side Case Profile

**252** 0,313 kg/m

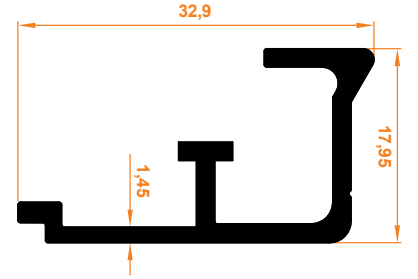

**Yan Kasa Kapak Profili**  
Side Case Cover Profile

**7150** 1,776 kg/m

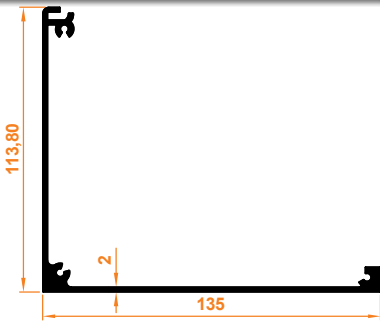

**Üst Kasa Profili**  
Upper Case Profile

**7151** 1,475 kg/m

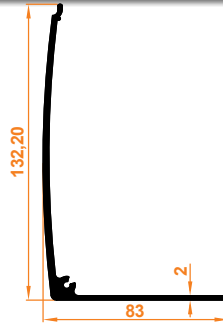

**Üst Kasa Kapak Profili**  
Upper Case Cover Profile

**ZP 13** 2,110 kg/m

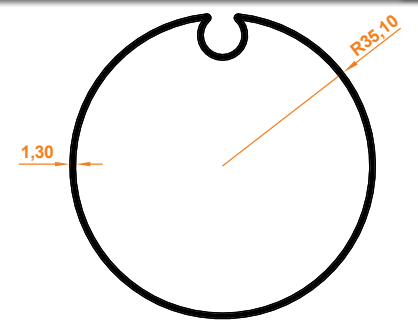

**Sac Tambur Borusu**  
Sheet Drum Tube

**ZP 15** 0,800 kg/m



**5x20 Lama Demir**  
5x20 Blade Iron

312

0,156 kg/m

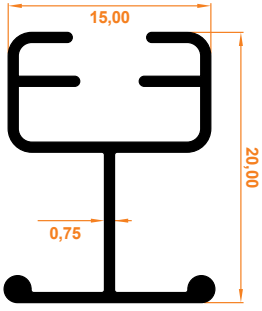

T Profil  
T Profile

334

0,265 kg/m

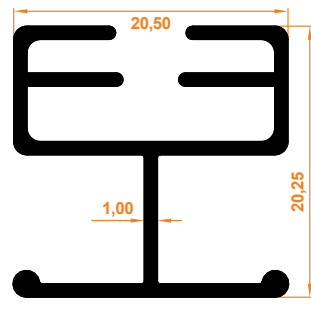

20'lik T Profil  
20 T Profile

339

0,102 kg/m

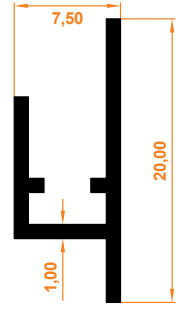

Yaylı Yapışkan Profil  
Spring Adhesive Profile

332

0,094 kg/m

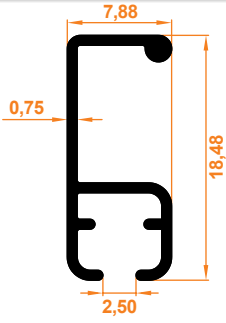

Small T Profil  
Small T Profile

340

0,076 kg/m

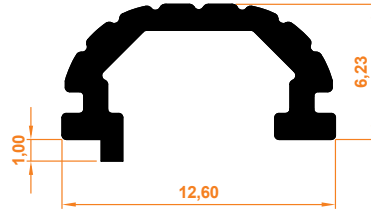

Yaylı Portray Profil  
Spring Portray Profile

327

0,252 kg/m

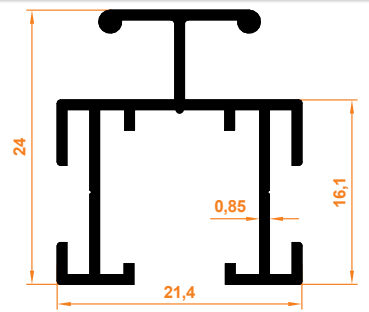

Çiftli Orta Profil  
Double Middle Profile

200

0,136 kg/m

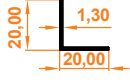

20x20 Köşebent  
20x20 Angle Bracket

201

0,207 kg/m

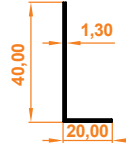

20x40 Köşebent  
20x40 Angle Bracket

202

0,277 kg/m

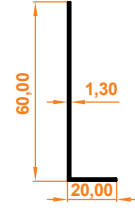

20x60 Köşebent  
20x60 Angle Bracket

204

0,347 kg/m

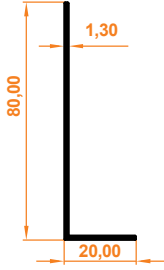

20x80 Köşebent  
20x80 Angle Bracket

203

0,418 kg/m

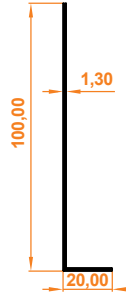

20x100 Köşebent  
20x100 Angle Bracket

205

0,488 kg/m

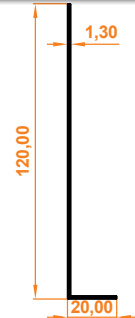

20x120 Köşebent  
20x120 Angle Bracket

206

0,592 kg/m



20x150 Köşebent  
20x150 Angle Bracket

404

0,384 kg/m

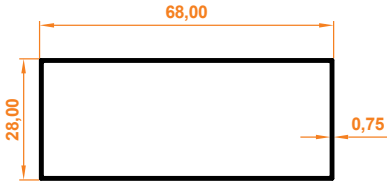

28x68 Kutu Profil  
28x68 Box Profile

1044

0,960 kg/m

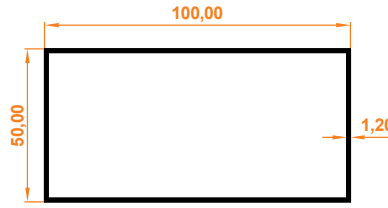

50x100 Kutu Profil  
50x100 Box Profile

1102

0,531 kg/m

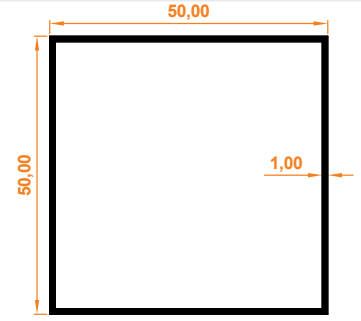

50x50 Kutu Profil  
50x50 Box Profile

1400

0,426 kg/m

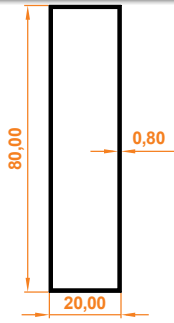

20x80 Kutu Profil  
20x80 Box Profile

1402

0,917 kg/m

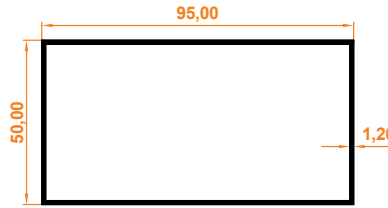

95x50 Kutu Profil  
95x50 Box Profile

1403

0,505 kg/m

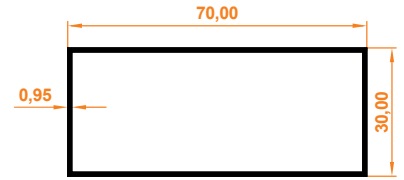

30x70 Kutu Profil  
30x70 Box Profile

920

0,422 kg/m

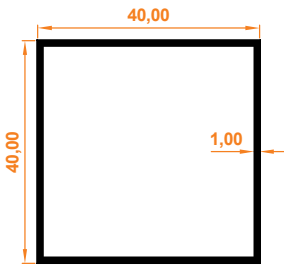

40x40 Kutu Profil  
40x40 Box Profile

921

0,477 kg/m

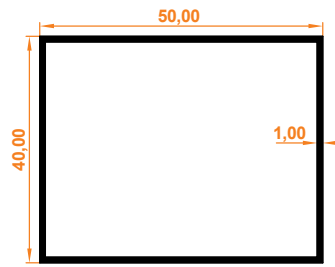

40x50 Kutu Profil  
40x50 Box Profile

922

0,531 kg/m

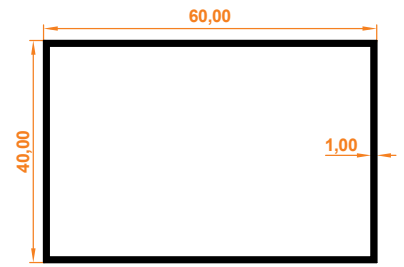

40x60 Kutu Profil  
40x60 Box Profile

7180

0,576 kg/m

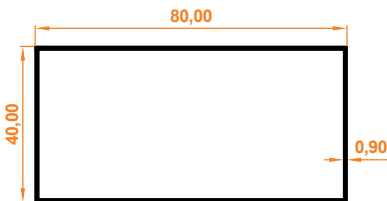

40x80 Kutu Profil  
40x80 Box Profile

**1002** 0,086 kg/m

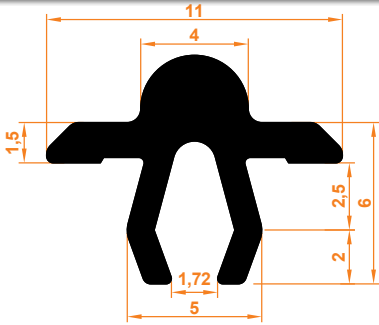

1002 Ray Profil  
1002 Rail Profile

**1063** 0,448 kg/m

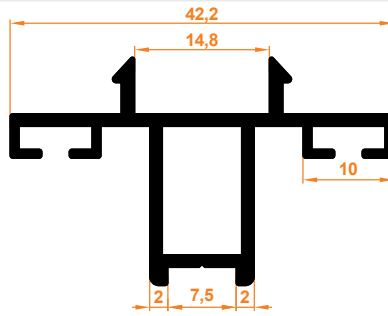

1063 Ray Profil  
1063 Rail Profile

**1064** 0,120 kg/m

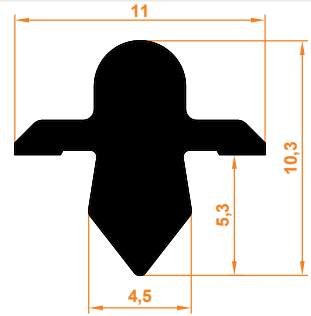

1064 Ray Profil  
1064 Rail Profile

**1104** 0,179 kg/m

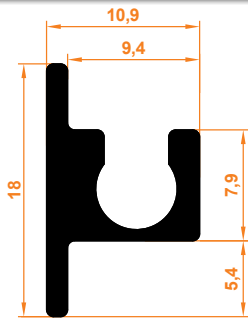

1104 Ray Profil  
1104 Rail Profile

**1531** 0,089 kg/m

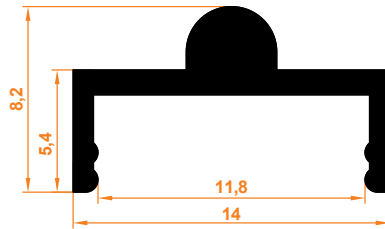

1531 Ray Profil  
1531 Rail Profile

**1532** 0,084 kg/m

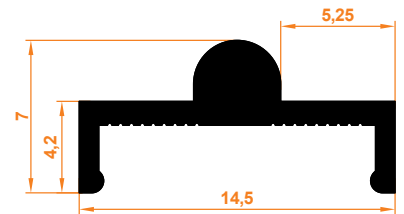

1532 Ray Profil  
1532 Rail Profile

**1550** 0,332 kg/m

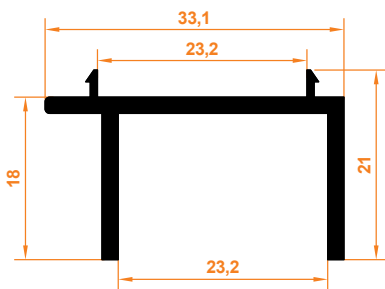

1550 Ray Profil  
1550 Rail Profile

**1551** 0,333 kg/m

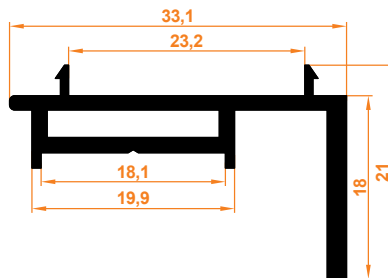

1551 Ray Profil  
1551 Rail Profile

**1552** 0,349 kg/m

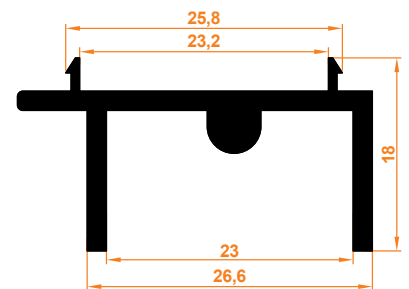

1552 Ray Profil  
1552 Rail Profile

**1553** 0,580 kg/m

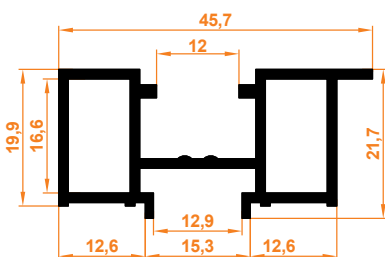

1553 Ray Profil  
1553 Rail Profile

**1560** 0,105 kg/m

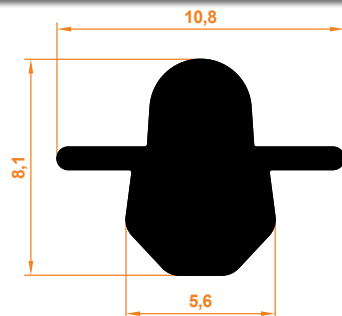

1560 Ray Profil  
1560 Rail Profile

**1570** 0,357 kg/m

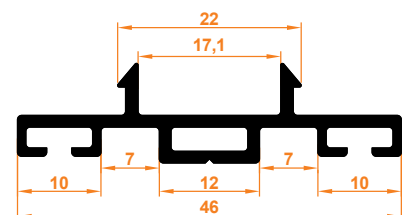

1570 Ray Profil  
1570 Rail Profile

1571

0,590 kg/m

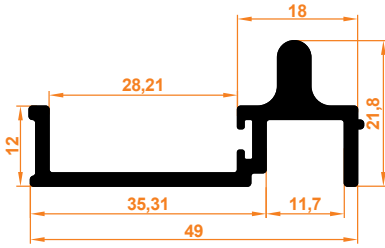

1571 Ray Profil  
1571 Rail Profile

1572

0,454 kg/m

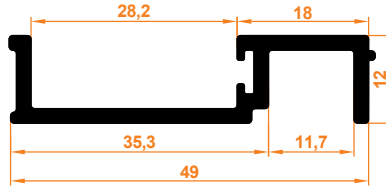

1572 Ray Profil  
1572 Rail Profile

1573

0,173 kg/m

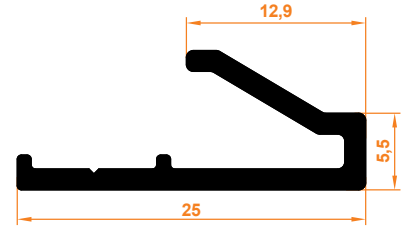

1573 Ray Profil  
1573 Rail Profile

1574

0,423 kg/m

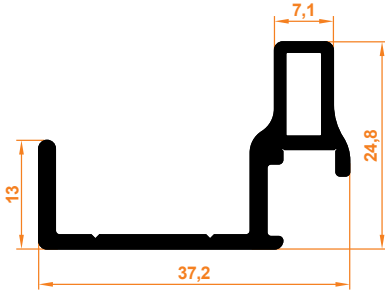

1574 Ray Profil  
1574 Rail Profile

1575

0,485 kg/m

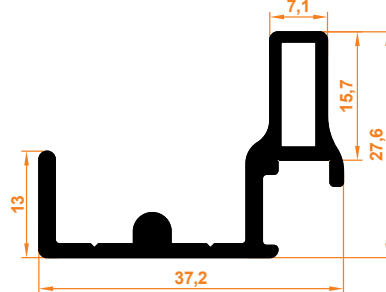

1575 Ray Profil  
1575 Rail Profile

1576

0,560 kg/m

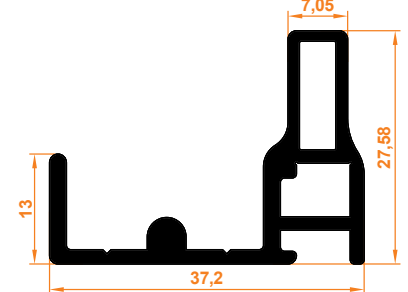

1576 Ray Profil  
1576 Rail Profile

1577

0,490 kg/m

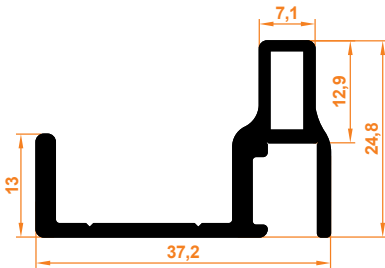

1577 Ray Profil  
1577 Rail Profile

7

0,305 kg/m

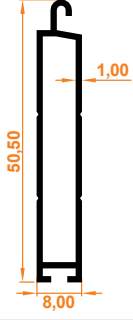

39x55 Alt Parça  
39x55 Lower Part

8

0,502 kg/m

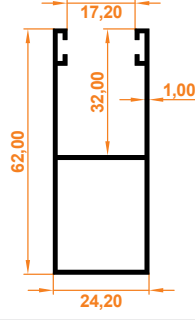

55'lik Yan Dikme  
55 Side Column

9

0,439 kg/m

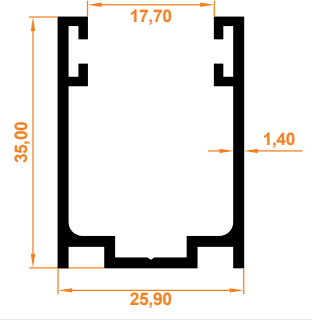

55'lik Kutusuz Dikme  
55 Side Column Boxless

1130

0,372 kg/m

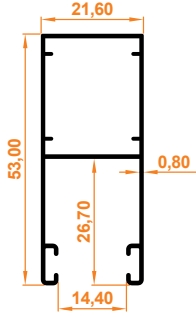

39'luk Yan Dikme  
39 Side Column

**ÖZEL ÜRETİM PROFİL GRUBU**  
Special Production Profile Group

510

1,174 kg/m

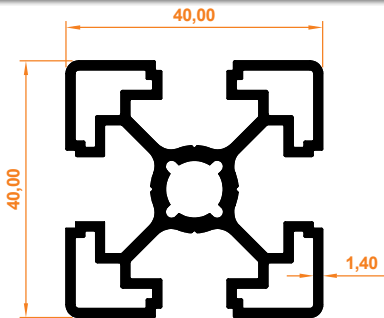

40x40 Sigma Profil  
40x40 Sigma Profile

1003

0,053 kg/m

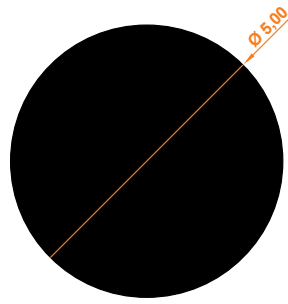

Q5 Dolu Mil  
Q5 Solid Bar



İNNOVATİF ÜRETİM  
**GENİŞ BAYİ AĞI**

Sektörde Öncü Marka



INNOVATIVE PRODUCTION  
**WIDE DISTRIBUTOR NETWORK**

Leading Brand in the Industry





 demarco  panjurmen  prosin  process plise

 Process Alüminyum Plastik San. Tic. Ltd. Şti.

#### MERKEZ

Aşağıpınarbaşı OSB Mah. 524 Nolu Sk. No: 3/1  
42250, Selçuklu-Konya/TÜRKİYE

T : +90 332 248 00 92

F : +90 332 248 00 93

M : info@process.com.tr

#### MARMARA BÖLGE MÜDÜRLÜĞÜ

Cihangir Mh. Talatpaşa Cad. No:67  
Avcılar/İSTANBUL - TÜRKİYE

T : +90 212 407 17 42

F : +90 212 407 15 42

M : marmara@process.com.tr

[www.demarco.com.tr](http://www.demarco.com.tr)

[www.processplise.com.tr](http://www.processplise.com.tr)

[www.panjurmen.com.tr](http://www.panjurmen.com.tr)

[www.prosin.com.tr](http://www.prosin.com.tr)

[www.process.com.tr](http://www.process.com.tr)

