



2025

v.08



Alüminyum Profil Kataloğu
Aluminium Profile Catalogue

ALÜMİNYUM PROFİL GRUBU

Aluminium Profile Group

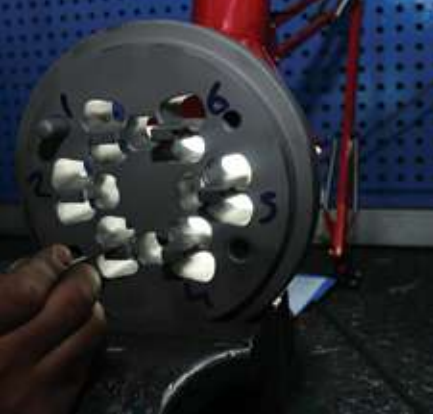

ISO 9001 | ISO 14001 | OHSAS 18001

GOLD SERİ PLİSE SİNEKLİK / GOLD SERIES PLAİT FLY SCREEN

304

0,318 kg/m

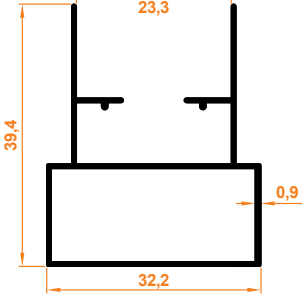

305

0,330 kg/m

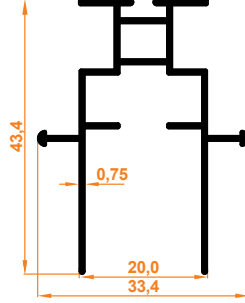

Gold Kasa Profil
Gold Case Profile

Paket İçi Adet
Quantity Per Package

10

Gold Kanat Profil
Gold Wing Profile

Paket İçi Adet
Quantity Per Package

10

STAR SERİ PLİSE SİNEKLİK / STAR SERIES PLAİT FLY SCREEN

356

0,271 kg/m

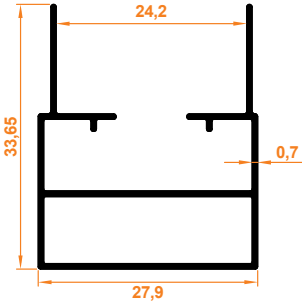

307

0,304 kg/m

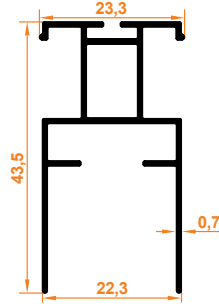

Star Kasa Profil
Star Case Profile

Paket İçi Adet
Quantity Per Package

10

Star Kanat Profil
Star Wing Profile

Paket İçi Adet
Quantity Per Package

10

JUNIOR SERİ PLİSE SİNEKLİK / JUNIOR SERIES PLAİT FLY SCREEN

306

0,243 kg/m

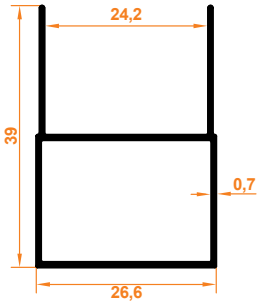

307

0,304 kg/m

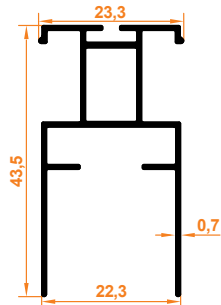

345

0,162 kg/m

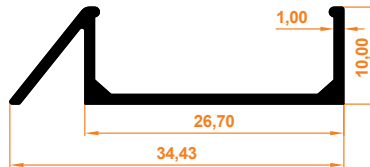

347

0,445 kg/m

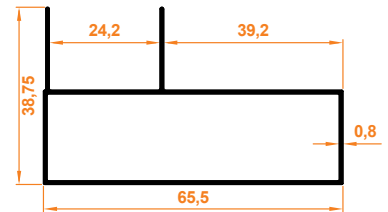

Junior Kasa Profil
Junior Case Profile

Paket İçi Adet
Quantity Per Package

10

Junior Kanat Profil
Junior Wing Profile

Paket İçi Adet
Quantity Per Package

10

Junior Eşiksiz Kasa Profil
Junior Case Profile without Threshold

Paket İçi Adet
Quantity Per Package

12

Junior Büyük Kasa Profili
Junior Big Case Profile

Paket İçi Adet
Quantity Per Package

8

SLIM SERİ PLİSE SİNEKLİK / SLIM SERIES PLAİT FLY SCREEN

300 0,218 kg/m

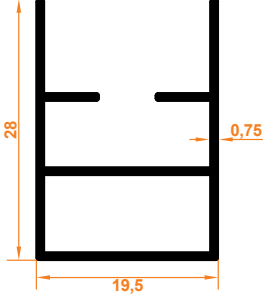

Slim Kasa Profil
Slim Case Profile

Paket İçi Adet
Quantity Per Package

10

358 0,111 kg/m

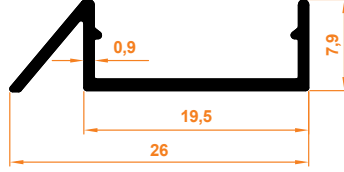

Slim Eşiksiz Profil
Slim Profile without Threshold

Paket İçi Adet
Quantity Per Package

12

359 0,321 kg/m

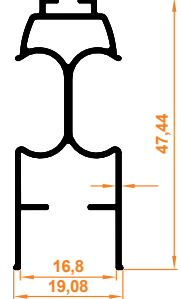

Slim Kant Profil
Slim Wing Profile

Paket İçi Adet
Quantity Per Package

10

NOBEL SERİ PLİSE SİNEKLİK / NOBEL SERIES PLAİT FLY SCREEN

335 0,345 kg/m

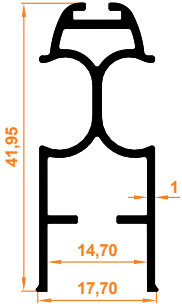

Nobel Kanat Profili
Nobel Wing Profile

Paket İçi Adet
Quantity Per Package

10

355 0,098 kg/m

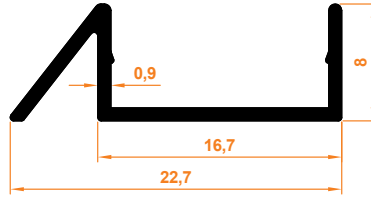

Nobel Eşiksiz Profili
Nobel Profile without Threshold

Paket İçi Adet
Quantity Per Package

12

338 0,250 kg/m

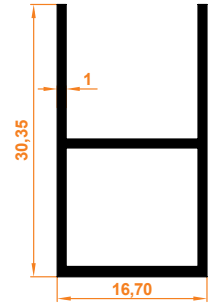

Nobel Kasa Profili
Nobel Case Profile

Paket İçi Adet
Quantity Per Package

10

SÜPER SERİ PLİSE SİNEKLİK / SUPER SERIES PLAIT FLY SCREEN

320

0,303 kg/m

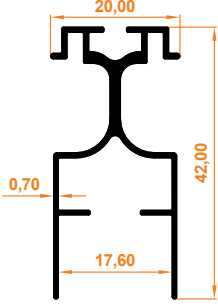

Süper Seri Kanat Profili
Super Wing Profile

Paket İçi Adet
Quantity Per Package

10

316

0,248 kg/m

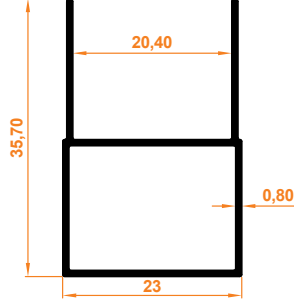

Süper Seri Kasa Profili
Super Case Profile

Paket İçi Adet
Quantity Per Package

10

325

0,469 kg/m

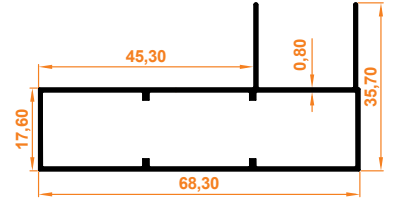

Süper Büyük Kasa Profili
Super Big Case Profile

Paket İçi Adet
Quantity Per Package

8

354

0,363 kg/m

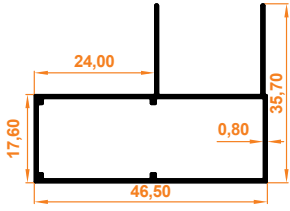

Süper Orta Kasa Profili
Super Middle Case Profile

Paket İçi Adet
Quantity Per Package

8

361

0,152 kg/m

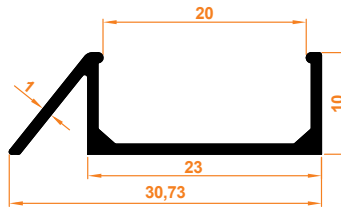

Süper Eşiksiz Kasa Profili
Super without Threshold Case Profile

Paket İçi Adet
Quantity Per Package

12

NOBEL SERİ İÇTEN MONTAJLI PLİSE SİNEKLİK / NOBEL SERIES INTERNAL MOUNTED PLAIT FLY SCREEN

337

0,338 kg/m

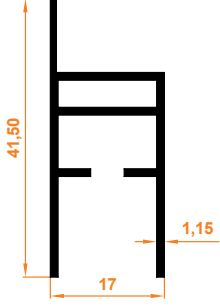

335

0,345 kg/m

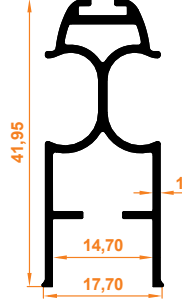

Nobel İçten Montajlı Kasa Profili
Nobel Internal Mounted Case Profile

Paket İçi Adet
Quantity Per Package

10

Nobel Kanat Profili
Nobel Wing Profile

Paket İçi Adet
Quantity Per Package

10

SLIM SERİ İÇTEN MONTAJLI PLİSE SİNEKLİK / SLIM SERIES INTERNAL MOUNTED PLAIT FLY SCREEN

317

0,272 kg/m

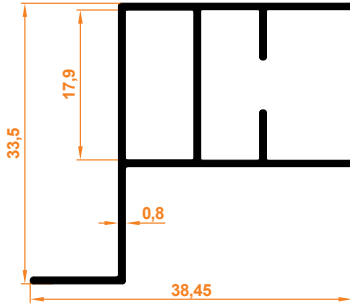

359

0,321 kg/m

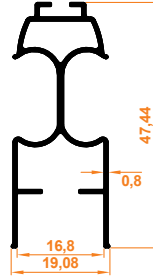

Kasa Profil
Case Profile

Paket İçi Adet
Quantity Per Package

10

Slim Kanat Profili
Slim Wing Profile

Paket İçi Adet
Quantity Per Package

10

İÇTEN MONTAJLI SABİT SİNEKLİK / INTERNAL MOUNTED FIXED FLY SCREEN

405

0,256 kg/m

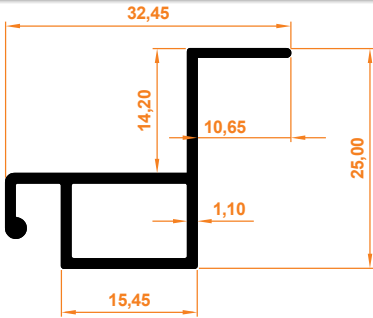

Kasa Profili
Case Profile

Paket İçi Adet
Quantity Per Package

10

AYKİM SERİ SİNEKLİK / AYKİM SERIES FLY SCREEN

309

0,374 kg/m

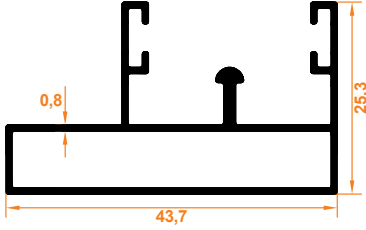

310

0,315 kg/m

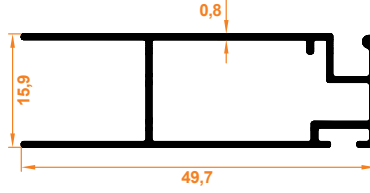

Aykim Kasa Profil
Aykim Case Profile

Paket İçi Adet
Quantity Per Package

8

Aykim Hareketli Profil
Aykim Sliding Profile

Paket İçi Adet
Quantity Per Package

10

PLATİN SERİ SİNEKLİK / PLATİN SERIES FLY SCREEN

321

0,352 kg/m

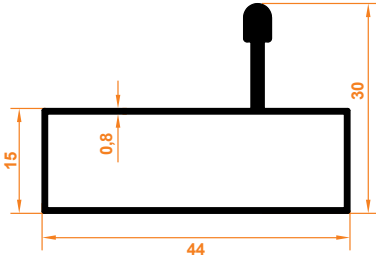

322

0,455 kg/m

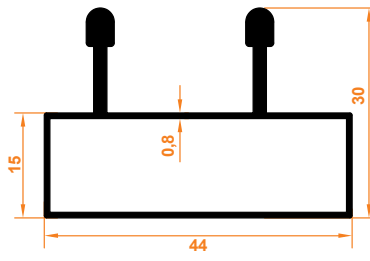

323

0,506 kg/m

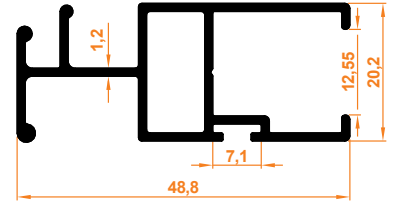

Platin Tekli Kasa Profil
Platin Single Case Profile

Paket İçi Adet
Quantity Per Package

8

Platin Çiftli Kasa Profil
Platin Double Case Profile

Paket İçi Adet
Quantity Per Package

6

Platin Kanat Profil
Platin Series Sash Profile

Paket İçi Adet
Quantity Per Package

10

360

0,306 kg/m

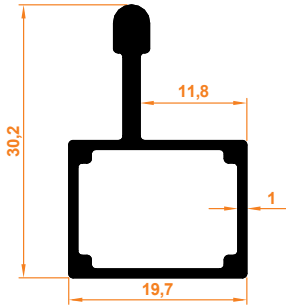

Platin Tekli Dar Kasa Profil
Platin Series Single Slim Frame Profile

Paket İçi Adet
Quantity Per Package

8

DÜZ SİNEKLİK SİSTEMLERİ / FLAT FLY SCREEN PROFILE GROUP

400

0,105 kg/m

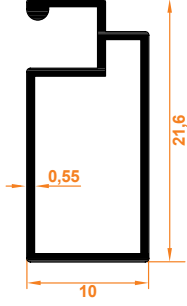

10x20 Sineklik Profil
10x20 Fly Screen Profile

Paket İçi Adet | 20
Quantity Per Package

401

0,142 kg/m

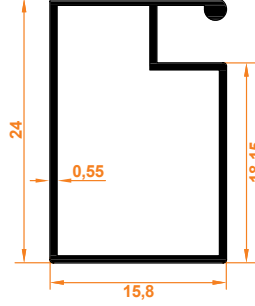

17x25 Sineklik Profil
17x25 Fly Screen Profile

Paket İçi Adet | 20
Quantity Per Package

402

0,250 kg/m



20x40 Sineklik Profil
20x40 Fly Screen Profile

Paket İçi Adet | 10
Quantity Per Package

311

0,304 kg/m

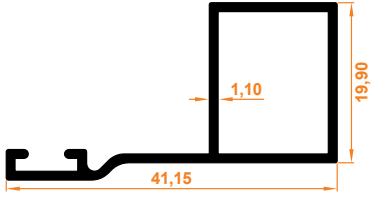

İçe Açılır Fitilli Sineklik Profil
Inward Foldable Flyscreen Profile

Paket İçi Adet | 10
Quantity Per Package

407

0,342 kg/m

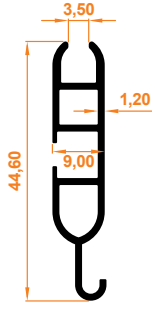

Stor Kanat Profil
Stor Wing Profile

Paket İçi Adet
Quantity Per Package

6

408

0,286 kg/m

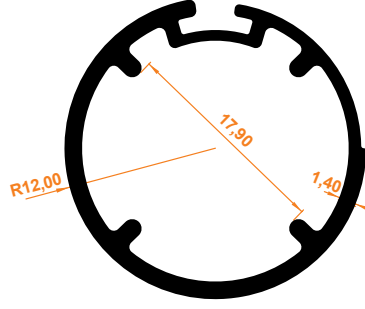

Stor Boru Profil
Stor Pipe Profile

Paket İçi Adet
Quantity Per Package

6

409

0,526 kg/m

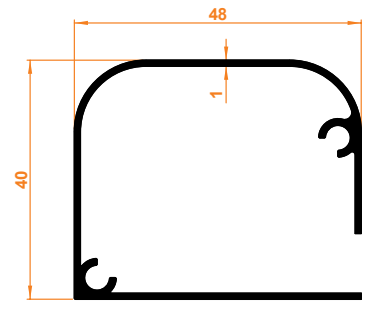

Stor Kasa Profil
Stor Case Profile

Paket İçi Adet
Quantity Per Package

6

410

0,413 kg/m

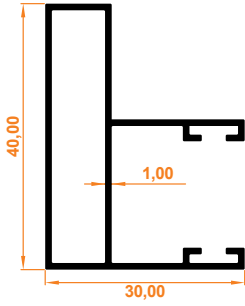

Stor Yan Kasa Profil
Stor Side Case Profile

Paket İçi Adet
Quantity Per Package

6

411

0,318 kg/m

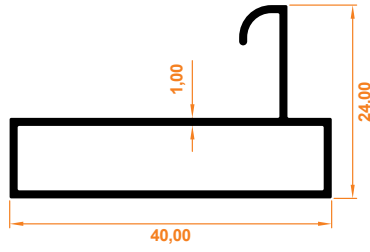

Stor Alt Kasa Profil
Stor Bottom Case Profile

Paket İçi Adet
Quantity Per Package

6

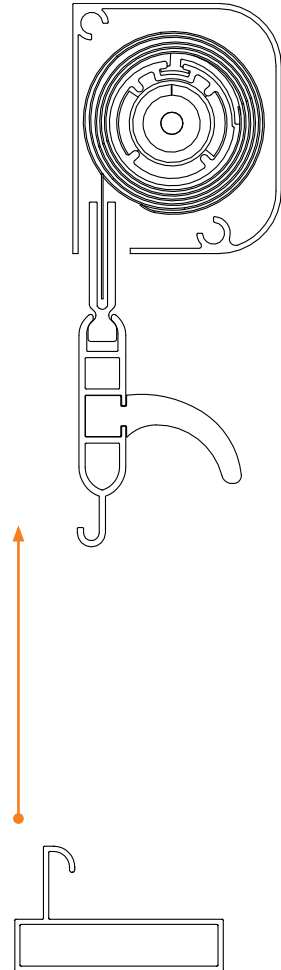
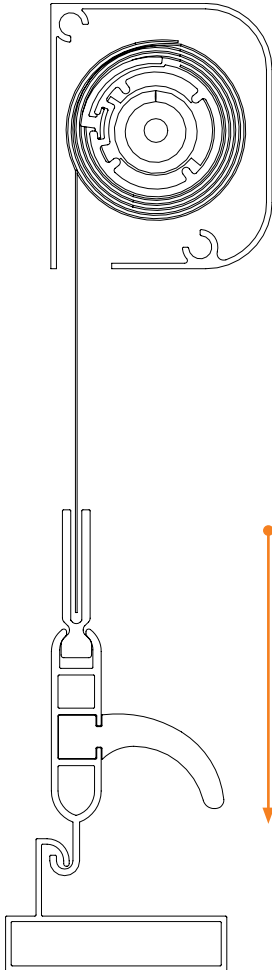

1

0,247 kg/m

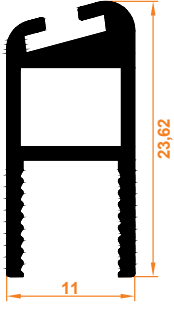

Büyük D Fitol
Big D Wick

Paket İçi Adet
Quantity Per Package

10

2

0,167 kg/m

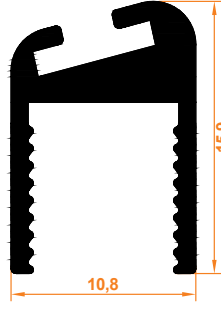

Küçük D Fitol
Small D Wick

Paket İçi Adet
Quantity Per Package

10

3

0,116 kg/m

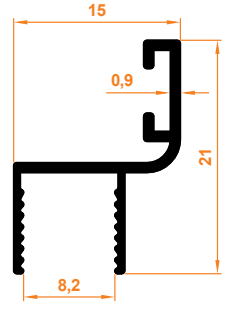

Küçük h Fitol
Small h Wick

Paket İçi Adet
Quantity Per Package

20

4

0,150 kg/m

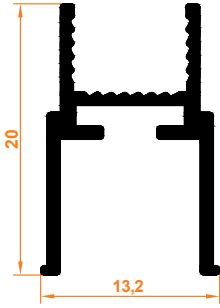

Orta H Fitol
Medium H Wick

Paket İçi Adet
Quantity Per Package

10

5

0,214 kg/m

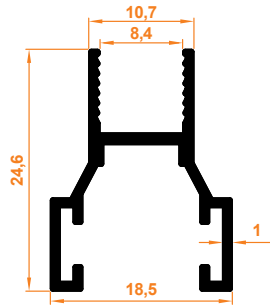

Büyük H Fitol
Big H Wick

Paket İçi Adet
Quantity Per Package

20

6

0,276 kg/m

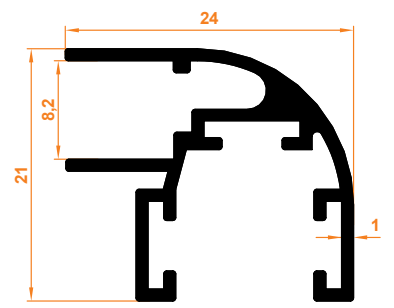

Köşe Dönüş Fitol
Corner Return Wick

Paket İçi Adet
Quantity Per Package

10

8 mm CAM BALKON PROFİL GRUBU

8 mm Glass Balcony Profile Group

101

0,078 kg/m

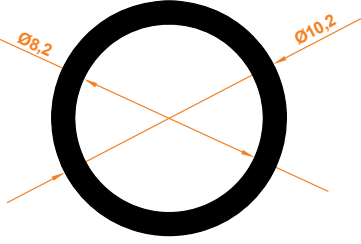

10'lu Stoplama
10 Stopping Profile

Paket İçi Adet
Quantity Per Package

25

104

0,717 kg/m

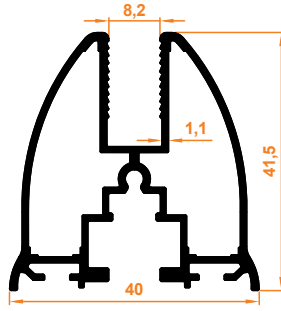

Gold Baza Profil
Gold Base Profile

Paket İçi Adet
Quantity Per Package

3

105

0,730 kg/m

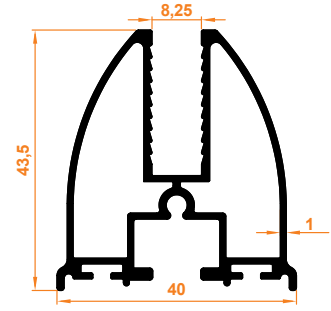

Firtına Baza Profil
Firtına Base Profile

Paket İçi Adet
Quantity Per Package

3

109

1,355 kg/m

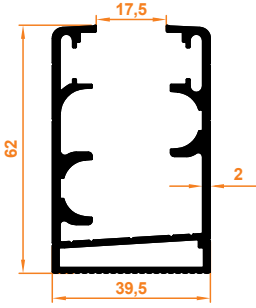

Düz Kasa Profil
Flat Case Profile

Paket İçi Adet
Quantity Per Package

3

110

1,396 kg/m

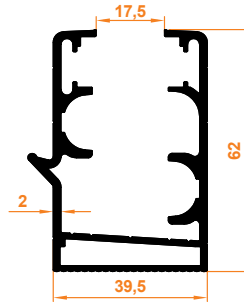

Oluklu Kasa Profil
Corrugated Case Profile

Paket İçi Adet
Quantity Per Package

3

100

0,441 kg/m

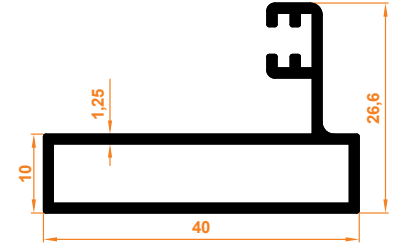

Dar Yan Dikme
Thin Side Column

Paket İçi Adet
Quantity Per Package

6

106

1,611 kg/m

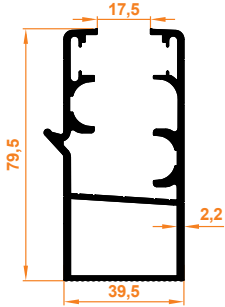

Oluklu Büyük Kasa Profil
Corrugated Big Case Profile

Paket İçi Adet
Quantity Per Package

3

107

1,570 kg/m

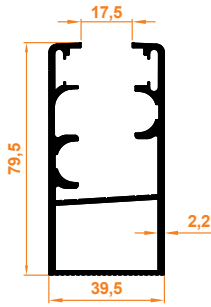

Büyük Düz Kasa Profil
Big Flat Case Profile

Paket İçi Adet
Quantity Per Package

3

108

0,457 kg/m

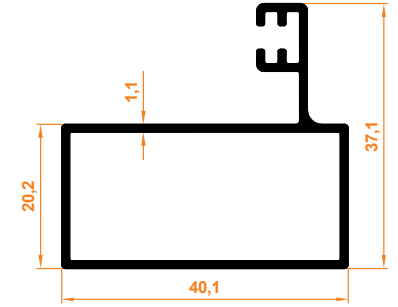

Geniş Yan Dikme
Thick Side Column Profile

Paket İçi Adet
Quantity Per Package

6

111

1,062 kg/m

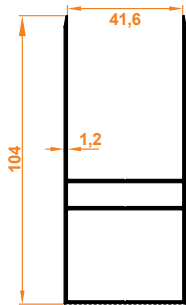

Stor Profil
Stor Profile

Paket İçi Adet
Quantity Per Package

3

135

0,517 kg/m

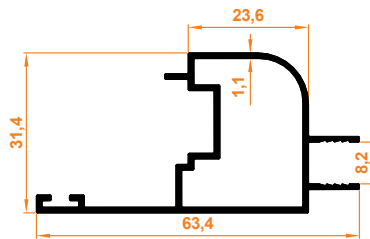

8 mm İspanyolet Profil
8 mm Espagnolette Profile

Paket İçi Adet
Quantity Per Package

4

136

0,343 kg/m

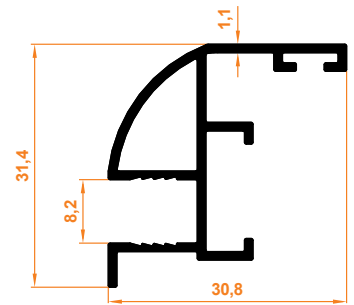

8 mm İspanyolet Profil Karşılığı
8 mm Espagnolette Combination Profile

Paket İçi Adet
Quantity Per Package

8

800 0,618 kg/m

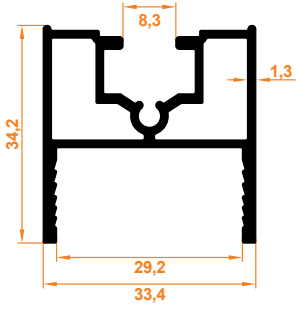

Baza Profil
Base Profile

Paket İçi Adet | 6
Quantity Per Package

801 0,321 kg/m

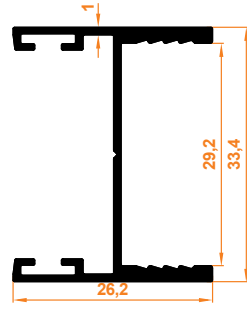

Düz Kapak Profil
Flat Cover Profile

Paket İçi Adet | 6
Quantity Per Package

802 0,327 kg/m

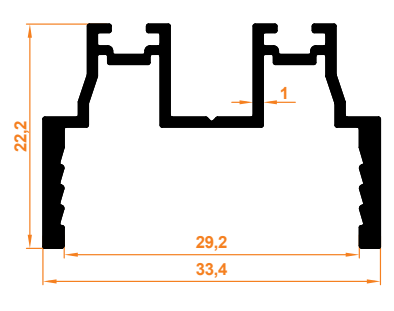

Düz Kapak Mentеше Profil
Flat Cover with Hinge Profile

Paket İçi Adet | 6
Quantity Per Package

803 0,445 kg/m

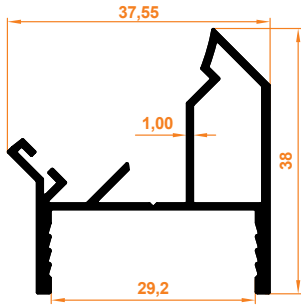

45° Dönüş Profil
45° Return Profile

Paket İçi Adet | 6
Quantity Per Package

804 0,378 kg/m

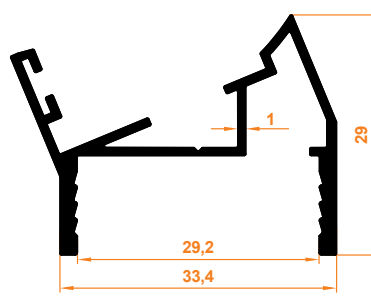

22,5° Dönüş Profil
22,5° Return Profile

Paket İçi Adet | 6
Quantity Per Package

805 0,366 kg/m

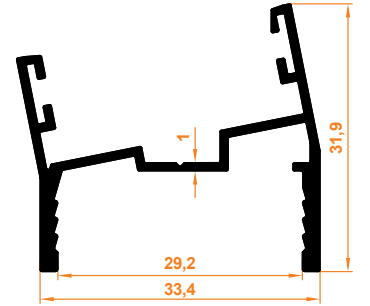

11° Dönüş Profil
11° Return Profile

Paket İçi Adet | 6
Quantity Per Package

806 0,475 kg/m

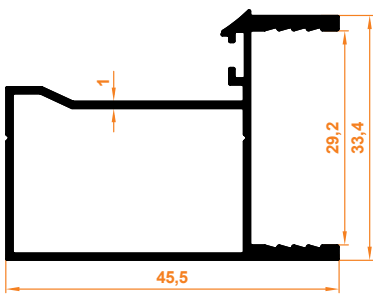

90° Dönüş Profil
90° Return Profile

Paket İçi Adet | 6
Quantity Per Package

807 0,346 kg/m

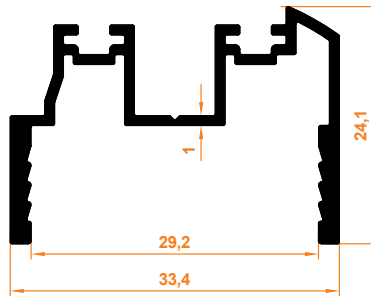

Açılı Dönüş Mentеше Profil
PopUp Return Hinge Profile

Paket İçi Adet | 6
Quantity Per Package

808 0,369 kg/m

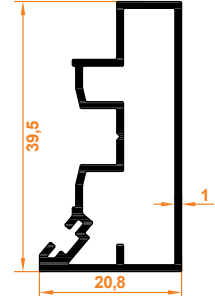

Yan Dikme Profil
Side Column Profile

Paket İçi Adet | 6
Quantity Per Package

809 0,328 kg/m

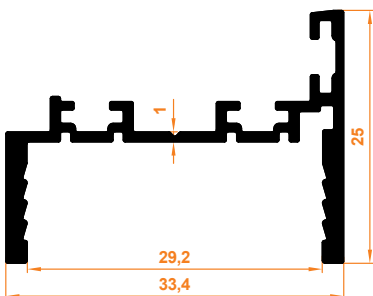

Sabit Cam Mentеше Profil
Stable Glass Hinge Profile

Paket İçi Adet | 6
Quantity Per Package

810 0,355 kg/m

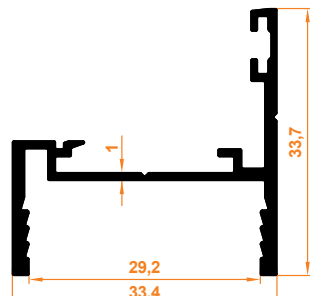

Sabit Cam Kilit Profil
Stable Glass Lock Profile

Paket İçi Adet | 6
Quantity Per Package

811 0,342 kg/m

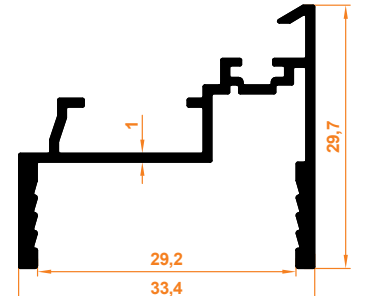

Sabit Cam Kilit Karşılığı Profil
Stable Glass Lock Prevention Profile

Paket İçi Adet | 6
Quantity Per Package

819

1,344 kg/m

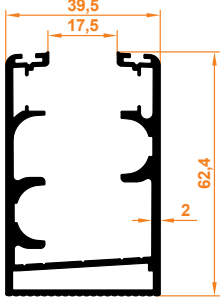

Düz Kasa Üstten Fitilli Profil
Flat Case Top Wicked Profile

Paket İçi Adet | 3
Quantity Per Package

820

1,389 kg/m

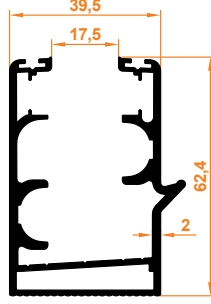

Oluklu Kasa Üstten Fitilli Profil
Corrugated Case Top Wicked Profile

Paket İçi Adet | 3
Quantity Per Package

822

0,378 kg/m

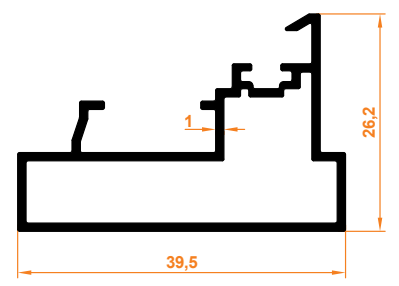

Açılır Dikme Profil
PopUp Column Profile

Paket İçi Adet | 6
Quantity Per Package

816

1,577 kg/m

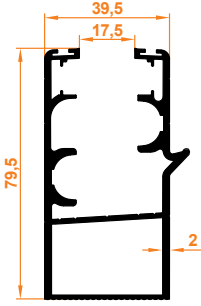

Üstten Fitilli Büyük Oluklu Kasa
Large Corrugated Case with Top Wick

Paket İçi Adet | 3
Quantity Per Package

817

1,532 kg/m

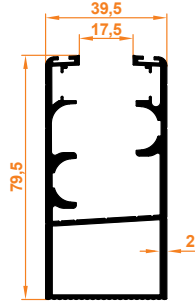

Üstten Fitilli Büyük Düz Kasa
Large Flat Case with Wed from Top

Paket İçi Adet | 3
Quantity Per Package

815

0,100 kg/m

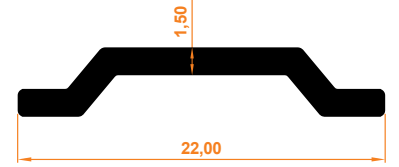

Tij Profil
Espagnolette Profile

Paket İçi Adet | 20
Quantity Per Package

823

0,459 kg/m

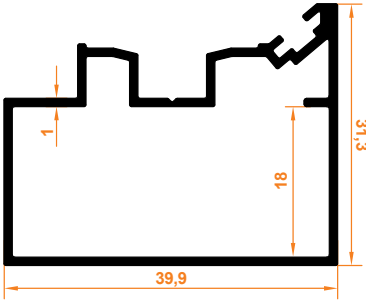

Geniş Yan Dikme
Wide Side Column

Paket İçi Adet | 6
Quantity Per Package

824

0,583 kg/m

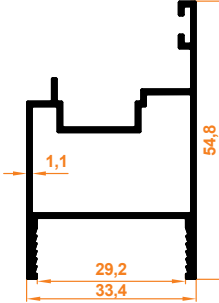

Sabit Cam İspanyolet Profil
Fixed Glass Espagnolette Profile

Paket İçi Adet | 6
Quantity Per Package

825

0,356 kg/m

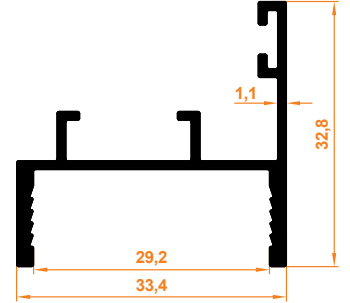

Sabit Cam İspanyolet Karşılık Profil
Fixed Glass Espagnolette Handle Provision Profile

Paket İçi Adet | 6
Quantity Per Package

830

0,680 kg/m

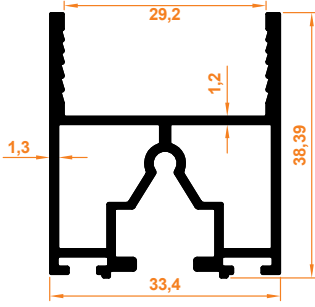

Fitilli Baza Profili
Wicked Base Profile

Paket İçi Adet | 6
Quantity Per Package

801

0,321 kg/m

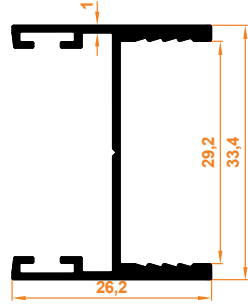

Düz Kapak Profili
Flat Cover Profile

Paket İçi Adet | 6
Quantity Per Package

802

0,327 kg/m

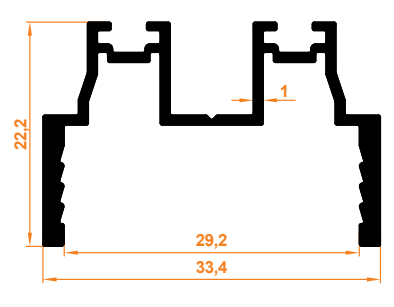

Düz Kapak Mantese Profili
Flat Cover with Hinge Profile

Paket İçi Adet | 6
Quantity Per Package

803

0,445 kg/m

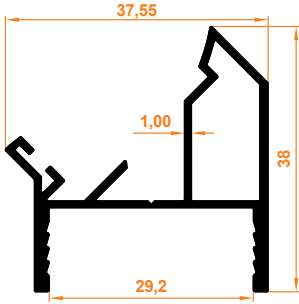

45° Dönüş Profili
45° Return Profile

Paket İçi Adet | 6
Quantity Per Package

804

0,378 kg/m

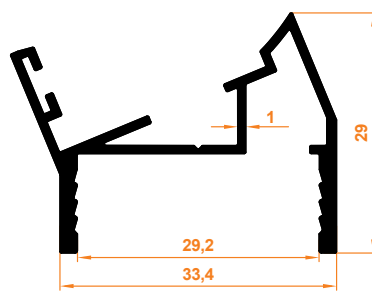

22,5° Dönüş Profili
22,5° Return Profile

Paket İçi Adet | 6
Quantity Per Package

805

0,366 kg/m

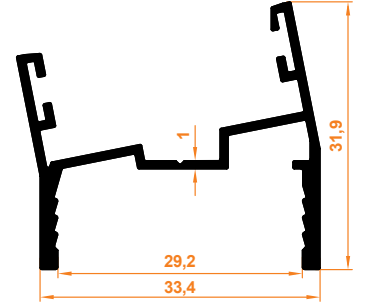

11° Dönüş Profili
11° Return Profile

Paket İçi Adet | 6
Quantity Per Package

806

0,475 kg/m

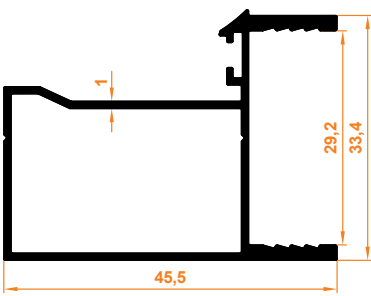

90° Dönüş Profili
90° Return Profile

Paket İçi Adet | 6
Quantity Per Package

807

0,346 kg/m

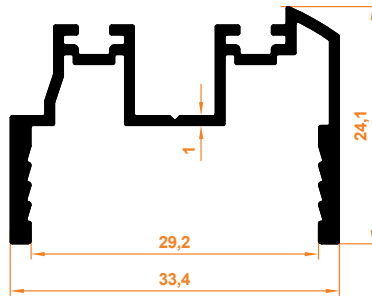

Açılı Dönüş Mantese Profili
PopUp Return Hinge Profile

Paket İçi Adet | 6
Quantity Per Package

808

0,369 kg/m

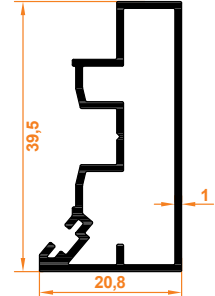

Yan Dikme Profili
Side Column Profile

Paket İçi Adet | 6
Quantity Per Package

809

0,328 kg/m

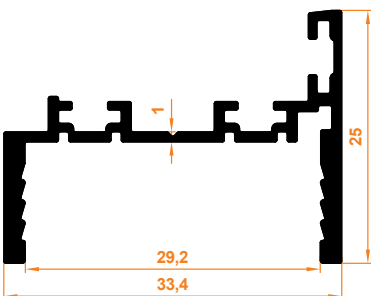

Sabit Cam Mantese Profili
Stable Glass Hinge Profile

Paket İçi Adet | 6
Quantity Per Package

810

0,355 kg/m

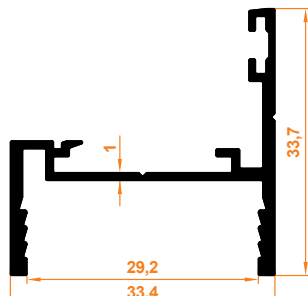

Sabit Cam Kilit Profili
Stable Glass Lock Profile

Paket İçi Adet | 6
Quantity Per Package

811

0,342 kg/m

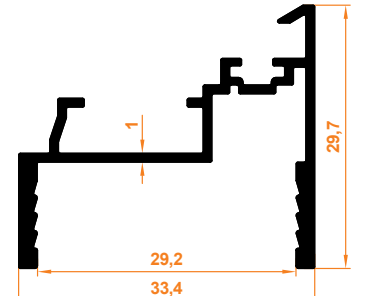

Sabit Cam Kilit Karşılığı Profili
Stable Glass Lock Prevention Profile

Paket İçi Adet | 6
Quantity Per Package

109

1,355 kg/m

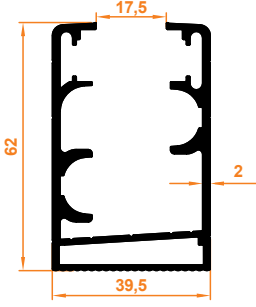

Düz Kasa Profil
Flat Case Profile

Paket İçi Adet
Quantity Per Package

3

110

1,396 kg/m

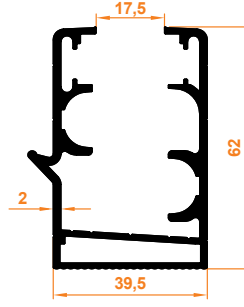

Oluklu Kasa Profil
Corrugated Case Profile

Paket İçi Adet
Quantity Per Package

3

822

0,378 kg/m

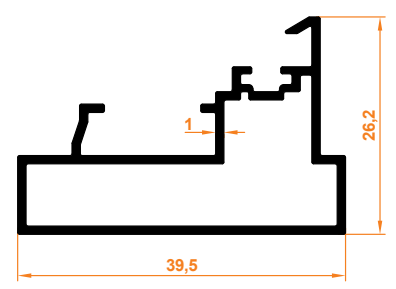

Açılır Dikme Profil
PopUp Column Profile

Paket İçi Adet
Quantity Per Package

6

106

1,611 kg/m

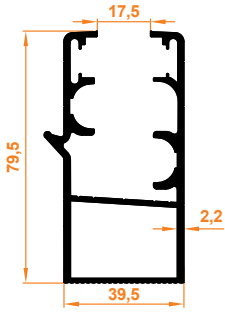

Oluklu Büyük Kasa Profil
Corrugated Big Case Profile

Paket İçi Adet
Quantity Per Package

3

107

1,570 kg/m

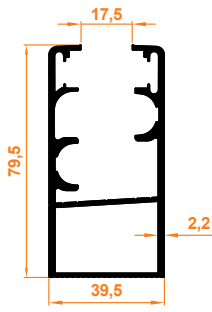

Büyük Düz Kasa Profil
Big Flat Case Profile

Paket İçi Adet
Quantity Per Package

3

823

0,459 kg/m

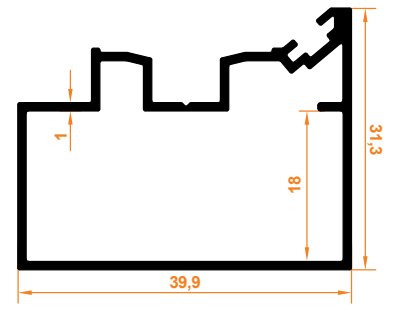

Geniş Yan Dikme
Wide Side Column

Paket İçi Adet
Quantity Per Package

6

824

0,583 kg/m

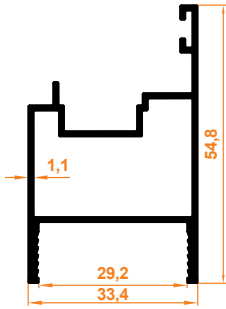

Sabit Cam İspanyolet Profil
Fixed Glass Espagnolette Profile

Paket İçi Adet
Quantity Per Package

6

825

0,356 kg/m

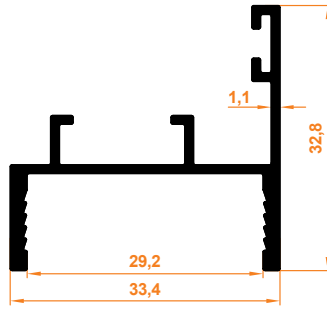

Sabit Cam İspanyolet Karşılık Profil
Fixed Glass Espagnolette Handle Provision Profile

Paket İçi Adet
Quantity Per Package

6

210

0,643 kg/m

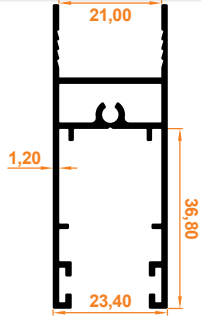

Sürme Baza Profil
Sliding Base Profile

Paket İçi Adet
Quantity Per Package

5

215

0,908 kg/m

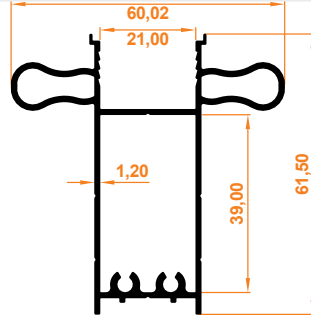

Çekme Køl Profil
Pull Handle Profile

Paket İçi Adet
Quantity Per Package

3

212

0,423 kg/m

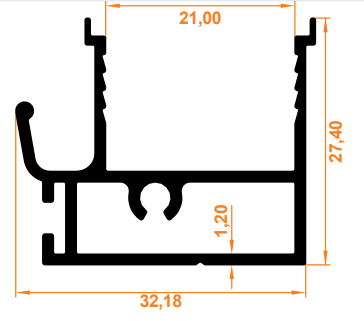

Kenet Profil
Clamp Profile

Paket İçi Adet
Quantity Per Package

6

211

0,301 kg/m

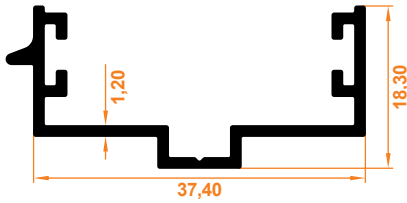

Birleřtirme Karřılık Profil
Combination Provisions Profile

Paket İçi Adet
Quantity Per Package

6

213

0,974 kg/m

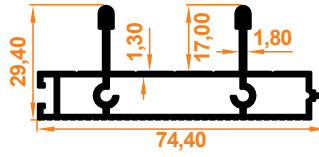

İkili Eřikli Alt Kasa Profil
Double Threshold Lower Case Profile

Paket İçi Adet
Quantity Per Package

4

222

1,333 kg/m

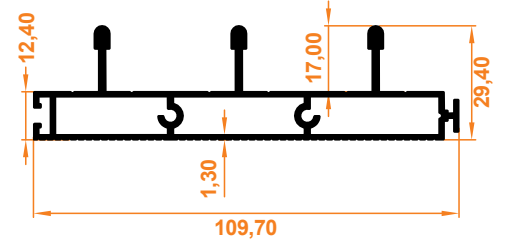

Üçlü Eřikli Alt Kasa Profil
Triple Threshold Lower Case Profile

Paket İçi Adet
Quantity Per Package

2

220

0,867 kg/m

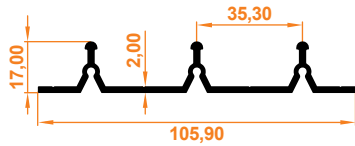

Üçlü Eřiksiz Alt Kasa Profil
Triple Bottom Case Profile without Threshold

Paket İçi Adet
Quantity Per Package

4

229

1,120 kg/m

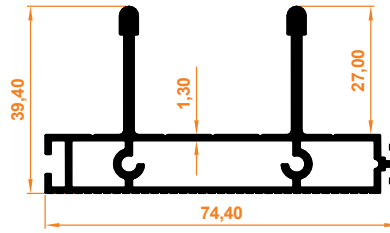

İkili Üst Kasa Profil
Double Upper Case Profile

Paket İçi Adet
Quantity Per Package

2

230

1,552 kg/m

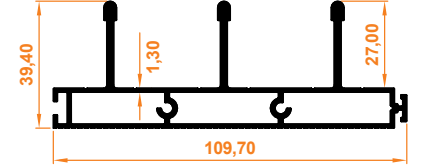

İkili Üçlü Kasa Profil
Triple Upper Case Profile

Paket İçi Adet
Quantity Per Package

2

221

1,156 kg/m

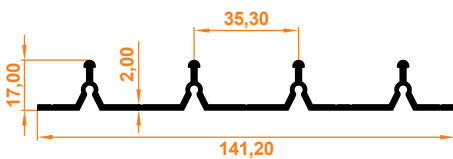

Dörtlü Eřiksiz Alt Kasa Profil
Quadruple Bottom Case Profile without Threshold

Paket İçi Adet
Quantity Per Package

2

214

0,587 kg/m

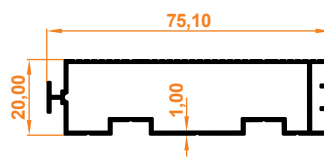

İkili Yan Kasa Profil
Double Side Case Profile

Paket İçi Adet
Quantity Per Package

4

223

0,792 kg/m

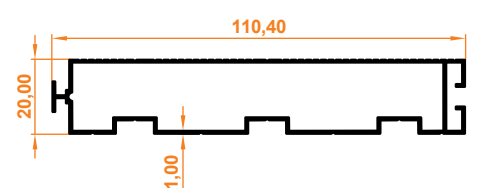

Üçlü Yan Kasa Profil
Triple Side Case Profile

Paket İçi Adet
Quantity Per Package

2

219

0,219 kg/m

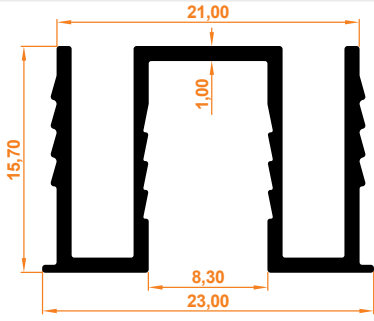

8 mm Cam Adaptörü
8mm Glass Adapter

Paket İçi Adet
Quantity Per Package

10

226

0,071 kg/m

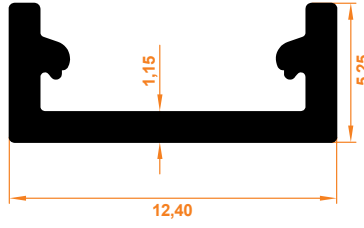

Kapatma Profil
Closing Profile

Paket İçi Adet
Quantity Per Package

20

227

0,751 kg/m

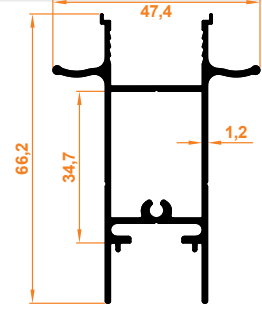

İspanyolet Çekme Kollu Profil
Espagnolette Pull Handle Profile

Paket İçi Adet
Quantity Per Package

3

228

0,156 kg/m

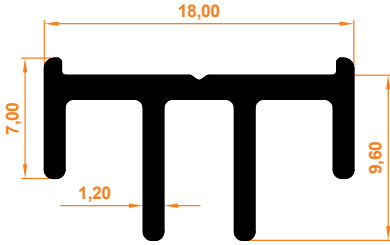

İspanyolet Karşılık Profil
Espagnolette Provision Profile

Paket İçi Adet
Quantity Per Package

10

Sürme Sistem Çalışma Mekanizması

Sliding System Operating Mechanism

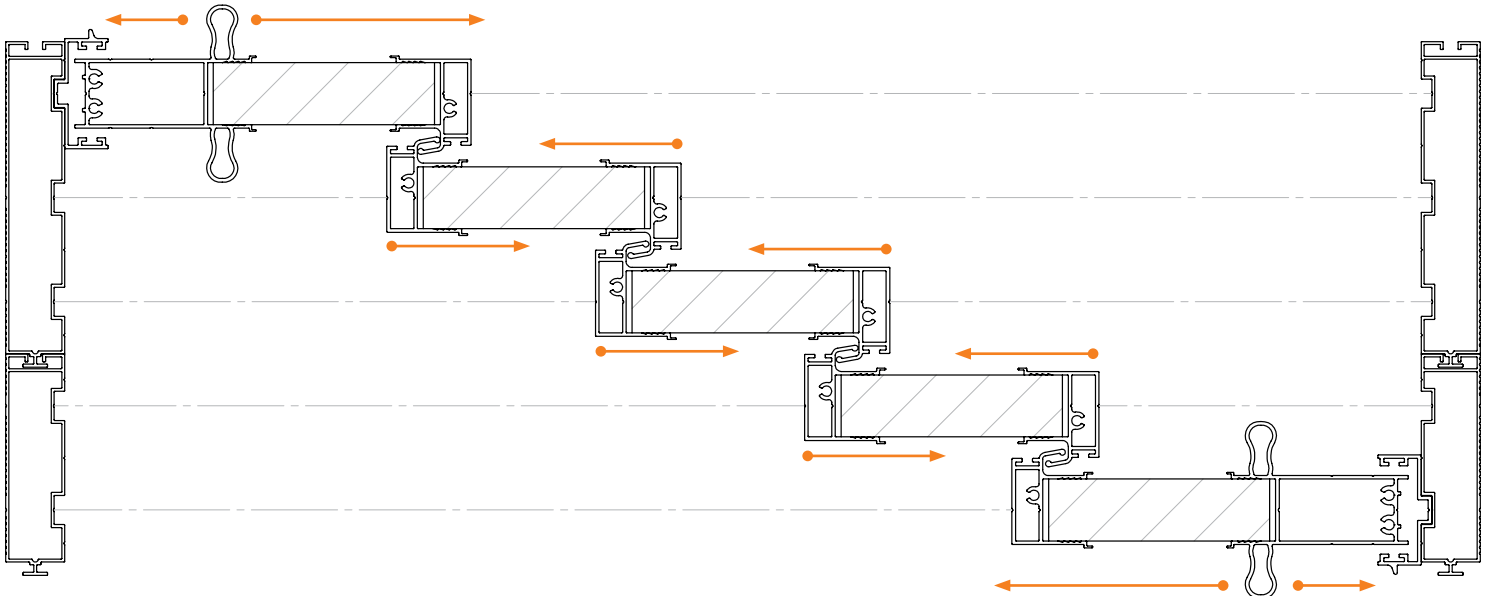

Sürme Sistem Çalışma Mekanizması

Sliding System Operating Mechanism

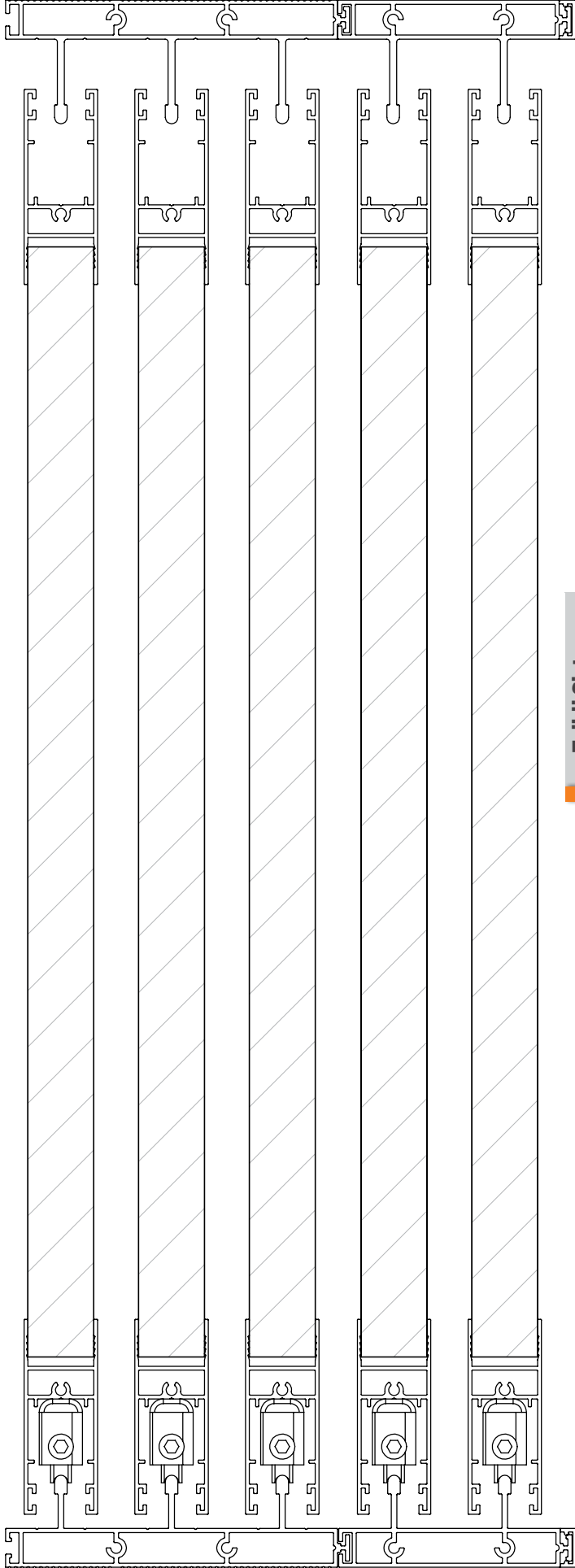

Eşikli Sistem
System with Threshold

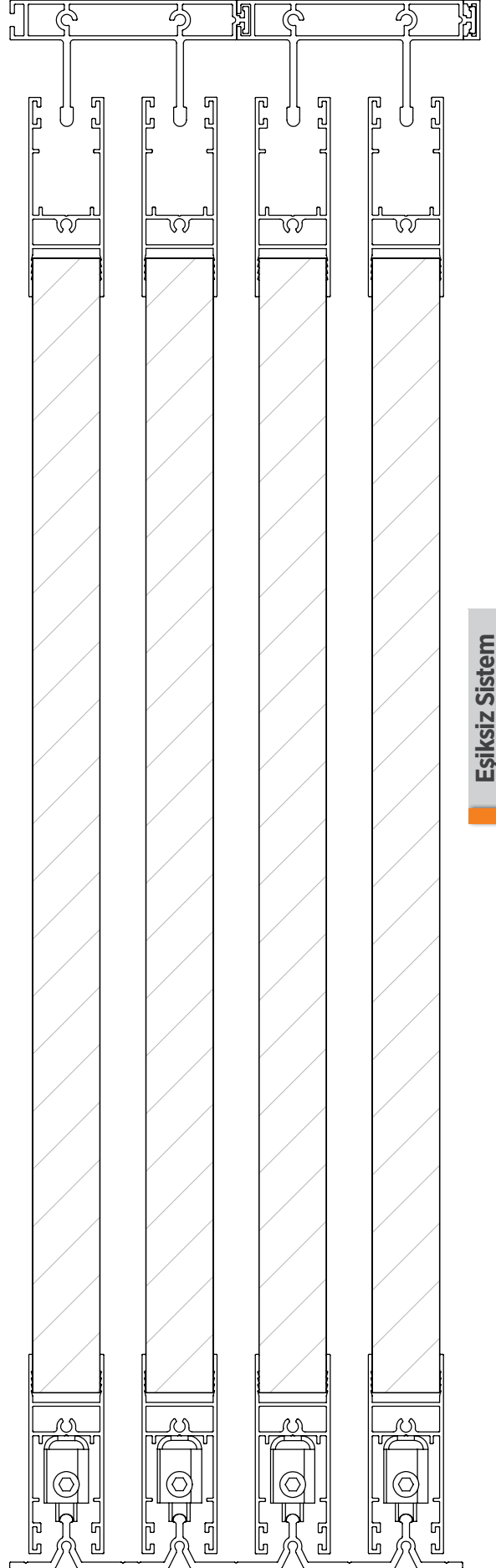

Eşiksiz Sistem
System without Threshold

140

0,563 kg/m

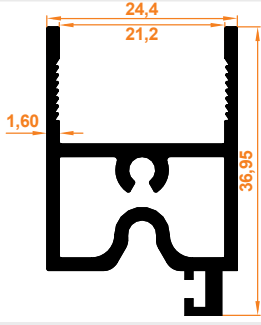

Sabit Panel Açılır Alt Baza Profil
Fixed Panel Pop-up Base Profile

Paket İçi Adet
Quantity Per Package

6

164

0,842 kg/m

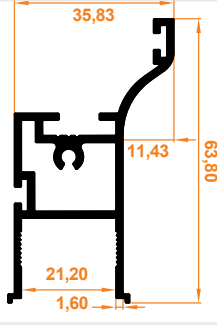

Sabit Panel Yan Dikme Profil
Fixed Panel Side Column Profile

Paket İçi Adet
Quantity Per Package

4

142

0,750 kg/m

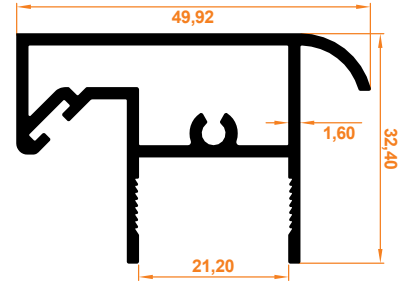

Sabit Panel Üst Baza Profil
Fixed Panel Top Base Profile

Paket İçi Adet
Quantity Per Package

4

167

1,144 kg/m

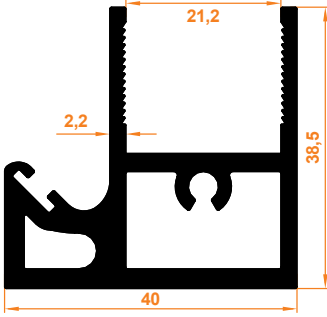

Kenet Baza Profil
Clamp Base Profile

Paket İçi Adet
Quantity Per Package

4

144

0,434 kg/m

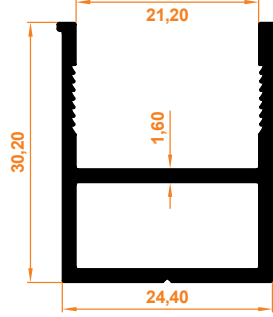

Hareketli Panel Yan Dikme Profil
Movable Panel Side Column Profile

Paket İçi Adet
Quantity Per Package

6

145

0,579 kg/m

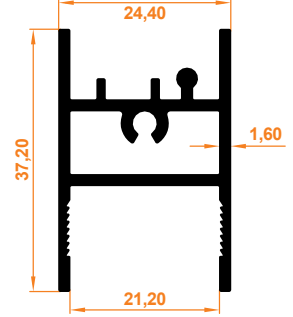

Küpeşte Baza Profil
Handrail Base Profile

Paket İçi Adet
Quantity Per Package

6

146

0,741 kg/m

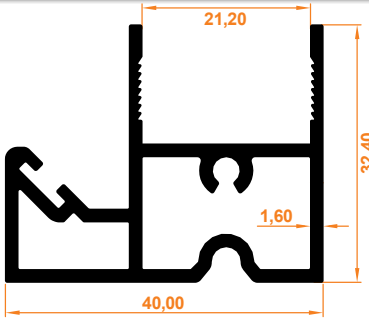

Hareketli Panel Açılır Alt Baza Profil
Movable Panel Pop-up Lower Base Profile

Paket İçi Adet
Quantity Per Package

4

161

0,482 kg/m

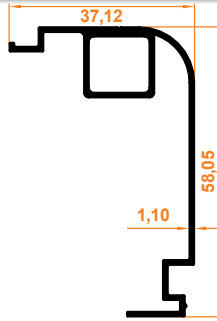

Ray Kapatma "T" Profil
Rail Closure "T" Profile

Paket İçi Adet
Quantity Per Package

4

160

1,057 kg/m

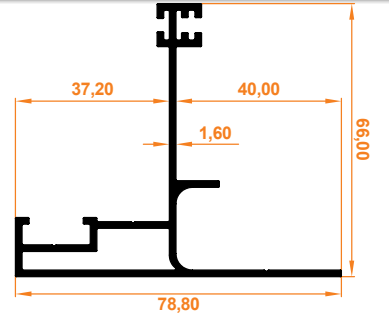

Yan Ray "T" Profil
Side Rail "T" Profile

Paket İçi Adet
Quantity Per Package

2

166

0,144 kg/m

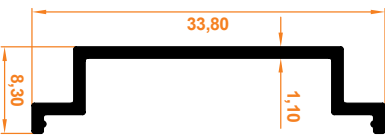

Açılımlı için Ray Kapatma "L" Profil
Rail Closure "L" Profile for Opening

Paket İçi Adet
Quantity Per Package

10

162

0,703 kg/m

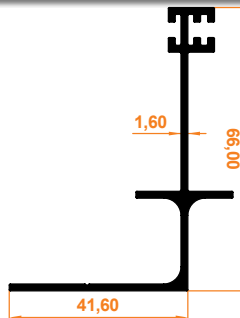

Yan Ray "L" Profil
Side Rail "L" Profile

Paket İçi Adet
Quantity Per Package

4

GYT 28

2,110 kg/m

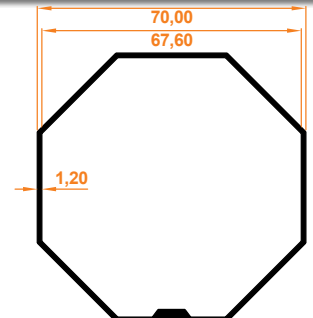

Sac Tambur Borusu
Sheet Drum Pipe

Paket İçi Adet
Quantity Per Package

1

152

1,563 kg/m

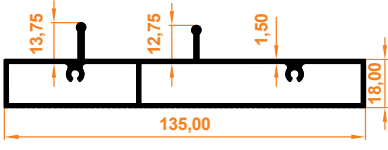

Alt Kasa
Guillotine Lower Case Profile

Paket İçi Adet | 2
Quantity Per Package

156

3,449 kg/m

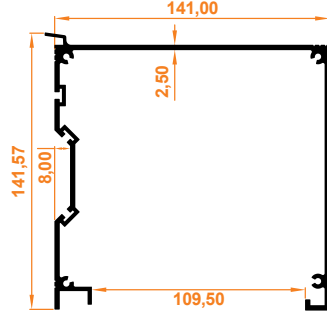

Üst Kasa Profil
Top Case Profile

Paket İçi Adet | 1
Quantity Per Package

153

0,864 kg/m



Üst Kasa Kapak Profil
Top Case Cover Profile

Paket İçi Adet | 2
Quantity Per Package

155

1,669 kg/m

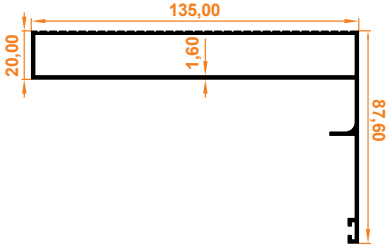

Yan Kasa Profil
Side Case Profile

Paket İçi Adet | 2
Quantity Per Package

154

0,759 kg/m

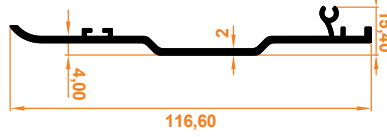

Küpeste Profil
Handrail Profile

Paket İçi Adet | 2
Quantity Per Package

165

0,644 kg/m



Yan Kasa Kertme Profil
Side Case Notched Profile

Paket İçi Adet | 4
Quantity Per Package

158

0,510 kg/m

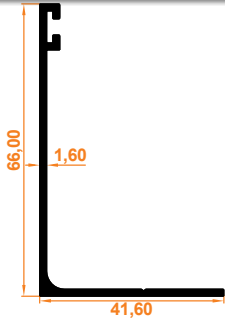

Açılımsız Tek Fıtil Yan Ray L Kasa Profil
Single Weatherstrips Without Opening Side L Case Profile

Paket İçi Adet | 4
Quantity Per Package

159

0,660 kg/m

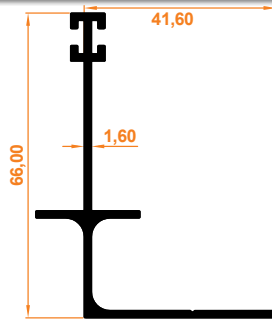

Açılımsız Çift Fıtil Yan Ray L Kasa Profil
Double Weatherstrips Without Opening Side L Case Profile

Paket İçi Adet | 4
Quantity Per Package

219

0,219 kg/m

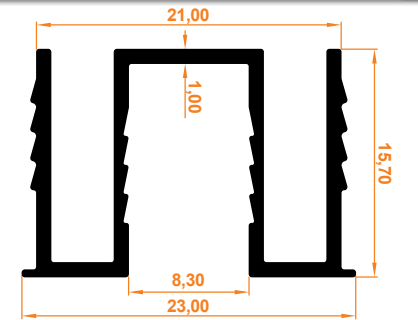

8 mm Cam Adaptörü
8mm Glass Adapter

Paket İçi Adet | 10
Quantity Per Package

149

0,162 kg/m

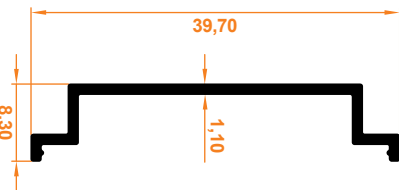

Açılımsız için Ray Kapatma 'L' Profil
Rail Closure 'L' Profile for Non-Opening

Paket İçi Adet | 10
Quantity Per Package

Giyyotin Sistem Çalışma Mekanizması

Guillotine System Operating Mechanism

1. Kademe - Level 1

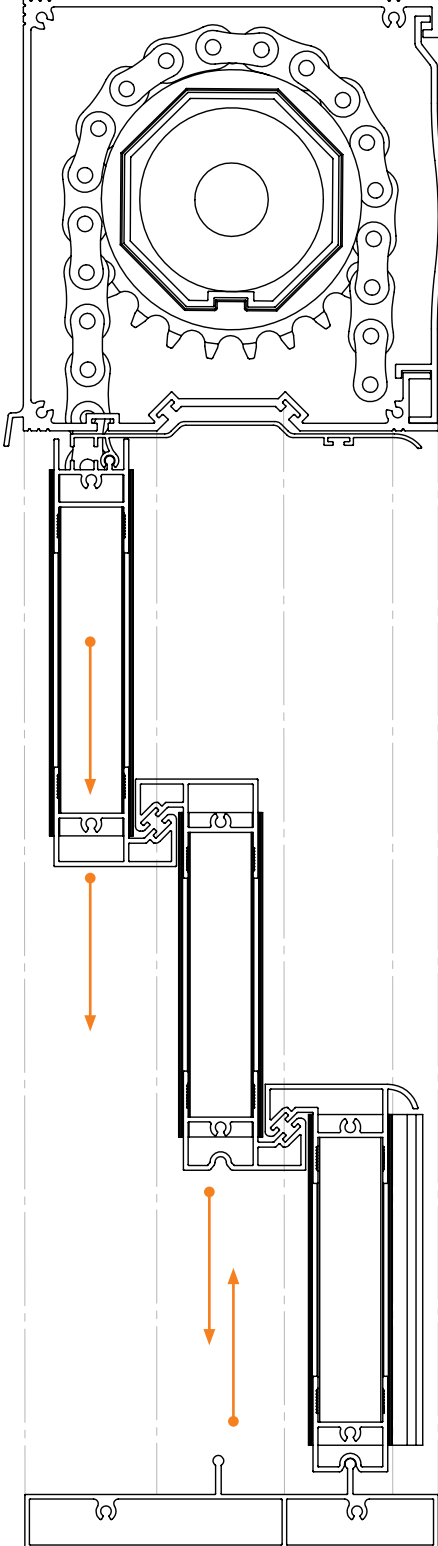

2. Kademe - Level 2

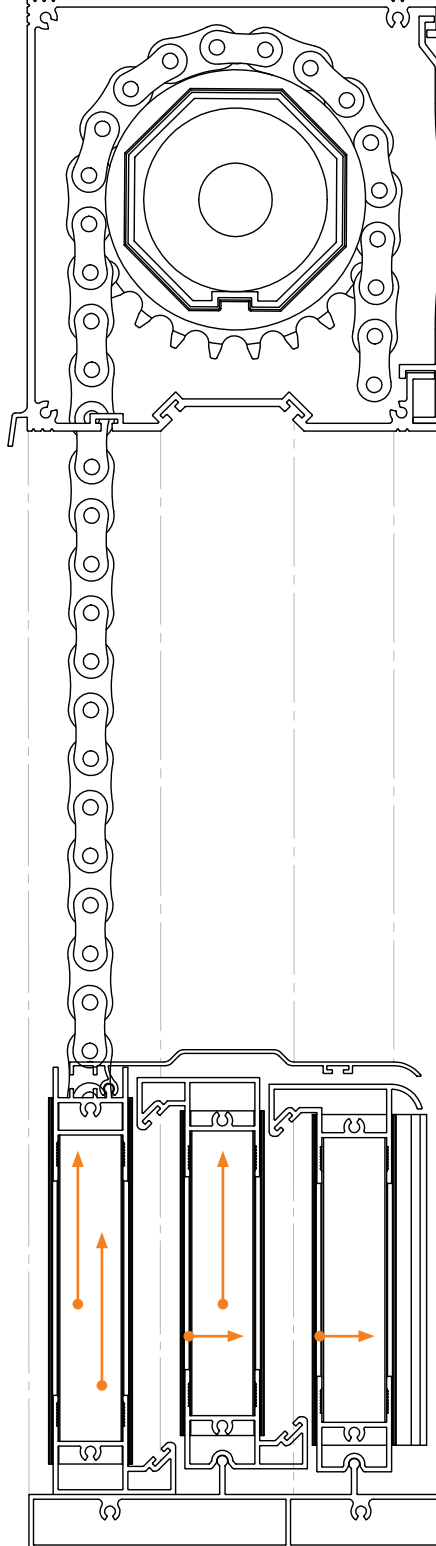

3. Kademe - Level 3

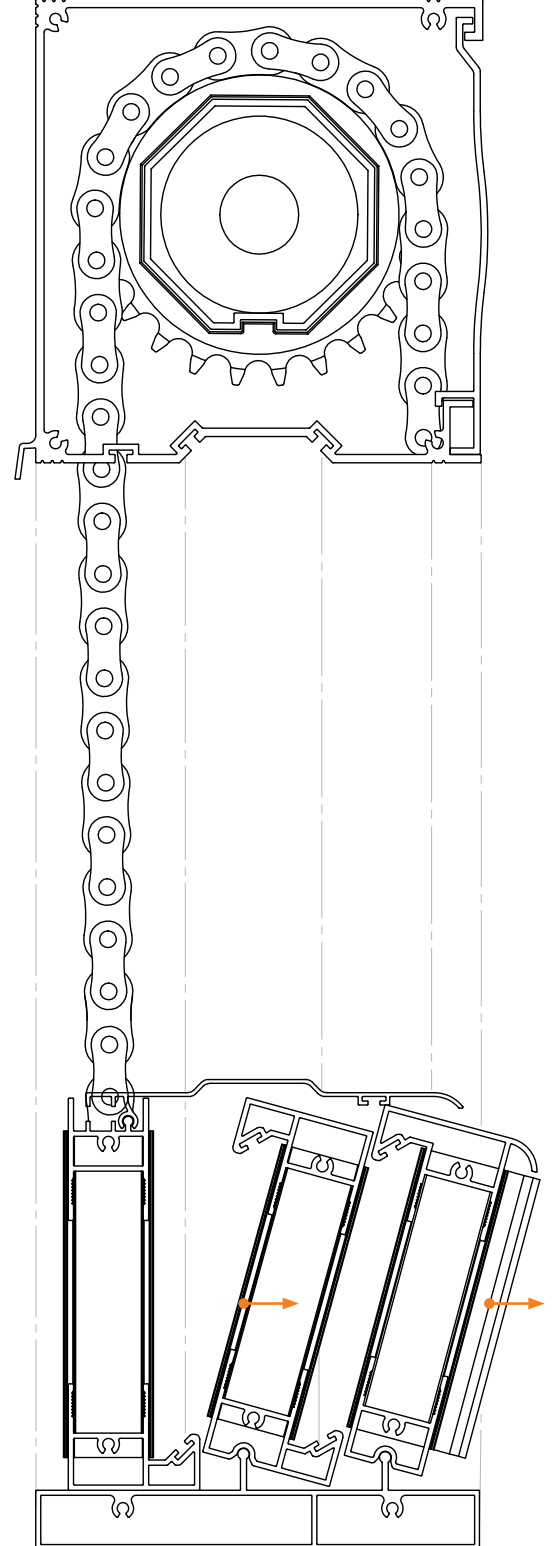

417

0,467 kg/m

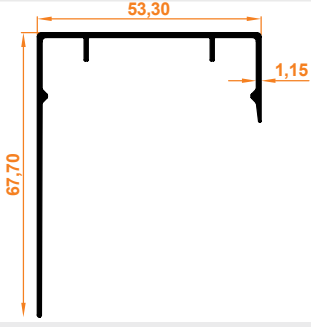

Sonlandırıcı Cam Çıta Kapak Profili
End Cap Glass Strip Cover Profile

Paket İçi Adet
Quantity Per Package

4

418

0,329 kg/m

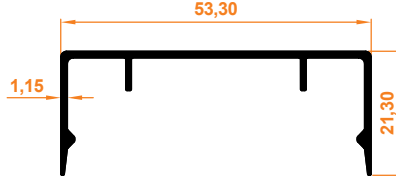

Cam Çıta Kapak Profili
Glass Strip Cover Profile

Paket İçi Adet
Quantity Per Package

10

419

2,100 kg/m

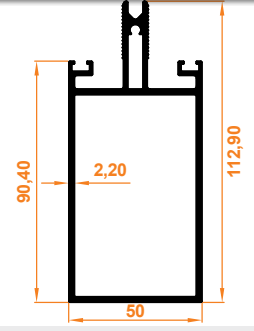

Orta Kayıt Profili
Center Mullion Profile

Paket İçi Adet
Quantity Per Package

2

420

0,682 kg/m

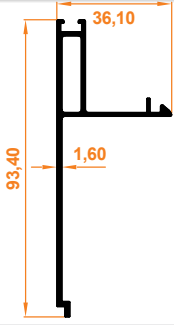

Kasa Kapatma Profili
Frame Closure Profile

Paket İçi Adet
Quantity Per Package

2

421

3,184 kg/m

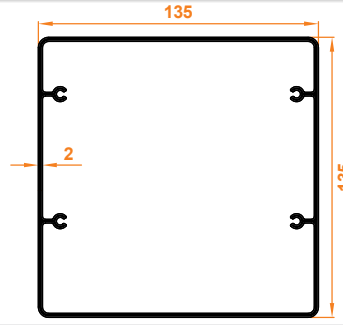

Ayak Profili
Leg Profile

Paket İçi Adet
Quantity Per Package

1

422

4,318 kg/m

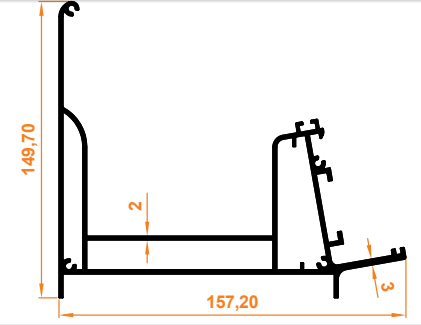

Oluk Profili
Groove Profile

Paket İçi Adet
Quantity Per Package

1

423

3,142 kg/m

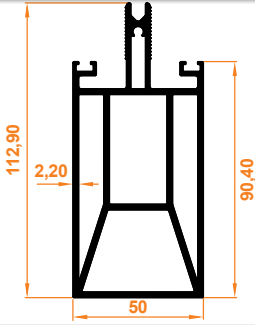

Destekli Orta Kayıt Profili
Reinforced Center Mullion Profile

Paket İçi Adet
Quantity Per Package

2

424

2,835 kg/m

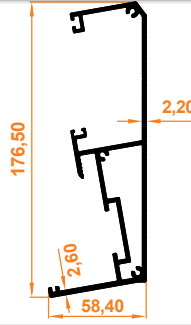

Duvar Kasa Profili
Wall Frame Profile

Paket İçi Adet
Quantity Per Package

1

426

3,434 kg/m

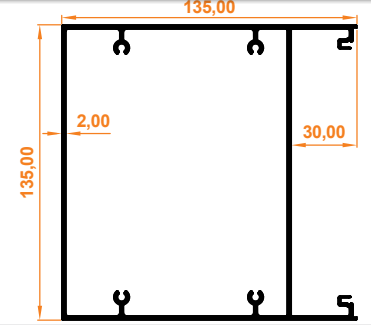

Gizli Ayak Profili
Hidden Leg Profile

Paket İçi Adet
Quantity Per Package

1

427

2,271 kg/m

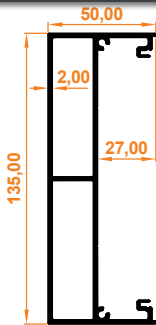

Destek Kutu Profili
Reinforcing Box Profile

Paket İçi Adet
Quantity Per Package

2

428

0,501 kg/m

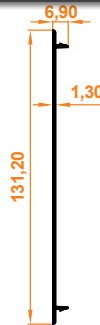

Gizli Ayak ve Destek Kutu Kapatma Profili
Hidden Leg Case Cover Support Profile

Paket İçi Adet
Quantity Per Package

10

429

0,578 kg/m

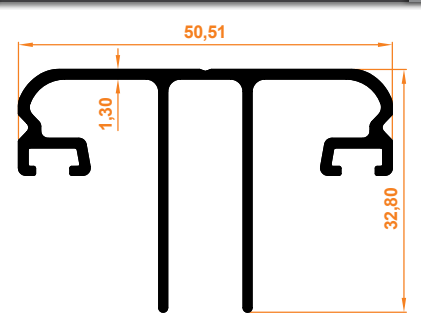

Cam Çıta Profili
Glass Strip Profile

Paket İçi Adet
Quantity Per Package

2

430

2,252 kg/m

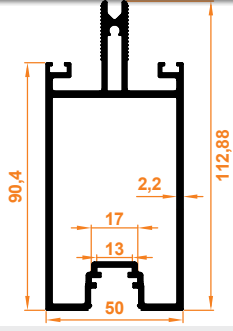

431

0,079 kg/m

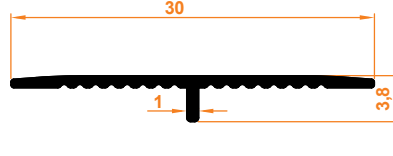

Ledli Orta Kayıt Profili

Center Mullion Profile with Led

Paket İçi Adet
Quantity Per Package

2

T Profili

T Profile

Paket İçi Adet
Quantity Per Package

10

7100 0,921 kg/m

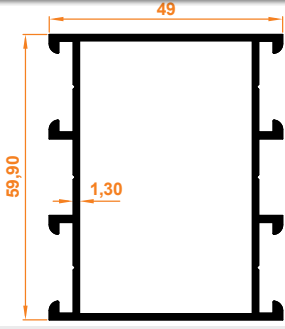

C60 Kasa Orta Kayıt Profili
C60 Case Mid Entry Profile

Paket İçi Adet | 4
Quantity Per Package

7101 0,988 kg/m

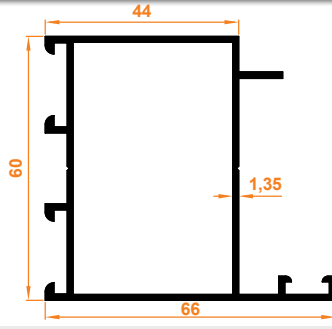

C60 Kanat Profili
C60 Wing Profile

Paket İçi Adet | 4
Quantity Per Package

7102 1,440 kg/m

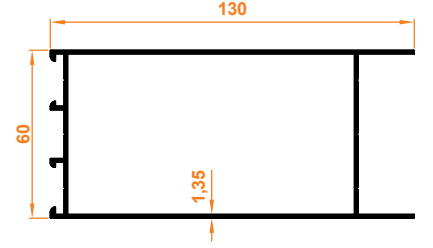

C60 Etek Profili
C60 Skirt Profile

Paket İçi Adet | 2
Quantity Per Package

7103 1,099 kg/m

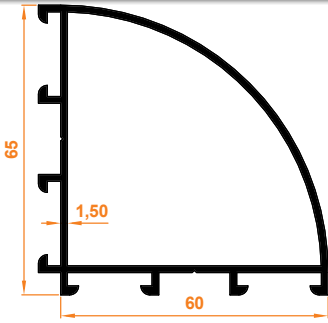

C60 Oval Köşe Dönüş Profili
C60 Oval Corner Profile

Paket İçi Adet | 2
Quantity Per Package

7104 0,436 kg/m

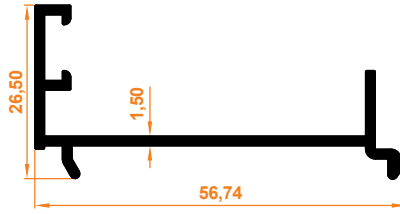

C60 Kanat Adaptörü Profili
C60 Wing Adapter Profile

Paket İçi Adet | 8
Quantity Per Package

7105 1,155 kg/m

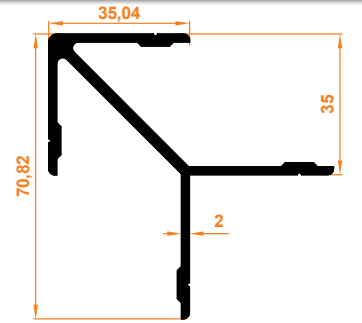

C60 Köşe Takozu
C60 Corner Wedge

Paket İçi Adet | 3
Quantity Per Package

7106 0,467 kg/m

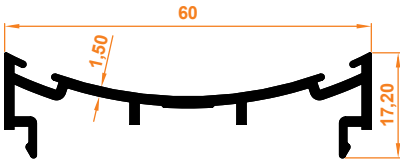

C60 Çarpma Kapı Adaptörü - Dişi
C60 Crash Door Adapter - Female

Paket İçi Adet | 8
Quantity Per Package

7107 0,367 kg/m

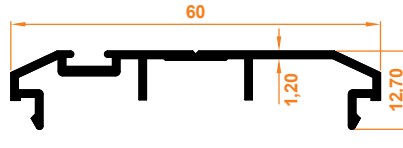

C60 Çarpma Kapı Adaptörü - Erkek
C60 Crash Door Adapter - Male

Paket İçi Adet | 8
Quantity Per Package

7108 0,241 kg/m

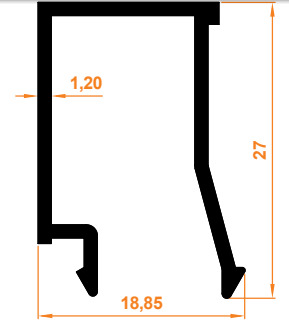

C60 Isıcam Çıta Profili
C60 Insulating Glass Stave Profile

Paket İçi Adet | 24
Quantity Per Package

7109 0,234 kg/m

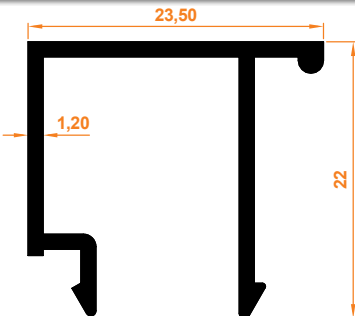

C60 Tek Cam Çıta Profili
C60 Single Glass Stave Profile

Paket İçi Adet | 24
Quantity Per Package

7000

0,473 kg/m

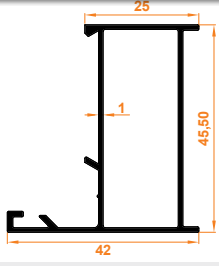

Aldoks (Dar) Kasa Profili
Aldoks (Tight) Frame Profile

Paket İçi Adet
Quantity Per Package

6

7001

0,565 kg/m

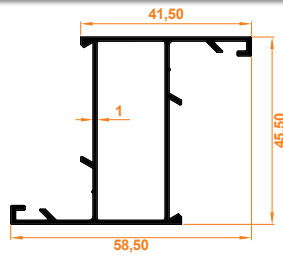

Aldoks (Dar) Kanat Profili
Aldoks (Tight) Wing Profile

Paket İçi Adet
Quantity Per Package

4

7002

0,565 kg/m

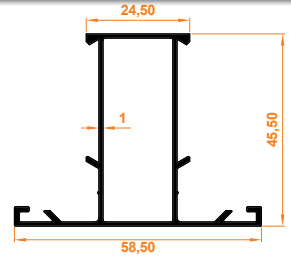

Aldoks (Dar) Orta Kayıt Profili
Aldoks (Tight) Mid Entry Profile

Paket İçi Adet
Quantity Per Package

4

7003

0,891 kg/m

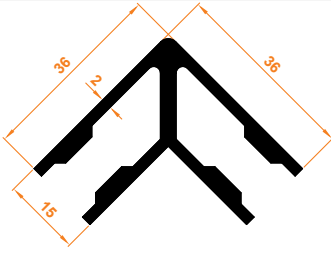

Aldoks (Dar) Köşe Takozu
Aldoks (Tight) Corner Wedge

Paket İçi Adet
Quantity Per Package

3

7004

0,565 kg/m

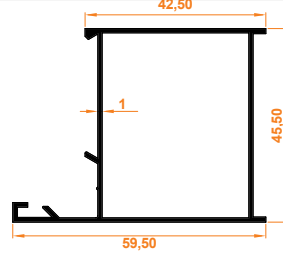

Aldoks (Orta) Kasa Profili
Aldoks (Mid) Frame Profile

Paket İçi Adet
Quantity Per Package

6

7005

0,659 kg/m

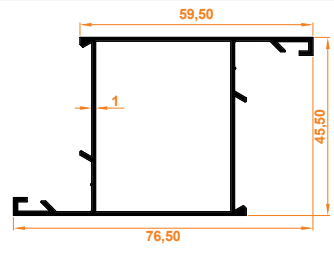

Aldoks (Orta) Kanat Profili
Aldoks (Mid) Wing Profile

Paket İçi Adet
Quantity Per Package

3

7006

0,659 kg/m

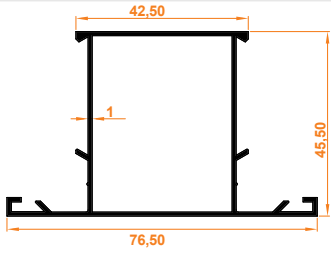

Aldoks (Orta) Kayıt Profili
Aldoks (Mid) Entry Profile

Paket İçi Adet
Quantity Per Package

3

7007

1,136 kg/m

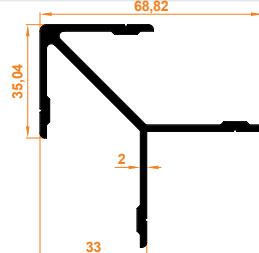

Aldoks (Orta) Köşe Takozu
Aldoks (Mid) Corner Wedge

Paket İçi Adet
Quantity Per Package

3

7008

0,695 kg/m

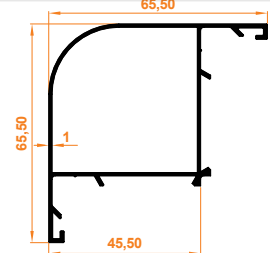

Aldoks Oval Köşe Dönüş Profili
Aldoks Oval Corner Profile

Paket İçi Adet
Quantity Per Package

2

7009

0,719 kg/m

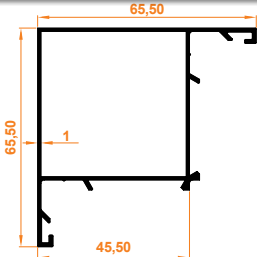

Aldoks Köşe Dönüş Profili
Aldoks Corner Profile

Paket İçi Adet
Quantity Per Package

2

7010

1,028 kg/m

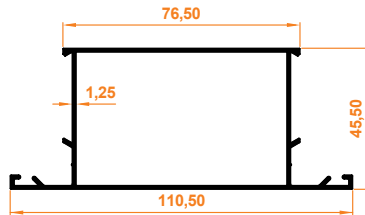

Aldoks (Geniş) Orta Kayıt Profili
Aldoks (Wide) Mid Entry Profile

Paket İçi Adet
Quantity Per Package

2

7011

1,028 kg/m

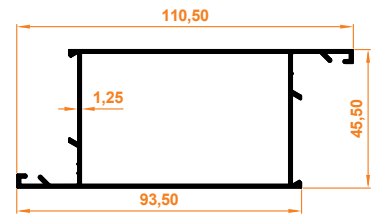

Aldoks (Geniş) Kanat Profili
Aldoks (Wide) Wing Profile

Paket İçi Adet
Quantity Per Package

2

7012

1,149 kg/m

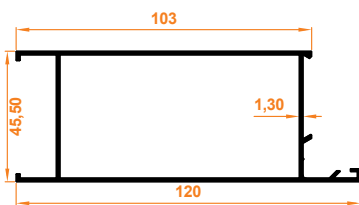

Aldoks Etek Profili
Aldoks Skirt Profile

Paket İçi Adet
Quantity Per Package

2

7013

0,215 kg/m

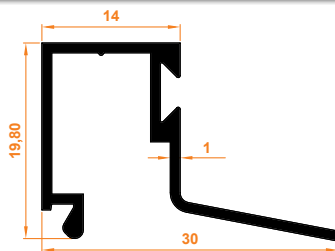

Aldoks Isıcam Çita
Aldoks Double Glazing Stave

Paket İçi Adet
Quantity Per Package

10

7014

0,213 kg/m

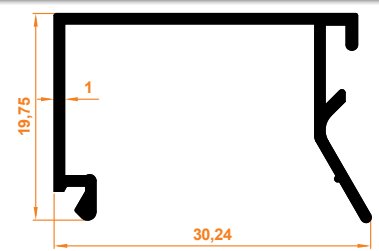

Aldoks Tek Cam Çita
Aldoks Single Glass Stave

Paket İçi Adet
Quantity Per Package

16

900

0,685 kg/m

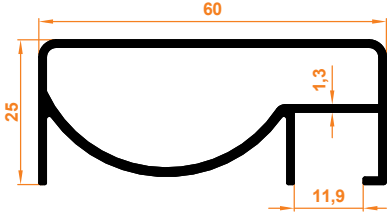

60x25 mm Üst Küpeşte Yandan Kanallı
60x25 mm Upper Handrail with Side Channel

Paket İçi Adet
Quantity Per Package

4

901

0,230 kg/m

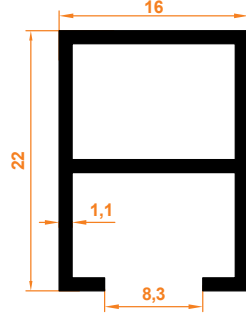

Cam Tutucu
Glass Holder

Paket İçi Adet
Quantity Per Package

10

902

0,848 kg/m

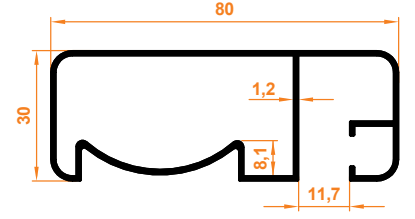

80x30 Yandan Kanallı
80x30 Side Channel

Paket İçi Adet
Quantity Per Package

4

903

0,785 kg/m

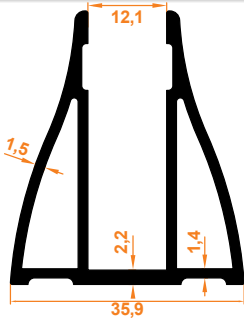

Cam Alt Baza
Glass Bottom Base

Paket İçi Adet
Quantity Per Package

3

904

0,159 kg/m

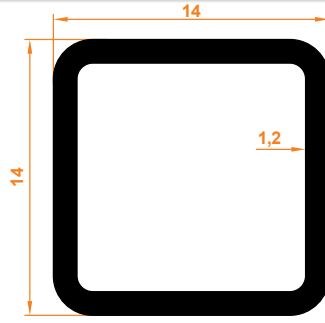

14x14 Emniyet Şeridi
14x14 Safety Strip

Paket İçi Adet
Quantity Per Package

20

905

0,060 kg/m

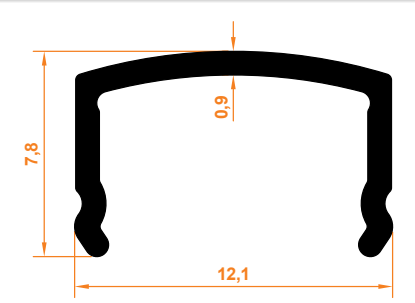

Boru Çıtası
Pipe Lath

Paket İçi Adet
Quantity Per Package

20

906

0,650 kg/m

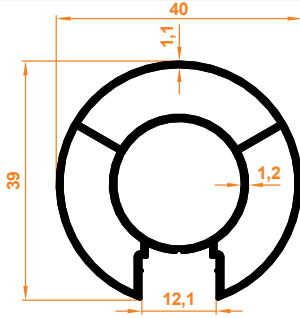

40x1,1 mm Tek Kanallı Çiftli Dikme
40x1,1 mm Single Channel Double Column

Paket İçi Adet
Quantity Per Package

5

907

0,532 kg/m

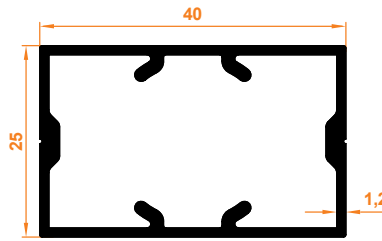

40x25 Dikme
40x25 Column

Paket İçi Adet
Quantity Per Package

10

908

0,922 kg/m

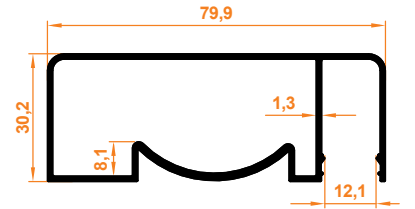

80x30 Yandan Kanallı
80x30 Side Channel

Paket İçi Adet
Quantity Per Package

4

909

0,717 kg/m

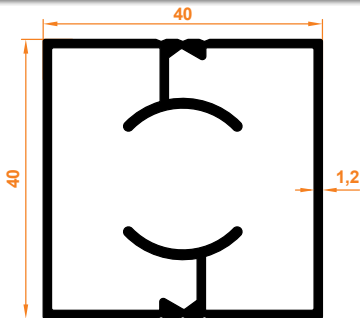

40x40 Kanalsız Dikme
40x40 Non Channel Column

Paket İçi Adet
Quantity Per Package

3

910

0,631 kg/m

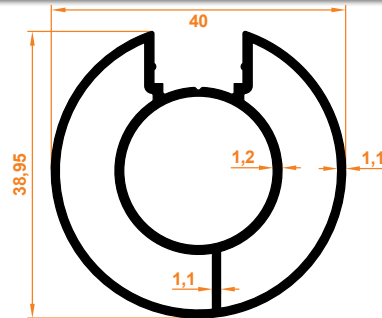

40x1,1 mm Tek Kanallı Tekli Dikme
40x1,1 mm Single Channel Single Column

Paket İçi Adet
Quantity Per Package

5

911

0,840 kg/m

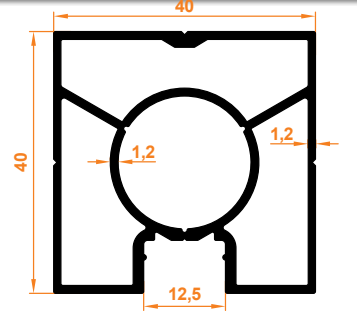

40x40 Tek Kanallı Dikme
40x40 Single Channel Column

Paket İçi Adet
Quantity Per Package

3

912

0,641 kg/m

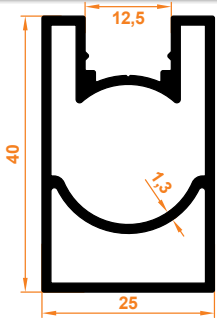

40x25 Tek Kanallı
40x25 Single Slot

Paket İçi Adet
Quantity Per Package

10

913

0,064 kg/m

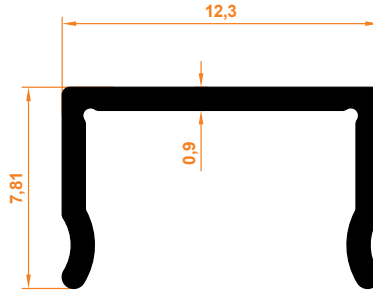

Kare Çıta
Square Slot

Paket İçi Adet
Quantity Per Package

20

914

0,082 kg/m

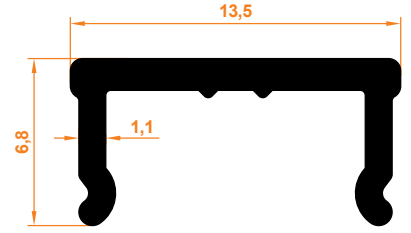

80x30 Yandan Kanallı Çıtası
80x30 Side Slot Rail

Paket İçi Adet
Quantity Per Package

20

915

0,778 kg/m

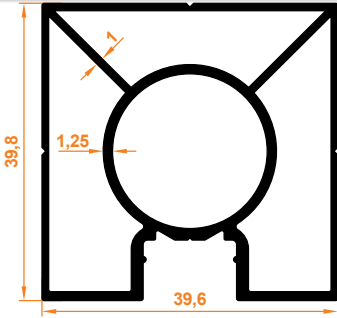

40x40 Tek Kanallı Dikme
40x40 Single Slot Column

Paket İçi Adet
Quantity Per Package

3

916

0,627 kg/m

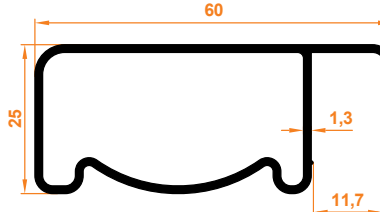

60x25 Yandan Kanallı
60x25 Side Slot

Paket İçi Adet
Quantity Per Package

4

918

0,256 kg/m

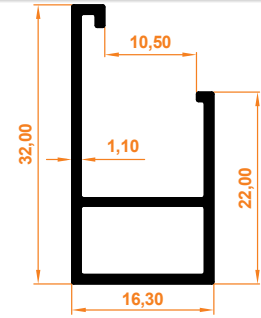

8-10 mm Cam Altı Profil
8-10 mm Glass Bottom

Paket İçi Adet
Quantity Per Package

10

919

0,807 kg/m

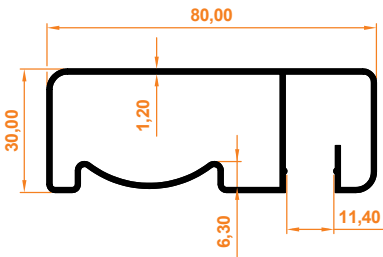

80x30 Yandan Kanallı
80x30 Side Slot

Paket İçi Adet
Quantity Per Package

4

923

0,326 kg/m

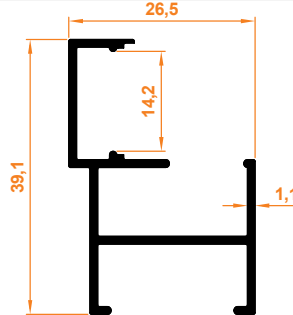

Cam Tutucu Profil
Glass Holder Profile

Paket İçi Adet
Quantity Per Package

10

924

0,082 kg/m

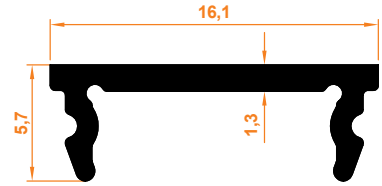

Takviyesiz Cam Tutucu Çıta Profil
Non-Reinforced Glass Holder Lath Profile

Paket İçi Adet
Quantity Per Package

20

925

0,396 kg/m

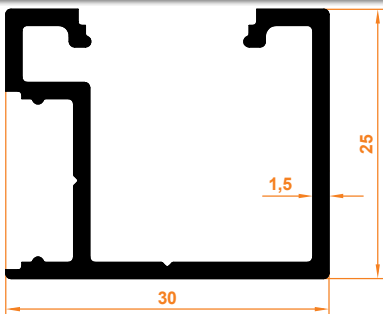

Takviyesiz Cam Tutucu Profil
Non-Reinforced Glass Holder Profile

Paket İçi Adet
Quantity Per Package

6

926

0,501 kg/m

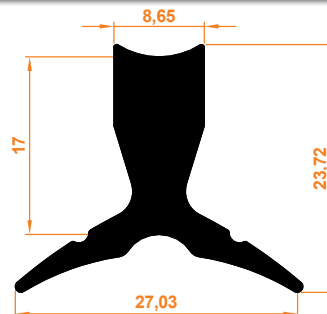

Y Bağlantı Profil
Y-Connector Profile

Paket İçi Adet
Quantity Per Package

8

927

0,478 kg/m

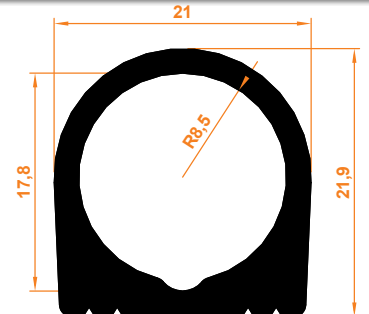

Boru Tutamak Profil
Tube Grip Profile

Paket İçi Adet
Quantity Per Package

8

700

0,185 kg/m

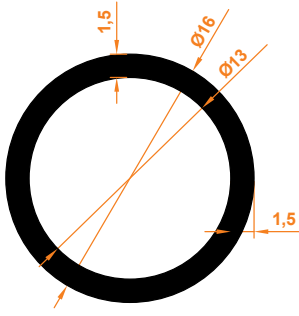

16x1,5 Boru
16x1,5 Pipe

Paket İçi Adet
Quantity Per Package

12

701

0,538 kg/m

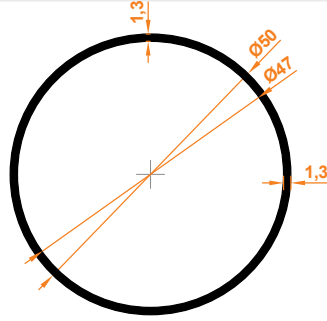

50x1,3 Boru
50x1,3 Pipe

Paket İçi Adet
Quantity Per Package

3

702

0,509 kg/m

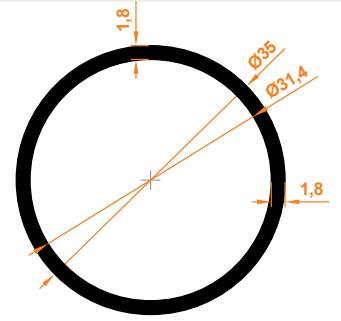

35x1,8 Boru
35x1,8 Pipe

Paket İçi Adet
Quantity Per Package

5

703

0,182 kg/m

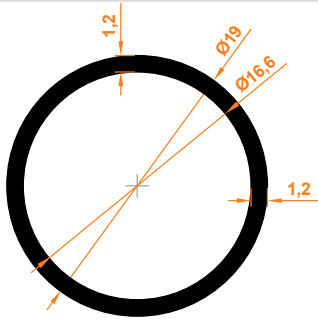

19x1,2 Boru
19x1,2 Pipe

Paket İçi Adet
Quantity Per Package

12

704

0,162 kg/m

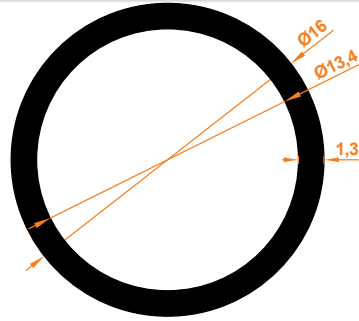

16x1,3 Boru
16x1,3 Pipe

Paket İçi Adet
Quantity Per Package

12

AHŞAP JALUZİ PROFİL GRUBU
Wooden Venetian Blind Profile Group

30

0,600 kg/m

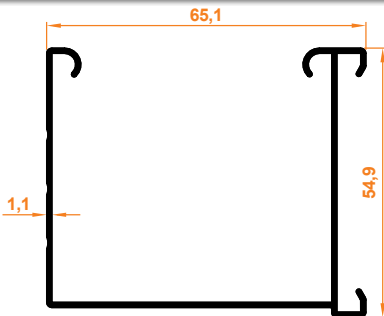

Ahşap Jaluzi Perde Kasa Profil
Venetian Blind Headrail Profile

Paket İçi Adet
Quantity Per Package

6

1003

0,253 kg/m

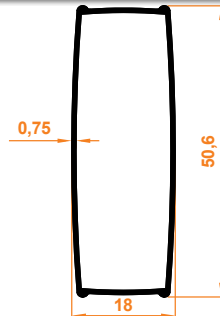

Ahşap Jaluzi Perde Etek Profil
Venetian Blind Bottomrail Profile

Paket İçi Adet
Quantity Per Package

6

250

1,288 kg/m

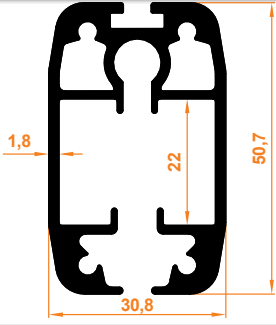

Kanat Profili
Wing Profile

Paket İçi Adet
Quantity Per Package

2

251

0,572 kg/m

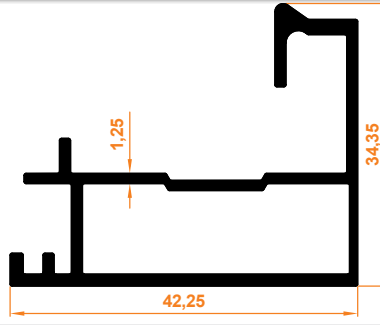

Yan Kasa Profili
Side Case Profile

Paket İçi Adet
Quantity Per Package

6

252

0,313 kg/m

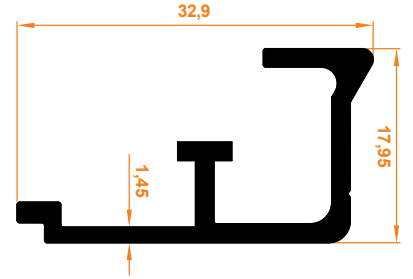

Yan Kasa Kapak Profili
Side Case Cover Profile

Paket İçi Adet
Quantity Per Package

10

7150

1,776 kg/m

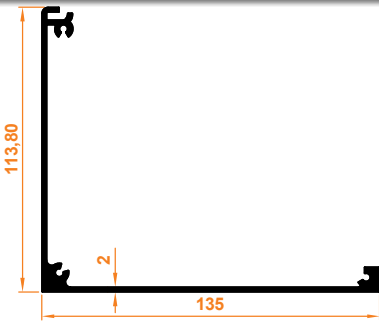

Üst Kasa Profili
Upper Case Profile

Paket İçi Adet
Quantity Per Package

2

7151

1,475 kg/m

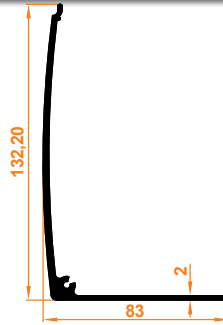

Üst Kasa Kapak Profili
Upper Case Cover Profile

Paket İçi Adet
Quantity Per Package

2

ZP 13

2,110 kg/m

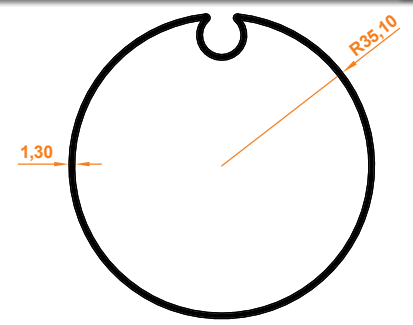

Sac Tambur Borusu
Sheet Drum Tube

Paket İçi Adet
Quantity Per Package

1

ZP 15

0,800 kg/m



5x20 Lama Demir
5x20 Blade Iron

Paket İçi Adet
Quantity Per Package

1

362

0,167 kg/m

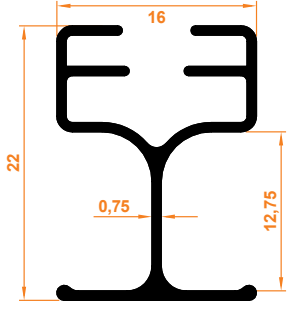

T Profil
T Profile

Paket İçi Adet | 10
Quantity Per Package

334

0,265 kg/m

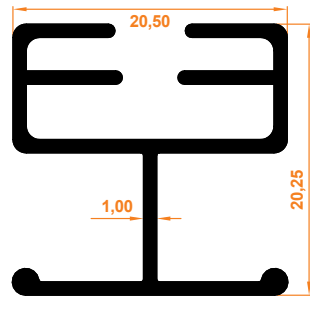

20'lik T Profil
20 T Profile

Paket İçi Adet | 10
Quantity Per Package

339

0,102 kg/m

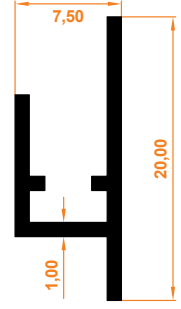

Yaylı Yapışkan Profil
Spring Adhesive Profile

Paket İçi Adet | 10
Quantity Per Package

332

0,094 kg/m

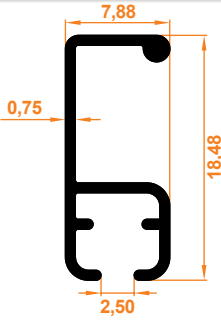

Small T Profil
Small T Profile

Paket İçi Adet | 10
Quantity Per Package

340

0,076 kg/m

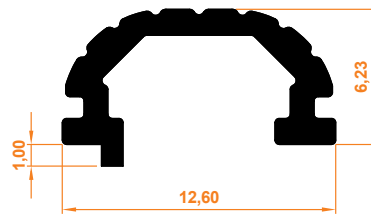

Yaylı Portray Profil
Spring Portray Profile

Paket İçi Adet | 10
Quantity Per Package

327

0,252 kg/m

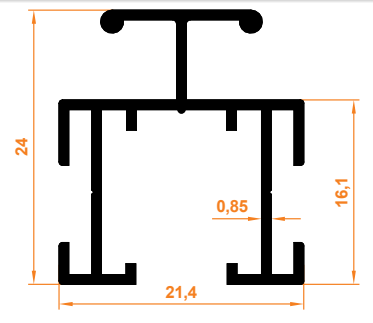

Çiftli Orta Profil
Double Middle Profile

Paket İçi Adet | 10
Quantity Per Package

330

0,105 kg/m



Portray Yapışkan Profil
Adhesive Profile

Paket İçi Adet | 10
Quantity Per Package

357

0,162 kg/m

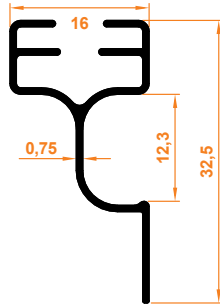

Etekli T Profil
Extended T Profile

Paket İçi Adet | 10
Quantity Per Package

20

0,203 kg/m

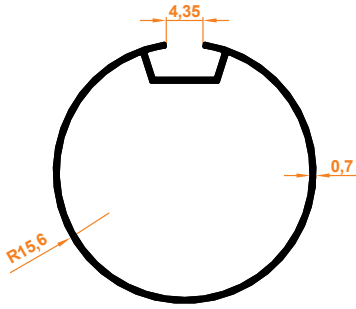

32'lik Boru
Ø32 Roller Tube

Paket İçi Adet | 10
Quantity Per Package

21

0,420 kg/m

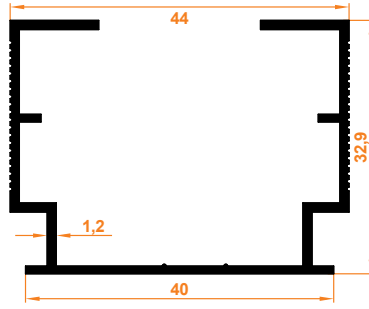

Dikey Geniş Kasa
Vertical Wide Headbox

Paket İçi Adet | 10
Quantity Per Package

23

0,185 kg/m

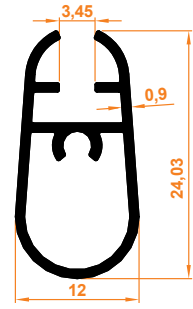

Minyatür Lama
Mini Flat Bar

Paket İçi Adet | 10
Quantity Per Package

24

0,188 kg/m

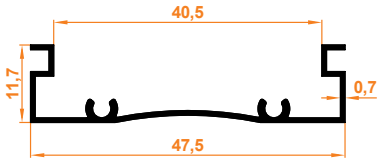

Stor Perde Kasa Tırnaksız
Toothless Headbox for Roller Blinds

Paket İçi Adet | 10
Quantity Per Package

25

0,240 kg/m

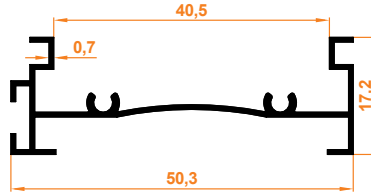

Zebra Açık Kasa
Open Cassette for Zebra Blinds

Paket İçi Adet | 10
Quantity Per Package

26

0,106 kg/m

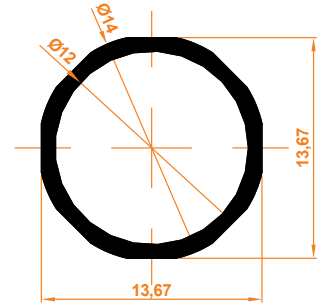

Zebra Mil
Zebra Blind Shaft

Paket İçi Adet | 10
Quantity Per Package

27

0,362 kg/m

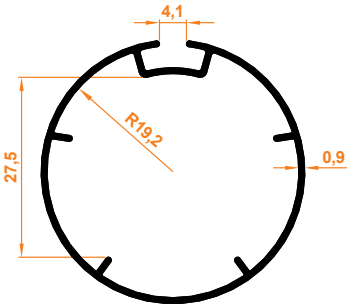

Zebra Perde Borusu
Zebra Blind Tube

Paket İçi Adet | 7
Quantity Per Package

28

0,549 kg/m

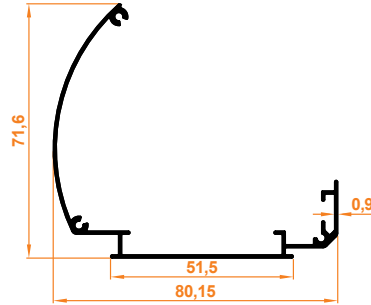

Zebra Perde Kapalı Kasa
Closed Cassette for Zebra Blinds

Paket İçi Adet | 6
Quantity Per Package

29

0,060 kg/m

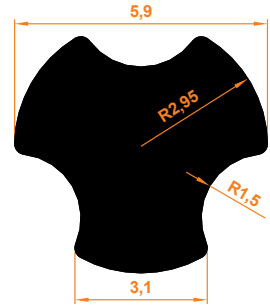

Zebra Dikey Mil
Vertical Shaft for Zebra Blinds

Paket İçi Adet | 25
Quantity Per Package

200

0,136 kg/m

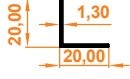

20x20 Köşebent
20x20 Angle Bracket

Paket İçi Adet | 15
Quantity Per Package

201

0,207 kg/m

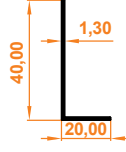

20x40 Köşebent
20x40 Angle Bracket

Paket İçi Adet | 15
Quantity Per Package

202

0,277 kg/m

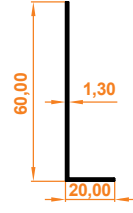

20x60 Köşebent
20x60 Angle Bracket

Paket İçi Adet | 10
Quantity Per Package

204

0,347 kg/m

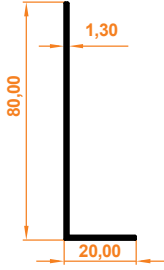

20x80 Köşebent
20x80 Angle Bracket

Paket İçi Adet | 10
Quantity Per Package

203

0,418 kg/m

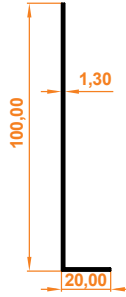

20x100 Köşebent
20x100 Angle Bracket

Paket İçi Adet | 5
Quantity Per Package

205

0,488 kg/m

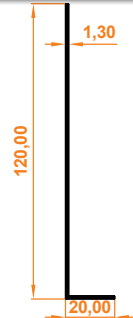

20x120 Köşebent
20x120 Angle Bracket

Paket İçi Adet | 5
Quantity Per Package

206

0,592 kg/m

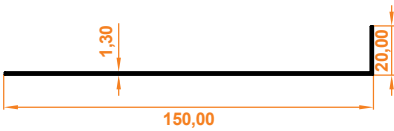

20x150 Köşebent
20x150 Angle Bracket

Paket İçi Adet | 5
Quantity Per Package

404

0,384 kg/m

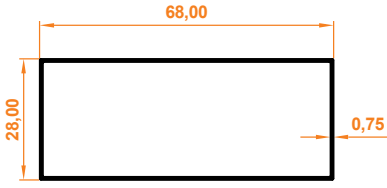

28x68 Kutu Profil
28x68 Box Profile

Paket İçi Adet
Quantity Per Package

4

1044

0,960 kg/m

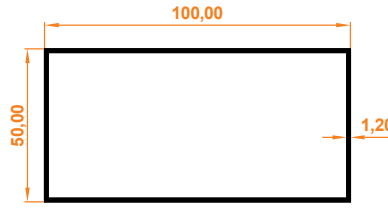

50x100 Kutu Profil
50x100 Box Profile

Paket İçi Adet
Quantity Per Package

5

1102

0,531 kg/m

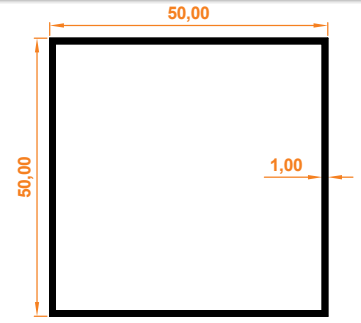

50x50 Kutu Profil
50x50 Box Profile

Paket İçi Adet
Quantity Per Package

3

1400

0,426 kg/m

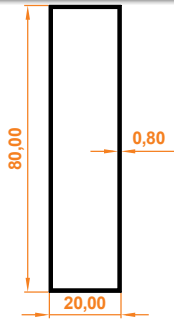

20x80 Kutu Profil
20x80 Box Profile

Paket İçi Adet
Quantity Per Package

5

1402

0,917 kg/m

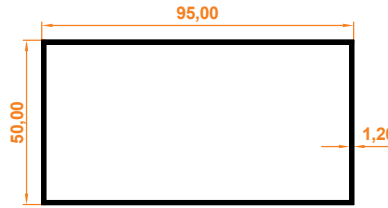

95x50 Kutu Profil
95x50 Box Profile

Paket İçi Adet
Quantity Per Package

3

1403

0,505 kg/m

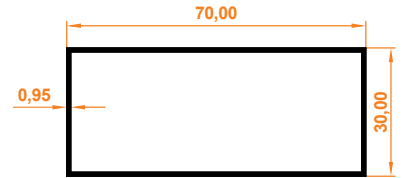

30x70 Kutu Profil
30x70 Box Profile

Paket İçi Adet
Quantity Per Package

5

920

0,422 kg/m

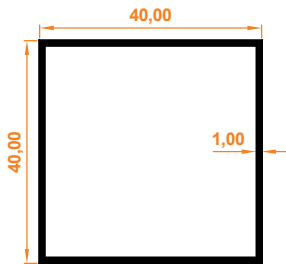

40x40 Kutu Profil
40x40 Box Profile

Paket İçi Adet
Quantity Per Package

6

921

0,477 kg/m

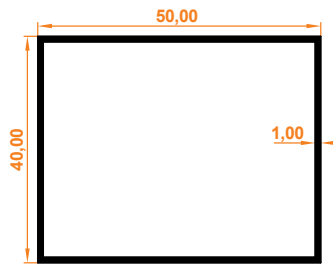

40x50 Kutu Profil
40x50 Box Profile

Paket İçi Adet
Quantity Per Package

8

922

0,531 kg/m

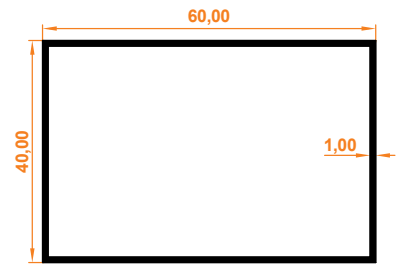

40x60 Kutu Profil
40x60 Box Profile

Paket İçi Adet
Quantity Per Package

8

7180

0,576 kg/m

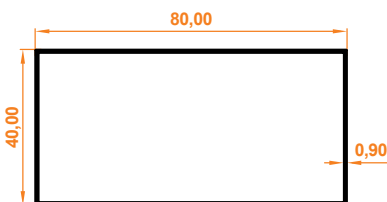

40x80 Kutu Profil
40x80 Box Profile

Paket İçi Adet
Quantity Per Package

4

7

0,305 kg/m

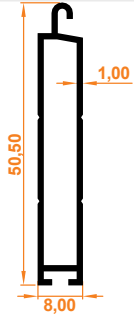

39x55 Alt Parça
39x55 Lower Part

Paket İçi Adet
Quantity Per Package

6

8

0,502 kg/m

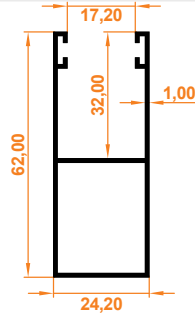

55'lik Yan Dikme
55 Side Column

Paket İçi Adet
Quantity Per Package

5

9

0,439 kg/m

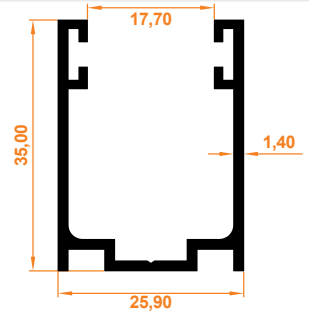

55'lik Kutusuz Dikme
55 Side Column Boxless

Paket İçi Adet
Quantity Per Package

6

1130

0,372 kg/m

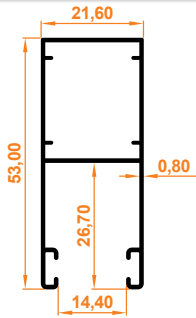

39'luk Yan Dikme
39 Side Column

Paket İçi Adet
Quantity Per Package

5

ÖZEL ÜRETİM PROFİL GRUBU
Special Production Profile Group

510

1,174 kg/m

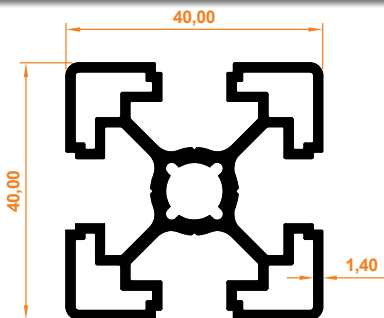

40x40 Sigma Profil
40x40 Sigma Profile

Paket İçi Adet
Quantity Per Package

3

1003

0,053 kg/m

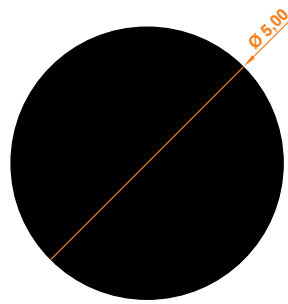

Q5 Dolu Mil
Q5 Solid Bar

Paket İçi Adet
Quantity Per Package

25

İNNOVATİF ÜRETİM
GENİŞ BAYİ AĞI

Sektörde Öncü Marka



INNOVATIVE PRODUCTION
WIDE DISTRIBUTOR NETWORK

Leading Brand in the Industry





 demarco  panjurmen  prosin  process plise

 Process Alüminyum Plastik San. Tic. Ltd. Şti.

MERKEZ

Aşağıpınarbaşı OSB Mah. 524 Nolu Sk. No: 3/1
42250, Selçuklu-Konya/TÜRKİYE

T : +90 332 248 00 92

F : +90 332 248 00 93

M : info@process.com.tr

MARMARA BÖLGE MÜDÜRLÜĞÜ

Cihangir Mh. Talatpaşa Cad. No:67
Avcılar/İSTANBUL - TÜRKİYE

T : +90 212 407 17 42

F : +90 212 407 15 42

M : marmara@process.com.tr

www.demarco.com.tr

www.processplise.com.tr

www.panjurmen.com.tr

www.prosin.com.tr

www.process.com.tr

