





Firmamız, **Process Alüminyum ve PVC Sistemleri** ünvanıyla 2002 yılında Konya'da kurulmuştur.

Firmamızın uzmanlaştığı üretim alanları; sineklik sistemleri, cam balkon sistemleri, plise perde sistemleri, zip perde, cam tavan ve tavan kapatma sistemleridir. Tüm bu sistemleri oluşturan plastik aksesuarlar, alüminyum profiller ve polyester tül ile plise perde kumaşları, kendi tesislerimizde üretilmektedir. Tesisimiz 35.000 m<sup>2</sup> kapalı, 15.000 m<sup>2</sup> açık alanı olmak üzere toplam 50.000 m<sup>2</sup>'dir. Plastik enjeksiyon üretim bölümünde 15 adet enjeksiyon makinesi ile 24 saat çalışma esasıyla günlük ortalama 300.000 adet parça üretebilmektedir. Alüminyum ekstrüzyon bölümümüzde aylık ortalama 850 ton alüminyum profil üretilmektedir. Üretilen alüminyum profiller yine kendi tesisimizde yüzey işlemlerinden (eloksal - elektrostatik boya) geçmekte ve son olarak paketlenip sevk edilmektedir. Türkiye içerisinde 900 civarında atölyede ürünlerimiz işlenmekte ve son tüketiciye ulaştırılmaktadır. Türkiye dışında Balkan ülkelerinin tamamı, Avrupa Kıtasında; Almanya, Hollanda, Danimarka, Kuzey Afrikada; Tunus ve Cezayir, Orta Doğuda; Irak ve İsrail'in yanısıra Ermenistan, Azerbaycan, Arap Emirlikleri, Dubai, Katar, Ürdün gibi ülkelerde bayilikler oluşturulmuştur. Şu anda toplam ürünlerimizin %35'ini ihraç etmekteyiz.

Perde sektöründe son zamanların trend ürünü olan plise perde sistemlerini kendi Ar-Ge merkezimizde geliştirerek sektörün hizmetine sunmuş bulunmaktadır. Mekanik perde atölyeleri tarafından bugüne kadar Türkiye genelinde 150 adet bayilik oluşturulmuş ve bu bayilikler artarak çoğalmaktadır. Plise perdeyi oluşturan tüm parçaları; plastik aksesuarlar, alüminyum çita ve profiller, katlanmış pileli kumaşlar ürünlerimizi kendi tesislerimizde üretilip bayilerimize ulaştırmaktayız. 167 farklı desen ve renkte kumaş çeşidi olan firmamız çok güçlü stok altyapısı ile sektörün ihtiyacı olan hizmeti ve hızı sunmaktadır.

Our company, operating under the name of **Process Aluminum and PVC Systems**, was founded in 2002 in Konya.

**Process** specializes in the production of the following areas: insect screen systems, glass balcony systems, pleated blind systems, zip blinds, glass roofs, and ceiling closure systems. All the plastic accessories, aluminum profiles, polyester mesh, and pleated blind fabrics that make up these systems are manufactured in our own facilities. Our facility covers a total area of 50,000 m<sup>2</sup>, with 35,000 m<sup>2</sup> being indoors and 15,000 m<sup>2</sup> outdoors. In the plastic injection production department, we can produce an average of 300,000 pieces per day with 15 injection machines operating 24 hours a day. In our aluminum extrusion department, an average of 850 tons of aluminum profiles are produced monthly. The aluminum profiles produced undergo surface treatments (anodizing - electrostatic paint) in our own facilities before being packaged and shipped. Within Turkey, our products are processed in approximately 900 workshops and delivered to end consumers. Outside of Turkey, we have established dealerships in all Balkan countries, across the European continent including Germany, the Netherlands, and Denmark, in North Africa including Tunisia and Algeria, in the Middle East including Iraq and Israel, as well as in countries such as Armenia, Azerbaijan, the United Arab Emirates, Dubai, Qatar, Jordan, and more. Currently, we export 35% of our total products.

In the curtain sector, our company has developed and introduced pleated blind systems, the trend product of recent years, to the sector through our own R&D center. Nowadays, we have established 150 dealerships across Turkey in the mechanical curtain workshops, and these dealerships continue to increase. We manufacture all the components that make up pleated blinds, including plastic accessories, aluminum bars, profiles, and folded pleated fabrics, in our own facilities and deliver them to our dealers. With 167 different patterns and colors of fabric, our company provides the service and speed that the sector needs with its strong stock infrastructure.





GELECEK YAPI MİMARİ  
**Tüm Yaşam Alanlarında**

In all living areas

Future Structure Architecture



**KALİTE**  
QUALITY

**EKONOMİK**  
ECONOMIC

**GARANTİ**  
WARRANTY



ÜRÜN KODU Product Code	ÖZELLİKLERİ Properties	ÖLÇÜLERİ Dimensions	KOLI İÇİ ADET Amount within Parcel
PJM - 01	Panjurmen Menfez / Vent	27 x 32	20
PJM - 02	Panjurmen Menfez / Vent	25 x 45	20
PJM - 19	Panjurmen Menfez / Vent	30 x 30	20
PJM - 16	Panjurmen Menfez / Vent	30 x 40	20
PJM - 03	Panjurmen Menfez / Vent	35 x 35	20
PJM - 04	Panjurmen Menfez / Vent	35 x 45	20
PJM - 05	Panjurmen Menfez / Vent	35 x 55	20
PJM - 06	Panjurmen Menfez / Vent	40 x 40	20
PJM - 15	Panjurmen Menfez / Vent	40 x 50	20
PJM - 07	Panjurmen Menfez / Vent	45 x 45	20
PJM - 08	Panjurmen Menfez / Vent	45 x 55	20
PJM - 09	Panjurmen Menfez / Vent	45 x 65	20
PJM - 10	Panjurmen Menfez / Vent	65 x 45	20
PJM - 11	Panjurmen Menfez / Vent	50 x 50	20
PJM - 17	Panjurmen Menfez / Vent	50 x 60	20
PJM - 12	Panjurmen Menfez / Vent	55 x 55	20
PJM - 13	Panjurmen Menfez / Vent	55 x 65	20
PJM - 18	Panjurmen Menfez / Vent	60 x 60	20
PJM - 14	Panjurmen Menfez / Vent	65 x 65	15

### Alüminyum Renk Seçeneği

Aluminum Color Options

PB

Parlak Eloksal  
Gloss Anodized

P0

Parlak Bronz  
Gloss Bronze

7016

Antrasit Gri  
Anthracite Gray



ÜRÜN ADI Product Name	ÜRÜN KODU Product Code	KOLİ İÇİ ADET Amount within Parcel
Boru Tipi Çamaşır Askısı Pipe Type Clotheshorse	CMS 01	20



ÜRÜN ADI Product Name	ÜRÜN KODU Product Code	KOLİ İÇİ ADET Amount within Parcel
Lüks Çamaşır Askısı Luxurious Clotheshorse	CMS 04	20



ÜRÜN ADI Product Name	ÜRÜN KODU Product Code	KOLİ İÇİ ADET Amount within Parcel
Ayarlı Kare Çamaşırılık (25x60cm ve 30x80 cm) Adjustable Square Clotheshorse (25x60cm and 30x80cm)	CMS 05	20



ÜRÜN ADI Product Name	ÜRÜN KODU Product Code	KOLİ İÇİ ADET Amount within Parcel
Duvar Tipi Çamaşır Askısı Wall Type Clotheshorse	CMS 02	15



ÜRÜN ADI Product Name	AÇIKLAMA Explanation
<b>Doğalgaz Takım (Isıcam)</b> Natural Gas Set (Double-Glass)	3 m
<b>Doğalgaz Sağ-Sol Başlık</b> Natural Gas Right-Left Header (CAP)	<b>Adet</b> Pcs
<b>Doğalgaz Takım (Tekcam 8mm)</b> Natural Gas Set (Single-Glass 8mm)	3 m
<b>Doğalgaz Takım (Tekcam 10mm)</b> Natural Gas Set (Single-Glass 10mm)	<b>Adet</b> Pcs
<b>Doğalgaz Sağ-Sol Başlık</b> Natural Gas Right-Left Header (CAP)	3 m
<b>Oda Havalandırma</b> Room Ventilation	3 m
<b>Sağ-Sol Başlık</b> Right Left Header (CAP)	<b>Adet</b> Pcs

**ONAYLI ÜRÜN**  
APPROVED PRODUCT



Ürünlerimiz Patentli Olup;  
IGDAŞ Onaylıdır.

Our products have patent  
and approved by IGDAŞ.

## AYARLI CAM TAKOZU

Adjustable Glass Wedges

ÜRÜN ADI Product Name	ÜRÜN KODU Product Code	KOLİ İÇİ ADET (m <sup>2</sup> ) Amount within Parcel (m <sup>2</sup> )
<b>18 mm Ayarlı Cam Takozu</b> / 18 mm Adjustable Glass Wedge	ACT 1	500
<b>24 mm Ayarlı Cam Takozu</b> / 24 mm Adjustable Glass Wedge	ACT 2	400
<b>28 mm Ayarlı Cam Takozu</b> / 28 mm Adjustable Glass Wedge	ACT 3	400
<b>32 mm Ayarlı Cam Takozu</b> / 32 mm Adjustable Glass Wedge	ACT 4	400
<b>Ayarlı Cam Takozu Pensesi</b> / Adjustable Glass Wedge Holder	ACT 5	1



### ÖZELLİKLER

PROPERTIES

Kanat sarkmalarını ortadan kaldırır.  
It removes wing sagging.

PVC, ahşap ve alüminyum doğramalarda kullanılabilir.  
It can be used in PVC, wood and aluminum joiner.

Ayar pensesi sayesinde kanadınızın kolaylıkla teraziye alınmasını sağlar.  
It provides balancing your wind easily by means of adjustment claw.

Ekstra takoz seçeneğiyle standartların üzerinde kaldırma kapasitesine sahiptir.  
It has lifting capacity over standard by means of extra wedge option.





ÜRÜN KODU Product Code	ÖLÇÜLERİ Dimensions	KOLI İÇİ RULO Amount within Parcel (roll)	RULO/METRE Roll/Meter	KOLI İÇİ ADET (m) Amount within Parcel (m)
FİTİL 72	45-800	4	275	1.100
FİTİL 01	48-300	4	800	3.200
FİTİL 02	48-450	4	550	2.200
FİTİL 03	48-500	4	550	2.200
FİTİL 04	48-550	4	500	2.000
FİTİL 05	48-600	4	450	1.800
FİTİL 06	48-650	4	450	1.800
FİTİL 07	48-700	4	400	1.600
FİTİL 08	48-800	4	275	1.100
FİTİL 66	48-900	4	250	1.000
FİTİL 09	48-1000	4	250	1.000
FİTİL 10	48-1200	4	200	800
FİTİL 60	48-1500	4	150	600
FİTİL 11	51-500	4	375	1.500
FİTİL 54	51-550	4	375	1.500
FİTİL 12	51-650	4	350	1.400
FİTİL 13	51-800	4	325	1.300
FİTİL 14	51-1000	4	250	1.000
FİTİL 15	51-1200	4	200	800
FİTİL 16	55-550	4	375	1.500
FİTİL 68	55-600	4	350	1.400
FİTİL 67	55-650	4	350	1.400
FİTİL 17	55-700	4	350	1.400
FİTİL 18	55-800	4	325	1.300
FİTİL 65	55-1000	4	250	1.000
FİTİL 19	60-575	4	350	1.400
FİTİL 20	67-450	4	375	1.500
FİTİL 21	67-500	4	375	1.500
FİTİL 22	67-550	4	375	1.500
FİTİL 23	67-600	4	350	1.400
FİTİL 24	67-650	4	350	1.400
FİTİL 46	67-700	4	300	1.200
FİTİL 26	67-800	4	250	1.000
FİTİL 61	67-900	4	225	900
FİTİL 28	67-1000	4	200	800
FİTİL 29	67-1100	4	175	700
FİTİL 30	67-1200	4	175	700
FİTİL 31	67-1500	4	125	500
FİTİL 32	67-1800	4	125	500
FİTİL 33	67-2000	4	100	400
FİTİL 74	67-2500	4	75	300
FİTİL 34	69-550	4	375	1.500
FİTİL 35	69-700	4	250	1.000
FİTİL 36	69-1000	4	200	800
FİTİL 37	69-1200	4	175	700
FİTİL 38	72-800	4	200	800
FİTİL 39	127-700	4	175	700
FİTİL 73	51-550 Finli	4	350	1.400
FİTİL 40	51-650 Finli	4	325	1.300
FİTİL 41	51-800 Finli	4	300	1.200
FİTİL 42	51-1000 Finli	4	225	900
FİTİL 77	55-650 Finli	4	325	1.300
FİTİL 43	55-700 Finli	4	325	1.300
FİTİL 44	55-800 Finli	4	300	1.200
FİTİL 45	60-575 Finli	4	325	1.300
FİTİL 76	67-600 Finli	4	325	1.300
FİTİL 55	67-650 Finli	4	325	1.300
FİTİL 58	67-700 Finli	4	275	1.100
FİTİL 47	67-1000 Finli	4	175	700
FİTİL48	67-1200 Finli	4	150	600
FİTİL 49	69-700 Finli	4	225	900
FİTİL 50	69-800 Finli	4	225	900
FİTİL 51	69-1000 Finli	4	175	700
FİTİL 52	72-800 Finli	4	175	700
FİTİL 53	127-700 Finli	4	150	600

ÜRÜN ADI Product Name	ÜRÜN KODU Product Code	RULO m <sup>2</sup> Roll m <sup>2</sup>	KOLİ İÇİ ADET (m <sup>2</sup> ) Amount within Parcel (m <sup>2</sup> )
60cmx30m Sineklik Tülü / 60cmx30m Flynet Tulle	60 S	18 m <sup>2</sup>	6
80cmx30m Sineklik Tülü / 80cmx30m Flynet Tulle	80 S	24 m <sup>2</sup>	6
100cmx30m Sineklik Tülü / 100cmx30m Flynet Tulle	100 S	30 m <sup>2</sup>	6
120cmx30m Sineklik Tülü / 120cmx30m Flynet Tulle	120 S	36 m <sup>2</sup>	6
140cmx30m Sineklik Tülü / 140cmx30m Flynet Tulle	140 S	42 m <sup>2</sup>	6
160cmx30m Sineklik Tülü / 160cmx30m Flynet Tulle	160 S	48 m <sup>2</sup>	6
180cmx30m Sineklik Tülü / 180cmx30m Flynet Tulle	180 S	54 m <sup>2</sup>	6
200cmx30m Sineklik Tülü / 200cmx30m Flynet Tulle	200 S	60 m <sup>2</sup>	6
220cmx30m Sineklik Tülü / 220cmx30m Flynet Tulle	220 S	66 m <sup>2</sup>	6
240cmx30m Sineklik Tülü / 240cmx30m Flynet Tulle	240 S	72 m <sup>2</sup>	6
Pet Tül 160 / Pet Tulle 160	160 PET	16 m <sup>2</sup>	6
Pet Tül 220 / Pet Tulle 220	220 PET	22 m <sup>2</sup>	6

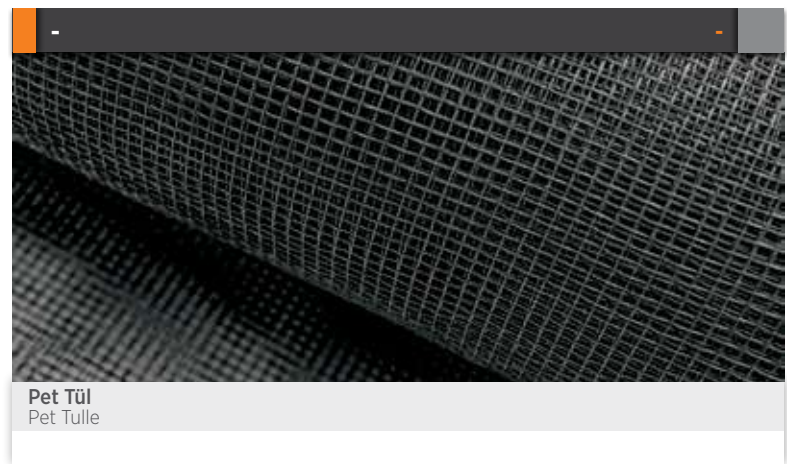



## GOLD SERİ PLİSE SİNEKLİK / GOLD SERIES PLEATED FLY SCREEN

### İçten Gergi

Internal Tensioner

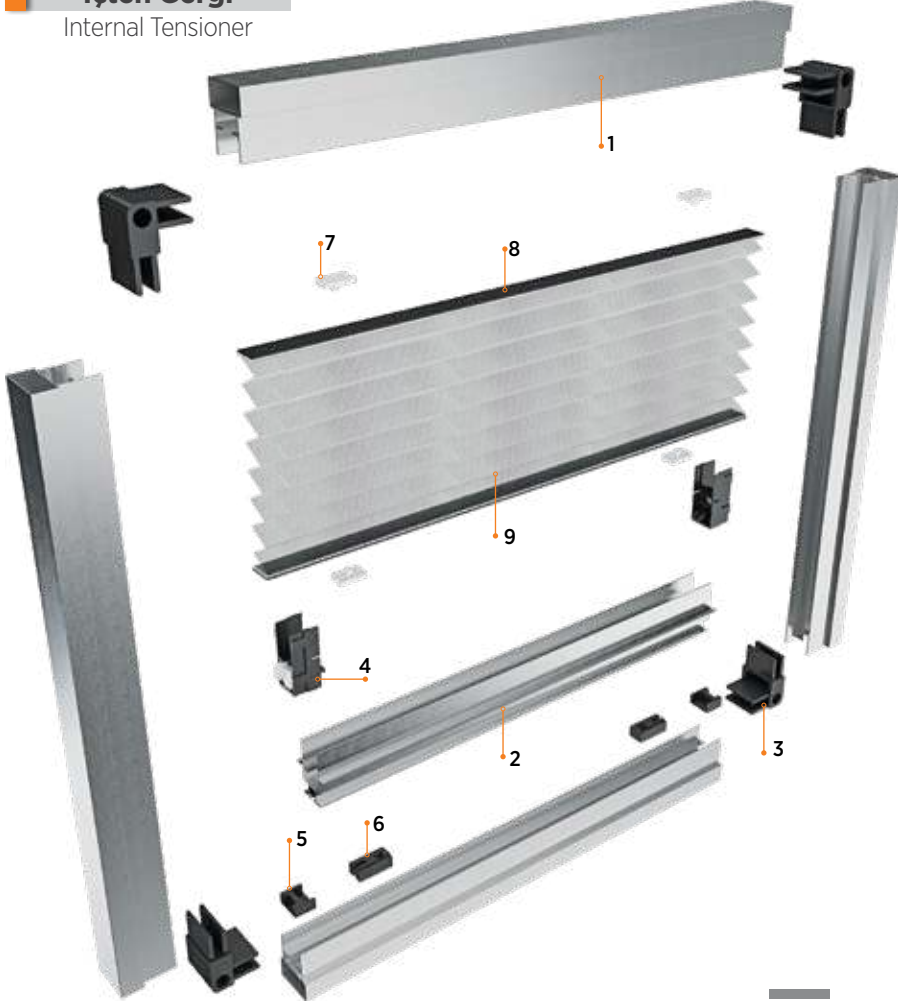

### İçten Gergi Set İçeriği / Internal Tensioner Set Contents

No	ÜRÜN KODU Product Code	ÜRÜN ADI Product Name
1	304	Gold Kasa Gold Case
2	305	Gold Kanat Gold Wing
3	-	Köşe Takoğu Corner Wedge
4	-	Rulman Takımı Bearing Set
5	-	İp Kontrol Plastiği Rope Control Plastic
6	-	İp Gergi Takoğu Rope Tensioner Chock
7	-	Delikli Klips Hole Clip
8	-	Plise Serit Pleat Ribbon
9	-	Plise Tül Pleat Tulle

Özellikle kapılar için çok tercih edilen bir seridir, tül ağı bir tarafta veya her iki tarafta kasa içerisine katlanır.

Pileli kaset, alüminyum kasa profili ile kapı veya pencere pervazına, köşe takozlarında yer alan montaj deliklerinden vida yardımıyla doğrudan ve kolayca sabitlenir.

This model is a terrifically preferential profile particularly for doors, tulle is folded into the one side of the case frame or even two sides of the case frame.

The pleated tape is fastened straightly and easily to the door or window sill with the support of screws through the mounting holes in the corner wedges with the aluminum frame case profile.



**304**  
Gold Kasa Profil  
Gold Case Profile  
Paket İçi Adet  
Amount within package 10 Gramajı  
Weight 0,318 kg/m



**305**  
Gold Kanat Profil  
Gold Wing profile  
Paket İçi Adet  
Amount within package 10 Gramajı  
Weight 0,330 kg/m



**AKS 09**  
**AKS 10** Beyaz / White  
Siyah / Black  
Gold Seri İçten Gergi Aksesuar Seti  
Gold Serie Internal Tensioner Accessory Set  
Koli İçi Adet  
Amount within parcel 100 Set

### Alüminyum Renk Seçeneği

Aluminum Color Options

**9016**

Beyaz  
White

**9016**

Eloksal Boyalı  
Anodized Painted

**9016**

Bronz Boyalı  
Bronze Painted

**8003**

Altın Meşe  
Golden Oak

**8016**

Maun  
Mahogany

**7016**

Antrasit Gri  
Anthracite Gray

**STAR SERİ PLİSE SİNEKLİK / STAR SERIES PLEATED FLY SCREEN**

**Köşeden Gergi**

Corner Tensioner



Kanat hareketliliğini sağlayan ipler kasa içerisinde ip gergi aparatı ile sabitlenen modelinin yanı sıra köşe takozunda yer alan ip gergi vida ile iğin sabitlendiği modeli de mevcuttur.

Kasa genişliği Gold seriye göre daha dar olduğu için kimi alanlarda montaj kolaylığı sağlamaktadır.

The rope which lets the wing frame move is stabled with the rope tensioner in the case frame. Also, this rope is fixed with the rope tension screw in the corner of the profile.

Due to the case frame width of the Star Series is narrower than the Gold series, in some areas it provides simple installation.

**İçten Gergi**

Internal Tensioner



**İçten Gergi Set İçeriği / Internal Tensioner Set Contents**

No	ÜRÜN KODU Product Code	ÜRÜN ADI Product Name
1	302	Star Kasa Star Case
2	301	Star Kanat Star Wing
3	-	Köşe Takozu Corner Wedge
4	-	Rulman Takımı Bearing Set
5	-	İp Kontrol Rope Control
6	-	İp Gergi Takozu Rope Tensioner Chock
7	-	Delikli Klips Hole Clip
8	-	Plise Tül Pleat Tulle
9	-	Plise Şerit Pleat Ribbon

**Köşeden Gergi Set İçeriği / Corner Tensioner Set Contents**

No	ÜRÜN KODU Product Code	ÜRÜN ADI Product Name
1	302	Star Kasa Star Case
2	301	Star Kanat Star Wing
3	-	Köşe Takozu Corner Wedge
4	-	Rulman Takımı Bearing Set
5	-	Plise Şerit Pleat Ribbon
6	-	Delikli Klips Hole Clip
7	-	Plise Tül Pleat Tulle

AKS 05  
AKS 06

Beyaz / White  
Siyah / Black



**Star Seri Köşeden Gergi Aksesuar Seti**  
Star Series Corner Tensioner Accessory Set

Koli İçi Adet  
Amount within parcel

100 Set

AKS 07  
AKS 08

Beyaz / White  
Siyah / Black



**Star Seri İçten Gergi Aksesuar Seti**  
Star Serie Internal Tensioner Accessory Set

Koli İçi Adet  
Amount within parcel

100 Set

301



**Star Kanat Profil**  
Star Wing Profile

Paket İçi Adet  
Amount within package

10

Gramajı  
Weight

0,303 kg/m

302



**Star Kasa Profil**  
Star Case Profile

Paket İçi Adet  
Amount within package

10

Gramajı  
Weight

0,272 kg/m

**Alüminyum Renk Seçeneği**

Aluminum Color Options

9016

Beyaz  
White

Eloksal Boyalı  
Anodized Painted

Bronz Boyalı  
Bronze Painted

8003

Altın Meşe  
Golden Oak

8016

Maun  
Mahogany

7016

Antrasit Gri  
Anthracite Gray

## SLİM SERİ PLİSE SİNEKLİK / SLIM SERIES PLEATED FLY SCREEN

### Köşeden Gergi

Corner Tensioner

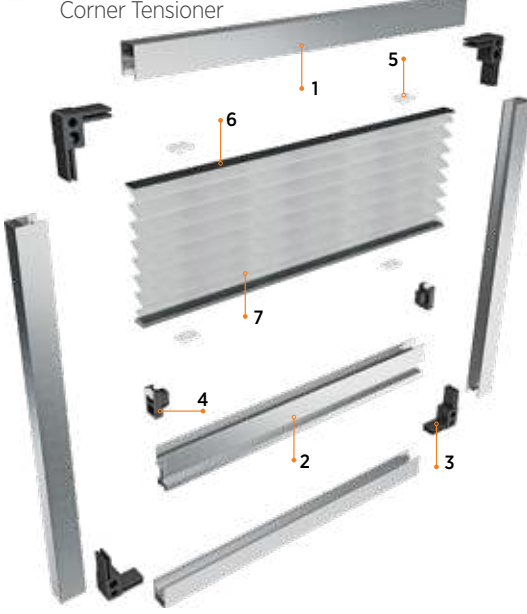

Panjurlu kapı ve pencereler için tasarlanmış bir modeldir. Panjur ile kapı-pencere pervazı arasındaki boşlukta montaj yapılma imkanı sağlamaktadır.

Bu ürün sayesinde panjurlu kapı pencerelerde de sineklik kullanılabilir.

This wonderful system is designed for Louvered doors and windows. It ensures the occasion to be installed in the gap between the shutter and the door-window sill.

Because of its perfect features, the pleated fly screen systems can also be utilized in Louvered door and windows.

### İçten Gergi

Internal Tensioner



### İçten Gergi Set İçeriği / Internal Tensioner Set Contents

No	ÜRÜN KODU Product Code	ÜRÜN ADI Product Name
1	300	Slım Kasa Slim Case
2	301	Slım Kanat Slim Wing
3	-	Köşe Birleştirme Corner Wedge
4	-	Kanat Kapağı Wing Cover
5	-	İp Gergi Takoğu Rope Tensioner Chock
6	-	İp Kontrol Plastiği Rope Control Plastic
7	-	Delikli Klips Hole Clip
8	-	Plise Şerit Pleat Ribbon
9	-	Plise Tül Pleat Tulle

### Köşeden Gergi Set İçeriği / Corner Tensioner Set Contents

No	ÜRÜN KODU Product Code	ÜRÜN ADI Product Name
1	300	Slım Kasa Slim Case
2	301	Slım Kanat Slim Wing
3	-	Köşe Birleştirme Corner Wedge
4	-	Rulman Takımı Bearing Set
5	-	Delik Klips Hole Clip
6	-	Plise Şerit Pleat Ribbon
7	-	Plise Tül Pleat Tulle

### Alüminyum Renk Seçeneği

Aluminum Color Options



9016  
Beyaz  
White



8003  
Altın Meşe  
Golden Oak



8016  
Maun  
Mahogany



7016  
Antrasit Gri  
Anthracite Gray

AKS 01  
AKS 02

Beyaz / White  
Siyah / Black

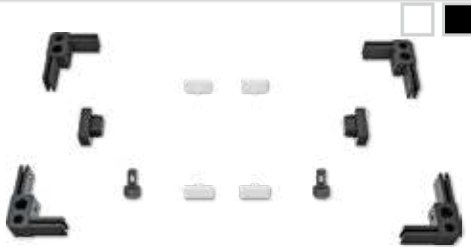

Slım Seri Köşeden Gergi Aksesuar Seti  
Slim Series Corner Tensioner Accessory Set

Koli İçi Adet  
Amount within parcel

100 Set

AKS 01 E  
AKS 02 E

Beyaz / White  
Siyah / Black



Slım Köşeden Gergi Eşiksiz Aksesuar Seti  
Slim Corner Tensioner Accessory Set without Threshold

Koli İçi Adet  
Amount within parcel

100 Set

AKS 03  
AKS 04

Beyaz / White  
Siyah / Black

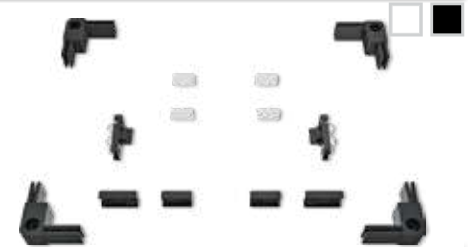

Slım Seri İçten Gergi Aksesuar Seti  
Slim Serie Internal Tensioner Accessory Set

Koli İçi Adet  
Amount within parcel

100 Set

300



Slım Kasa Profil  
Slim Case Profile

Paket İçi Adet  
Amount within package

10

Gramajı  
Weight

0,218 kg/m

331



Slım Eşiksiz Profil  
Slim Profile without Threshold

Paket İçi Adet  
Amount within package

10

Gramajı  
Weight

0,168 kg/m

301



Slım Kanat Profil  
Slim Wing Profile

Paket İçi Adet  
Amount within package

10

Gramajı  
Weight

0,303 kg/m

## JUNIOR SERİ PLİSE SİNEKLİK / JUNIOR SERIES PLEATED FLY SCREEN

### Köşeden Gergi

Corner Tensioner

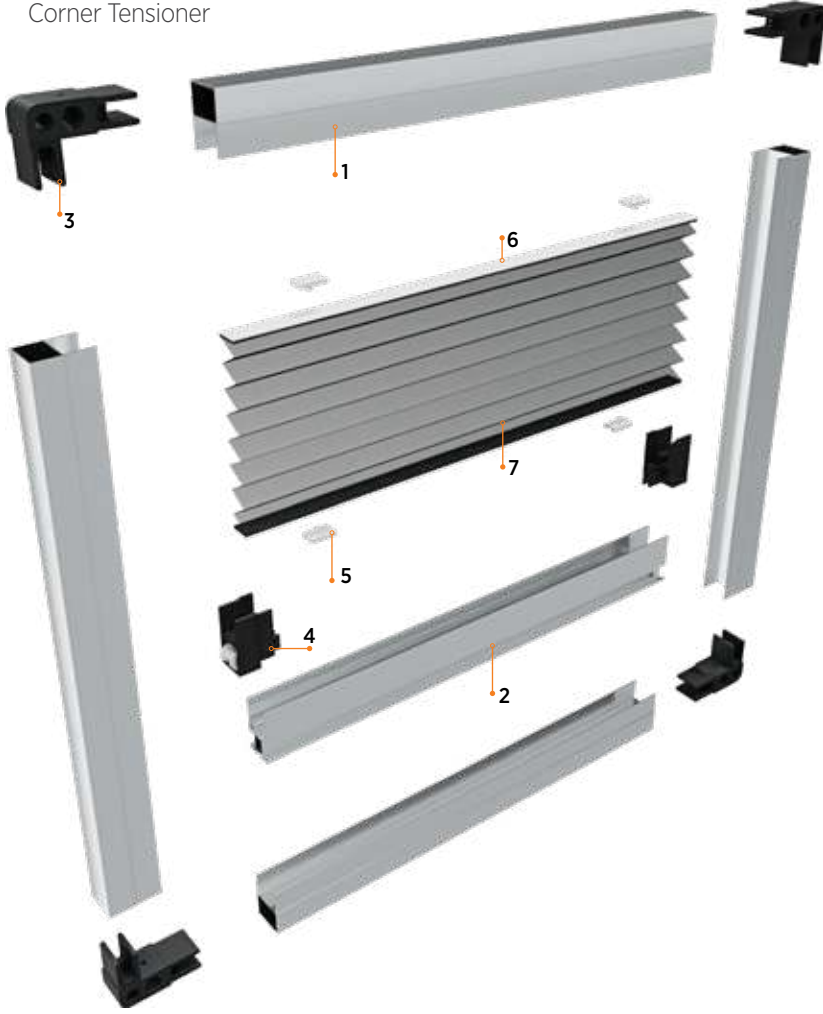

### Köşeden Gergi Set İçeriği / Corner Tensioner Set Contents

No	ÜRÜN KODU Product Code	ÜRÜN ADI Product Name
1	306	Junior Kasa Profili Junior Case Profile
2	307	Junior Kanat Profili Junior Wing Profile
3	-	Köşe Birleştirme Corner Wedge
4	-	Rulman Takımı Bearing Set
5	PLS 11	Delikli Klips Hole Clip
6	PLS 05	Plise Şerit Pleat Ribbon
7	PLS 04	Plise Tül Pleat Tulle

Junior Seri, pratik ve estetik bir sineklik çözümü sunar. Köşeden gergi sistemiyle tasarlanan bu model, kullanımı kolay ve dayanıklıdır. Evinize zarif bir görünüm katan Junior Seri, sineklik ihtiyaçlarınızı en iyi şekilde karşılar.

Junior Series offers a practical and aesthetic solution for insect screens. Designed with a corner tensioning system, this model is easy to use and durable. Adding an elegant look to your home, Junior Series meets your insect screen needs perfectly.



306

Junior Kasa Profil  
Junior Case Profile

Paket İçi Adet Amount within package	10	Gramajı Weight	0,243 kg/m
---	----	-------------------	------------

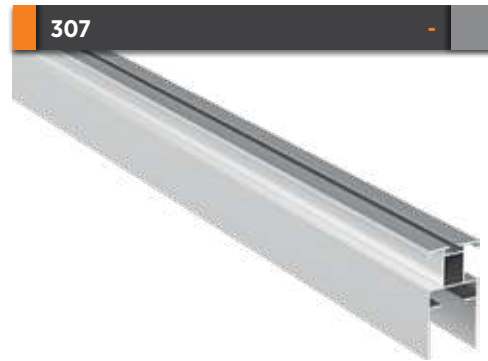

307

Junior Kanat Profili  
Nobel Wing Profile

Paket İçi Adet Amount within package	10	Gramajı Weight	0,304 kg/m
---	----	-------------------	------------



AKS 15  
AKS 16

Beyaz / White  
Siyah / Black

Junior Seri Köşeden Gergi Aksesuar Seti  
Junior Series Corner Tensioner Accessory Set

Koli İçi Adet Amount within parcel	100 Set
---------------------------------------	---------

### Alüminyum Renk Seçeneği

Aluminum Color Options

9016

Beyaz  
White



Eloksal Boyalı  
Anodized Painted



Bronz Boyalı  
Bronze Painted

8003

Altın Meşe  
Golden Oak

8016

Maun  
Mahogany

7016

Antrasit Gri  
Anthracite Gray

## SÜPER SERİ PLİSE SİNEKLİK / SUPER SERIES PLEATED FLY SCREEN

### Köşeden Gergi Corner Tensioner

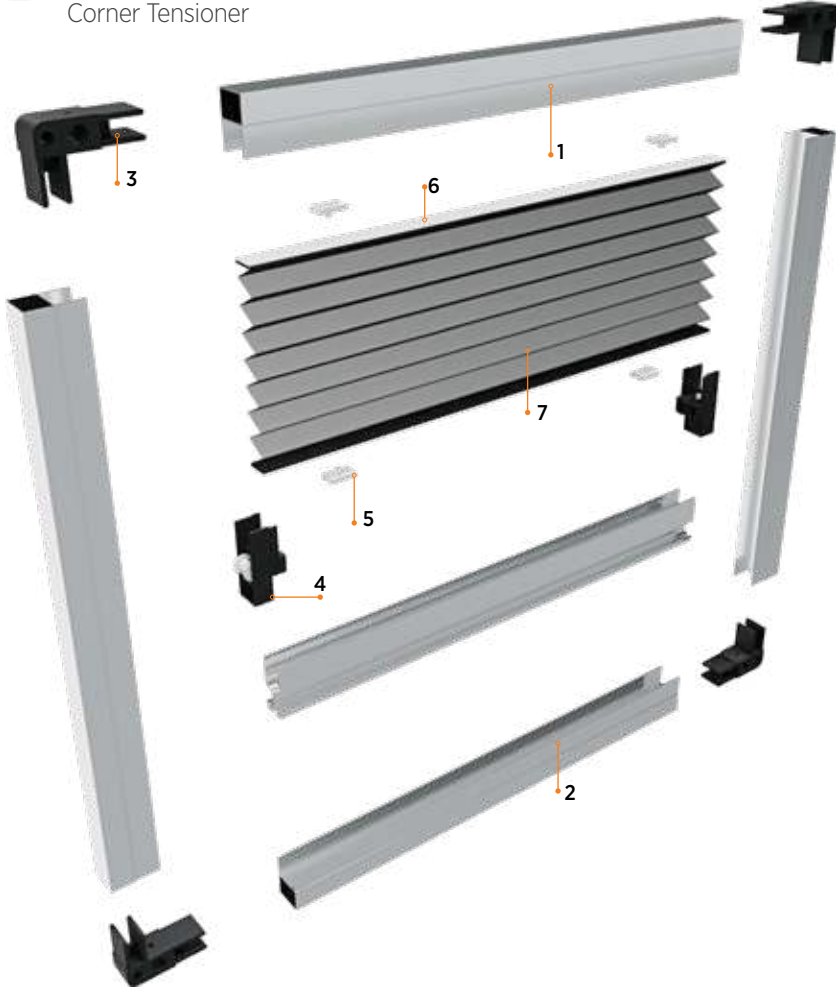

Kapı ve pencereler için tasarlanmış özel bir modeldir. Montajı, panjur ile kapı-pencere pervazı arasındaki boşluğa kolayca yapılabilir. Bu ürün, panjurlu kapı ve pencerelerde de sineklik kullanımını mümkün kılar.

It is a specially designed model for doors and windows with shutters. It can be easily installed in the space between the shutter and the door-window frame. This product allows the use of insect screens on doors and windows with shutters.

### İçten Gergi Set İçeriği / Internal Tensioner Set Contents

No	ÜRÜN KODU Product Code	ÜRÜN ADI Product Name
1	316	Süper Kasa Profili Super Case Profile
2	320	Süper Kanat Profili Super Wing Profile
3	-	Köşe Birleştirme Corner Wedge
4	-	Rulman Takımı Bearing Set
5	PLS 11	Delikli Klips Hole Clip
6	PLS 05	Plise Şerit Pleat Ribbon
7	PLS 04	Plise Tül Pleat Tulle



**316**  
Süper Kasa Profil  
Super Case Profile  
Paket İçi Adet  
Amount within package 10 Gramajı  
Weight 0,318 kg/m



**320**  
Süper Kanat Profil  
Super Wing profile  
Paket İçi Adet  
Amount within package 10 Gramajı  
Weight 0,330 kg/m



**AKS 11**  
**AKS 12**  
Beyaz / White  
Siyah / Black  
Süper Seri Köşeden Gergi Aksesuar Seti  
Super Serie Corner Tensioner Accessory Set  
Koli İçi Adet  
Amount within parcel 100 Set

### Alüminyum Renk Seçeneği Aluminum Color Options

**9016**  
Beyaz  
White

**Eloksal Boyalı**  
Anodized Painted

**Bronz Boyalı**  
Bronze Painted

**8003**  
Altın Meşe  
Golden Oak

**8016**  
Maun  
Mahogany

**7016**  
Antrasit Gri  
Anthracite Gray

**NOBEL SERİ PLİSE SİNEKLİK / NOBEL SERIES PLEATED FLY SCREEN**

**Köşeden Gergi**

Corner Tensioner

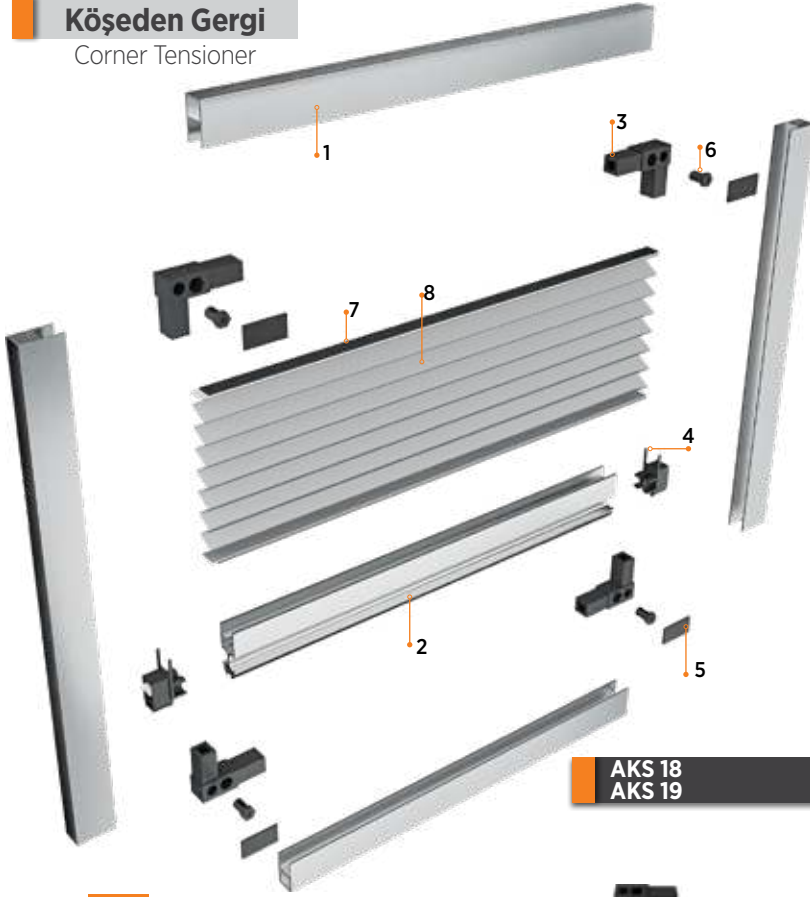

**Yeni Ürün New Product**

**Köşeden Gergi Set İçeriği / Corner Tensioner Set Contents**

No	ÜRÜN KODU Product Code	ÜRÜN ADI Product Name
1	338	<b>Nobel Kasa Profili</b> Nobel Case Profile
2	335	<b>Nobel Kanat Profili</b> Nobel Wing Profile
3	-	<b>Nobel Köşe Takoğu</b> Nobel Corner Wedge
4	-	<b>Nobel Rulman Takımı</b> Nobel Bearing Set
5	-	<b>Nobel Köşe Takoğu Kapağı</b> Nobel Corner Wedge Lid
6	-	<b>Nobel Köşe Takoğu Pimi</b> Nobel Corner Wedge Pin
7	-	<b>Plise Şerit</b> Pleat Ribbon
8	-	<b>Plise Tül</b> Pleat Tulle

**AKS 18**  
**AKS 19**

**Beyaz / White**  
**Siyah / Black**



**Nobel Köşeden Gergi Aksesuar Seti**  
Nobel Corner Tensioner Accessory Set

Koli İçi Adet  
Amount within parcel

100 Set

**AKS 22**  
**AKS 23**

**Beyaz / White**  
**Siyah / Black**

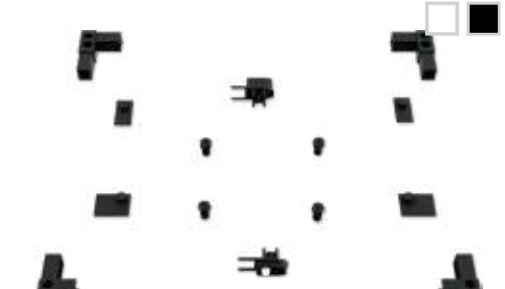

**Nobel Köşeden Gergi Eşiksiz Aksesuar Seti**

Nobel Corner Tensioner Accessory Set without Threshold

Koli İçi Adet  
Amount within parcel

100 Set

Özellikle panjur ve karavan gibi dar alanlar-  
da tercih edilen bir sistemdir. Kasa geniş-  
liği diğer serilere göre daha küçüktür. Bu  
ürünle birlikte panjur sistemlerinde kulla-  
nım imkânı sağlayan slim seriye alternatif  
olarak değerlendirilmektedir.

It is a preferred system, especially in narrow  
areas such as blinds and caravans. The case  
width is smaller than other series. With this  
product, it is considered an alternative to the  
slim series, which provides the opportunity  
to be used in shutter systems.

**335**



**Nobel Kanat Profil**  
Nobel Wing Profile

Paket İçi Adet  
Amount within package

10

Gramajı  
Weight

0,345 kg/m

**336**



**Nobel Eşiksiz Kasa Profil**  
Nobel Case Profile without Threshold

Paket İçi Adet  
Amount within package

10

Gramajı  
Weight

0,148 kg/m

**338**



**Nobel Kasa Profil**  
Nobel Case Profile

Paket İçi Adet  
Amount within package

10

Gramajı  
Weight

0,250 kg/m

**Alüminyum Renk Seçeneği**

Aluminum Color Options

**9016**

Beyaz  
White



Eloksal Boyalı  
Anodized Painted



Bronz Boyalı  
Bronze Painted

**8003**

Altın Meşe  
Golden Oak

**8016**

Maun  
Mahogany

**7016**

Antrasit Gri  
Anthracite Gray

## NOBEL SERİ PLİSE SİNEKLİK / NOBEL SERIES PLEATED FLY SCREEN

### İçten Montajlı Internal Mounted

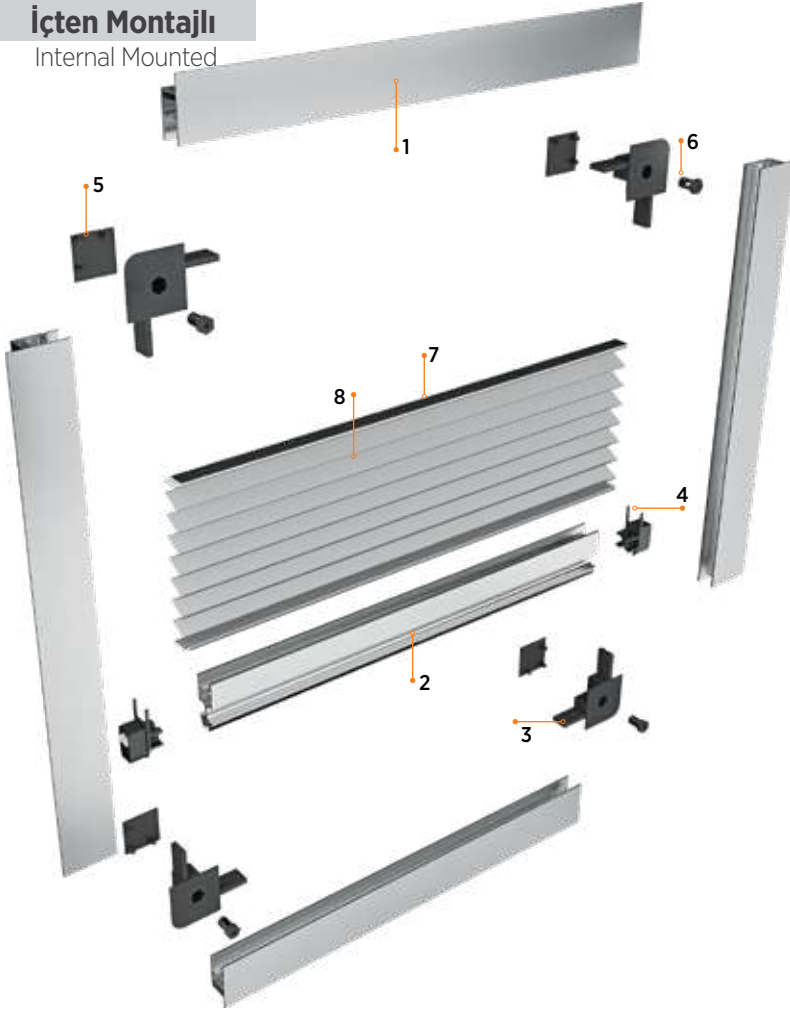

### Yeni Ürün New Product

#### İçten Montaj Set İçeriği / Internal Mounted Set Contents

No	ÜRÜN KODU Product Code	ÜRÜN ADI Product Name
1	337	<b>Nobel İçten Montajlı Kasa</b> Nobel Internal Mounted Case Profile
2	335	<b>Nobel Kanat Profili</b> Nobel Wing
3	-	<b>Nobel İçten Montajlı Köşe Takoğu</b> Nobel Internally Assembled Corner Wedge
4	-	<b>Nobel Rulman Takımı</b> Nobel Bearing Set
5	-	<b>Nobel İçten Montajlı Köşe Takoğu Kapağı</b> Nobel Internal Mounted Corner Wedge Lid
6	-	<b>Nobel Köşe Takoğu Pimi</b> Nobel Corner Wedge Pin
7	-	<b>Plise Şerit</b> Pleat Ribbon
8	-	<b>Plise Tül</b> Pleat Tulle

### PLS 06



#### Nobel Seri Metal Klips Nobel Serial Metal Cleps

Paket İçi Adet Amount within package	500	Koli İçi Adet Amount within parcel	500
---	-----	---------------------------------------	-----

Montaj alanı dar olan Pvc ve panjur sistemleri için kullanılmaktadır. Sistem içerisinde kolay ve hızlı bir şekilde montajlanabilmektedir. İhtiyaç halinde sökülüp takılabileme imkanı sunar.

It is used for PVC and shutter systems with narrow mounting areas. It can be assembled easily and quickly from within the system. It offers the possibility to be disassembled and mounted when needed.



<b>335</b>	
<b>Nobel Kanat Profil</b> Nobel Wing Profile	
Paket İçi Adet Amount within package	10
Gramajı Weight	0,345 kg/m



<b>337</b>	
<b>Nobel İçten Montajlı Kasa Profil</b> Nobel Internal Mounted Case Profile	
Paket İçi Adet Amount within package	10
Gramajı Weight	0,338 kg/m



<b>AKS 20</b> <b>AKS 21</b>	<b>Beyaz / White</b> <b>Siyah / Black</b>
<b>Nobel İçten Montajlı Aksesuar Seti</b> Nobel Internal Mounted Accessory Set	
Koli İçi Adet Amount within parcel	100 Set

### Alüminyum Renk Seçeneği Aluminum Color Options

**9016**

Beyaz  
White



Eloksoal Boyalı  
Anodized Painted



Bronz Boyalı  
Bronze Painted

**8003**

Altın Meşe  
Golden Oak

**8016**

Maun  
Mahogany

**7016**

Antrasit Gri  
Anthracite Gray

**SLIM SERİ İÇTEN MONTAJLI PLİSE SİNEKLİK / SLIM SERIES INTERNAL MOUNTED PLAIT FLY SCREEN**



**Slim İçten Geçmeli Sineklik Profil**  
Slim Internal Mounted Fly Screen Profile

Paket İçi Adet Amount within package	10	Gramajı Weight	0,272 kg/m
---	----	-------------------	------------



**Slim Kanat Profil**  
Slim Wing profile

Paket İçi Adet Amount within package	10	Gramajı Weight	0,303 kg/m
---	----	-------------------	------------



**İçten Montajlı Metal Klips**  
Internal Mounted Metal Clip

Paket İçi Adet Amount within package	500	Koli İçi Adet Amount within parcel	500
---	-----	---------------------------------------	-----



**İçten Montajlı Plise Köşeden Gergi Aksesuar Seti**  
Internal Mounted Pleated Corner Tensioner Accessory Set

Koli İçi Adet Amount within parcel	100 Set
---------------------------------------	---------

**Aksesuar İçeriği / Accessory Contents**

No	ÜRÜN KODU Product Code	ÜRÜN ADI Product Name
1	-	4 adet Köşe Takoza 4 Pieces Corner Wedge
2	-	2 Adet Rulmanlı Hareket Kapağı 2 Pieces Ball Bearing
3	-	2 Adet Köşe Gergi Vidası 2 Pieces Corner Screw
4	-	10 Adet İp Dağıtım Aparatı (Delikli Klips) 10 Pieces Rope Distribution Apparatus (Hole Clip)

**ÖZELLİKLER**  
PROPERTIES

**İçten Takılabilen Plise Sineklik;**  
Internal Mountable Pleated Flyscreen;

Pencere önünde engel olan yerlerde (korkuluk, panjur, çiçeklik, vb.) kullanılır.

Used in areas where there are obstacles in front of windows (railings, window shades, flower beds, etc.).

Yüksek katlarda sinekliğin dışarı açılmasını istemediğiniz durumlarda,

In cases where you don't want the fly screen to be opened on higher floors to the exterior,

Montaj için pencere kasasına herhangi bir vida atılmasını istemediğiniz durumlarda,

If you don't want any screws to be inserted into the window frame for installation,

Bütün olumsuzlukları ortadan kaldıran sineklik sistemidir.

It is a flyscreen systems which eliminates all the problems.

İçten takılabilen sineklik, sabit sineklik olarak vazife görür.

The flyscreens which can be fitted from the inside, serve as fixed flyscreen.

Klips ile takıldığı için montajda vida kullanılmaz. Montajı çok kolaydır.

Screw is not used in the assembly since it is attached with the clip. It is very easy to assemble.

Kolayca sökülerek temizliği yapılabilir.

It can be easily removed and cleaned.



**Alüminyum Renk Seçeneği**

Aluminum Color Options

**9016**

Beyaz  
White



Eloksal Boyalı  
Anodized Painted



Bronz Boyalı  
Bronze Painted

**8003**

Altın Meşe  
Golden Oak

**8016**

Maun  
Mahogany

**7016**

Antrasit Gri  
Anthracite Gray



## İÇTEN MONTAJLI SABİT SİNEKLİK / INTERNAL MOUNTED FIXED FLY SCREEN



<b>Kasa Profil</b> Case Profile			
Paket İçi Adet Amount within package	10	Gramajı Weight	0,256 kg/m



<b>PRS 32</b>	<b>Beyaz / Siyah</b> White / Black		
<b>Köşe Birleştirici Takoz</b> Corner Combiner Wedge			
Paket İçi Adet Amount within package	100	Koli İçi Adet Amount within parcel	500



<b>PRS 33</b>			
<b>İçten Montajlı Metal Klips</b> Internal Mounted Metal Clip			
Paket İçi Adet Amount within package	500	Koli İçi Adet Amount within parcel	500



### ÖZELLİKLER PROPERTIES

#### İçten Takılabilen Sineklik; Internal Mountable Flyscreen;

Pencere önünde engel olan yerlerde (korkuluk, panjur, çiçeklik, vb.) kullanılır.  
Used in areas where there are obstacles in front of windows (railings, window shades, flower beds, etc.).

Yüksek katlarda sinekliğin dışarı açılmasını istemediğiniz durumlarda,  
In cases where you don't want the fly screen to be opened on higher floors to the exterior,

Montaj için pencere kasasına herhangi bir vida atılmasını istemediğiniz durumlarda,  
If you don't want any screws to be inserted into the window frame for installation,

Bütün olumsuzlukları ortadan kaldıran sineklik sistemidir.  
It is a flyscreen systems which eliminates all the problems.

İçten takılabilen sineklik, sabit sineklik olarak vazife görür.  
The flyscreens which can be fitted from the inside, serve as fixed flyscreen.

Klips ile takıldığı için montajda vida kullanılmaz. Montajı çok kolaydır.

Screw is not used in the assembly since it is attached with the clip. It is very easy to assemble.

Kolayca sökülerek temizliği yapılabilir.  
It can be easily removed and cleaned.

#### Alüminyum Renk Seçeneği Aluminum Color Options

**9016**

Beyaz  
White



Eloksal Boyalı  
Anodized Painted



Bronz Boyalı  
Bronze Painted

**8003**

Altın Meşe  
Golden Oak

**8016**

Maun  
Mahogany

**7016**

Antrasit Gri  
Anthracite Gray

ÜRÜN ADI Product Name	ÜRÜN KODU Product Code	Paket m <sup>2</sup> Package m <sup>2</sup>	KOLİ İÇİ ADET (m <sup>2</sup> ) Amount within Parcel (m <sup>2</sup> )
<b>200cm Plise Polyester Tül</b> 200cm Plait Polyester Tulle	200 P	60 m <sup>2</sup>	300 m <sup>2</sup>
<b>210cm Plise Polyester Tül</b> 210cm Plait Polyester Tulle	210 P	63 m <sup>2</sup>	315 m <sup>2</sup>
<b>220cm Plise Polyester Tül</b> 220cm Plait Polyester Tulle	220 P	66 m <sup>2</sup>	330 m <sup>2</sup>
<b>240cm Plise Polyester Tül</b> 240cm Plait Polyester Tulle	240 P	72 m <sup>2</sup>	360 m <sup>2</sup>
<b>270cm Plise Polyester Tül</b> 270cm Plait Polyester Tulle	270 P	81 m <sup>2</sup>	405 m <sup>2</sup>
<b>300cm Plise Polyester Tül</b> 300cm Plait Polyester Tulle	300 P	90 m <sup>2</sup>	450 m <sup>2</sup>

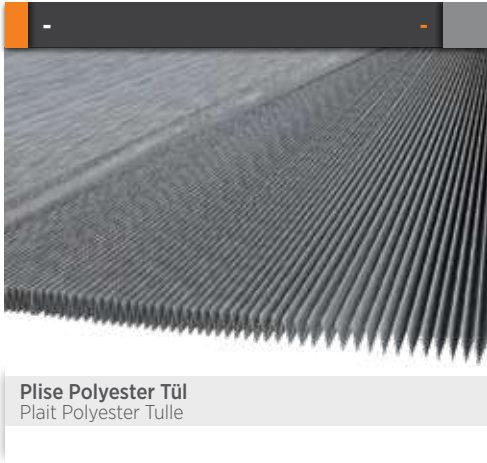

Plise Polyester Tül  
Plait Polyester Tulle

**Pile yüksekliği: 14 mm, 16 mm ve 19 mm ölçülerinde stoklarımızda mevcuttur.**

**A ve B kalitede satışa sunulmaktadır.**

**Plait height:** Available in stock in sizes of 14 mm, 16 mm, and 19 mm.

**Available for sale in A and B quality.**

PLS 12



**Plise İpi**

Pleat Yarn

Paket İçi Adet Amount within package	1 Top * 500 m	Koli İçi Adet Amount within parcel	12
---	---------------	---------------------------------------	----

PLS 52



**PVC Bantlı Şerit 12 mm**

PVC Taped Stripe 12 mm

Paket İçi Adet Amount within package	1 Top * 500 m	Koli İçi Adet Amount within parcel	10
---	---------------	---------------------------------------	----

PLS 50



**PVC Bantlı Şerit 16 mm**

PVC Taped Stripe 16 mm

Paket İçi Adet Amount within package	1 Top * 500 m	Koli İçi Adet Amount within parcel	10
---	---------------	---------------------------------------	----

PLS 51



**PVC Bantlı Şerit 19 mm**

PVC Taped Stripe 19 mm

Paket İçi Adet Amount within package	1 Top * 500 m	Koli İçi Adet Amount within parcel	10
---	---------------	---------------------------------------	----

PLS 14-A



**PVC Yeşil Şerit 16mm**

PVC Green Stripe 16mm

Paket İçi Adet Amount within package	1 Top * 1.400 m
---	-----------------

PLS 14-B



**PVC Yeşil Şerit 19mm**

PVC Green Stripe 19mm

Paket İçi Adet Amount within package	1 Top * 1.000 m
---	-----------------

PLS 14



**PVC Siyah Şerit**

PVC Black Stripe

Paket İçi Adet Amount within package	1 Top * 100 m	Koli İçi Adet Amount within parcel	10
---	---------------	---------------------------------------	----

PLS 53



**Çift Taraflı Bant**

Double Sided Band

Paket İçi Adet Amount within package	1 Top * 50 m	Koli İçi Adet Amount within parcel	10
---	--------------	---------------------------------------	----

PLS 22



**Mıknatıs**

Magnet

Paket İçi Adet Amount within package	16 kg	Koli İçi Adet Amount within parcel	≈175 m
---	-------	---------------------------------------	--------

PRD 08



**Kuş Gözü (Metal) 4 mm**

Rivet (Metal) 4 mm

Koli İçi Adet Amount within parcel	5.000
---------------------------------------	-------

PLS 11



**Kuş Gözü (Metal) - 5 mm**

Rivet (Metal) - 5 mm

Koli İçi Adet Amount within parcel	5.000
---------------------------------------	-------

PRD 31



**Kumaş Delme Makinesi**

Fabric Punching Machine

**PLATİN SÜRME SİNEKLİK / PLATIN SLIDING FLY SCREEN**

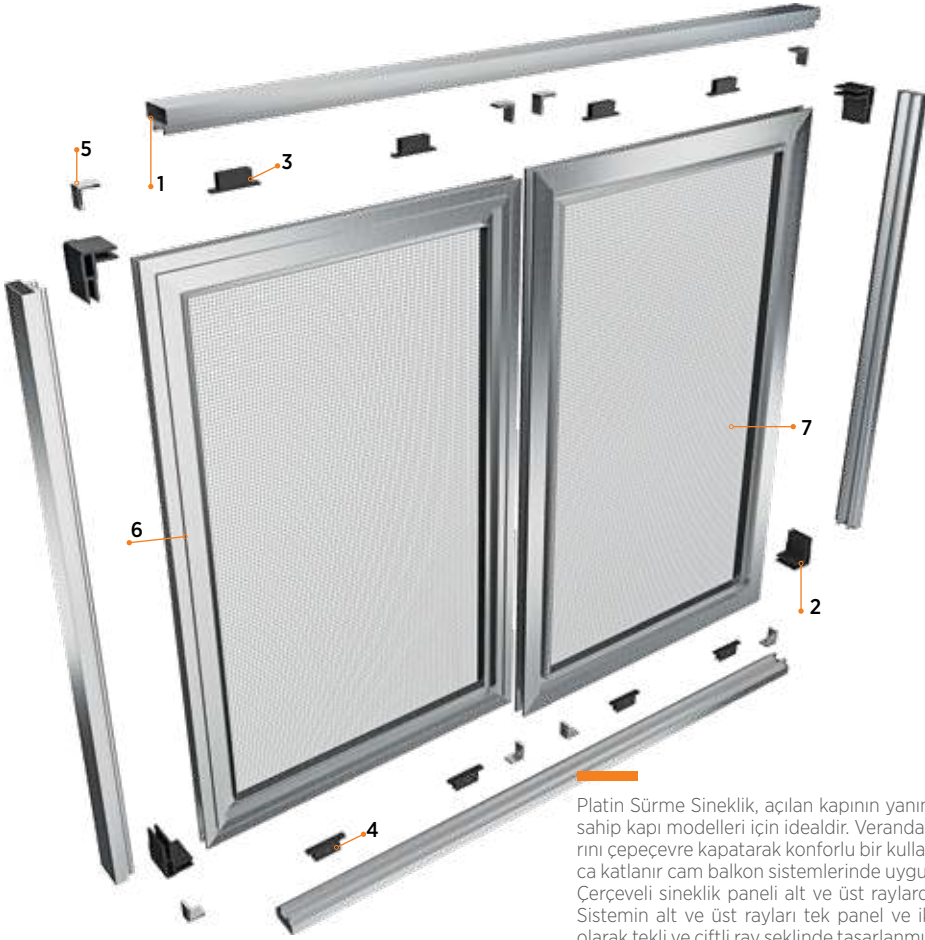

**Platin Set İçeriği / Platin Set Contents**

No	ÜRÜN KODU Product Code	ÜRÜN ADI Product Name
1	321/322	<b>Kasa Profil</b> Case Profile
2	-	<b>Plastik Köşe Takoğu</b> Plastic Corner Wedge
3	-	<b>Denge Plastiği</b> Balance Plastic
4	-	<b>Rulmanlı Teker</b> Bearing Wheel
5	-	<b>Alüminyum Köşe Takoğu</b> Aluminum Corner Wedge
6	323	<b>Kanat Profil</b> Wing Profile
7	-	<b>Sineklik Tülü</b> Flynet Tulle

Platin Sürme Sineklik, açılan kapının yanında sabit panele sahip kapı modelleri için idealdir. Verandaların açık alanlarını çepeçevre kapatarak konforlu bir kullanım sağlar. Ayrıca katlanır cam balkon sistemlerinde uygulanabilmektedir. Çerçevesiz sineklik paneli alt ve üst raylarda çalışmaktadır. Sistemin alt ve üst rayları tek panel ve iki panele uygun olarak tekli ve çiftli ray şeklinde tasarlanmıştır. Bu sistemde bir sineklik paneli max. 200 cm genişlik ve max. 250 cm yükseklikte tavsiye edilmektedir.

Platin Sliding Fly Screen is ideal for door models with fixed panels next to the opening door. It provides comfortable use by covering the open areas of the verandas all around. It can also be applied in folding glass balcony systems. Framed fly screen panel works on the lower and upper rails. The lower and upper rails of the system are designed as single and double rails in accordance with single panels and two panels. In this system, a mosquito net panel is recommended with a max. width of 200 cm and a max. height of 250 cm.



**Platin Seri Aksesuar Seti**  
Platin Serie Accessory Set

Koli İçi Adet  
Amount within parcel

50 Set



**Platin Sürme Sineklik Tekli Kasa**  
Platin Single Case

Paket İçi Adet  
Amount within package

8

Gramajı  
Weight

0,352 kg/m



**Platin Çiftli Kasa**  
Platin Double Case

Paket İçi Adet  
Amount within package

6

Gramajı  
Weight

0,455 kg/m



**Platin Sürme Sineklik Kanat Profil**  
Platin Wing Profile

Paket İçi Adet  
Amount within package

10

Gramajı  
Weight

0,506 kg/m

**Alüminyum Renk Seçeneği**

Aluminum Color Options

**9016**

Beyaz  
White



Eloksoal Boyalı  
Anodized Painted



Bronz Boyalı  
Bronze Painted

**8003**

Altın Meşe  
Golden Oak

**8016**

Maun  
Mahogany

**7016**

Antrasit Gri  
Anthracite Gray

## AYKİM SÜRME SİNEKLİK / AYKİM SLIDING FLY SCREEN

PRS 37

Beyaz / Altın Meşe / Siyah  
White / Golden oak / Black



**Aykim Makarasız Köşe**  
Aykim Corner whitout Roll

Paket İçi Adet Amount within package	50	Koli İçi Adet Amount within parcel	500
---	----	---------------------------------------	-----

PRS 36

Beyaz / Altın Meşe / Siyah  
White / Golden oak / Black



**Aykim Makaralı Köşe**  
Aykim Corner whit Roll

Paket İçi Adet Amount within package	50	Koli İçi Adet Amount within parcel	500
---	----	---------------------------------------	-----

PRS 38

Beyaz / Altın Meşe / Siyah  
White / Golden oak / Black



**Aykim Kasa Takozu**  
Aykim Wedge

Paket İçi Adet Amount within package	100	Koli İçi Adet Amount within parcel	1.000
---	-----	---------------------------------------	-------

309



**Aykim Kasa Profil**  
Aykim Case Profile

Paket İçi Adet Amount within package	8	Gramajı Weight	0,374 kg/m
---	---	-------------------	------------

310



**Aykim Kanat Profil**  
Aykim Wing profile

Paket İçi Adet Amount within package	10	Gramajı Weight	0,315 kg/m
---	----	-------------------	------------



**Alüminyum Renk Seçeneği**

Aluminum Color Options

9016

Beyaz  
White



Eloksal Boyalı  
Anodized Painted



Bronz Boyalı  
Bronze Painted

8003

Altın Meşe  
Golden Oak

8016

Maun  
Mahogany

7016

Antrasit Gri  
Anthracite Gray



Stor Set İçeriği / Stor Set Contents

No	ÜRÜN KODU Product Code	ÜRÜN ADI Product Name
1	409	Üst Kasa Profil Upper Case Profile
2	410	Yan Kasa Profil Side Case Profile
3	411	Alt Kasa Profil Bottom Case Profile
4	407	Kanat Profil Wing Profile
5	408	Tül Boru Profil Tulle Pipe Profile
6	-	Stor Tül Stor Tulle
7	-	Fren Köşe Plastiği Brake Corner Plastic
8	-	Yay Köşe Plastiği Spring Corner Plastic
9	-	Yay Spring
10	-	Yay Kapama Boru Plastiği Spring Closure Pipe Plastic
11	-	Yay Sabitleme Plastiği Spring Fixing Plastic
12	-	Kasa Birleştirme Plastiği Case Joining Plastic
13	-	Kulp Handle
14	-	İp Tutma Aparatı Rope Holder
15	-	Kanat Kapağı Wing Cover
16	-	Fren Sistemi Brake System
17	-	Kıl FİTİL Hair Seal



STR 01

Beyaz / Siyah  
White / Black



**Stor Sineklik Aksesuar Seti**  
Stor Fly Screen Accessory Set

Paket İçi Adet Amount within package	1 Set	Koli İçi Adet Amount within parcel	50 Set
---	-------	---------------------------------------	--------

STR 02

Siyah  
Black



**Stor Sineklik Fren Sistemi**  
Stor Fly Screen Pipe Profile

Paket İçi Adet Amount within package	50	Koli İçi Adet Amount within parcel	50
---	----	---------------------------------------	----

Fitel 22



**67x650 Kıl Fitol**  
67x650 Weatherstrips

Paket İçi Adet Amount within package	350 m	Koli İçi Adet Amount within parcel	1400 m
---	-------	---------------------------------------	--------

STR 03



**Stor Kaset 160 cm**  
Cassette 160 cm

Paket İçi Adet Amount within package	1 Set		
---	-------	--	--

STR 04



**Stor Kaset 240 cm**  
Cassette 240 cm

Paket İçi Adet Amount within package	1 Set		
---	-------	--	--

410



**Stor Sineklik Yan Kasa Profil**  
Stor Fly Screen Side Case Profile

Paket İçi Adet Amount within package	6	Gramajı Weight	0,413 kg/m
---	---	-------------------	------------

411



**Stor Sineklik Alt Kasa Profil**  
Stor Fly Screen Bottom Case Profile

Paket İçi Adet Amount within package	10	Gramajı Weight	0,318 kg/m
---	----	-------------------	------------



- Yay mekanizmalı ve geri sarmalı olarak tasarlandı.
- Alt kasa aynı zamanda sineklik ekranını kilitleyecek şekilde tırnaklı olarak tasarlandı.
- ALüminyum kanat alt kasa tırnaklarından ayrıldığı anda sarım profili içerisindeki kurulmuş olan yay, sineklik tülünü üst kasa içerisinde geri sarım yaparak toplar. Bu toplama esnasında hidrolik fren devreye girer. Böylece sarım yavaş ve düzgün olur.
- Sinekliğin çerçevesini oluşturan profiller aynı zamanda kasa profili olarak dizayn edildi. Üst kasa, yan kasa ve alt kasa profilleri 4 adet takoz ile birleştirildi.
- Sistem kurulur. Köşe takozlarındaki kanallardan yapılan vidalama ile sistem yerine montajlanır. İşte bu kadar basit!

- It is designed with a spring mechanism and rewind.
- The bottom case is also designed with tabs to lock the fly screen.
- As soon as the aluminum wing is separated from the lower case tabs, the spring installed in the winding profile collects the fly net in the upper case by rewinding. During this collection, the hydraulic brake is activated. Thus, the winding is slow and smooth.
- The profiles forming the frame of the fly screen were also designed as frame profiles. Upper case, side case, and lower case profiles were combined with 4 wedges.
- The system is easily installed. The installation is accomplished by screwing through the channels in the corner wedges. That's all it takes!

**Alüminyum Renk Seçeneği**

Aluminum Color Options

9016

Beyaz  
White



Eloksal Boyalı  
Anodized Painted



Bronz Boyalı  
Bronze Painted

8003

Altın Meşe  
Golden Oak

8016

Maun  
Mahogany

7016

Antrasit Gri  
Anthracite Gray



Ahşap  
Wooden

PRS 01



**17x25 Sineklik Köşe Takozu**  
17x25 Flynet Corner Wedge

Paket İçi Adet Amount within package	100	Koli İçi Adet Amount within parcel	1.000
---	-----	---------------------------------------	-------

PRS 02



**17x25 Sineklik Mentеше (Plastik Pimli)**  
17x25 Flynet Plastic Hinge (with Plastic Pin)

Paket İçi Adet Amount within package	100	Koli İçi Adet Amount within parcel	2.000
---	-----	---------------------------------------	-------

PRS 04



**17x25 Sineklik Tutamak**  
17x25 Flynet Handle

Paket İçi Adet Amount within package	100	Koli İçi Adet Amount within parcel	1.500
---	-----	---------------------------------------	-------

PRS 05



**17x25 Sineklik Çıtçı**  
17x25 Flynet Gripper

Paket İçi Adet Amount within package	100	Koli İçi Adet Amount within parcel	2.000
---	-----	---------------------------------------	-------

PRS 06



**17x25 Sineklik Bağlama Pabucu**  
17x25 Flynet Fastening Plate

Paket İçi Adet Amount within package	50	Koli İçi Adet Amount within parcel	500
---	----	---------------------------------------	-----

PRS 07



**10x20 Sineklik Köşe Takozu**  
10x20 Flynet Corner Wedge

Paket İçi Adet Amount within package	100	Koli İçi Adet Amount within parcel	2.500
---	-----	---------------------------------------	-------

PRS 08



**10x20 Sineklik Mentеше (Plastik Pimli)**  
10x20 Flynet Plastic Hinge (with Plastic Pin)

Paket İçi Adet Amount within package	100	Koli İçi Adet Amount within parcel	2.000
---	-----	---------------------------------------	-------

PRS 10



**10x20 Sineklik Tutamak**  
10x20 Flynet Handle

Paket İçi Adet Amount within package	100	Koli İçi Adet Amount within parcel	3.000
---	-----	---------------------------------------	-------

PRS 11



**10x20 Sineklik Çıtçı**  
10x20 Flynet Gripper

Paket İçi Adet Amount within package	100	Koli İçi Adet Amount within parcel	3.000
---	-----	---------------------------------------	-------

PRS 12

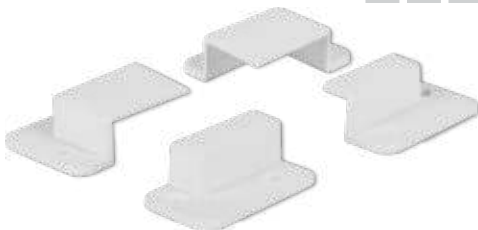

**10x20 Sineklik Bağlama Pabucu**  
10x20 Flynet Fastening Plate

Paket İçi Adet Amount within package	50	Koli İçi Adet Amount within parcel	500
---	----	---------------------------------------	-----

PRS 13



**10x20 Sineklik Tutma Halkası**  
10x20 Flynet Holding Ring

Paket İçi Adet Amount within package	100	Koli İçi Adet Amount within parcel	2.500
---	-----	---------------------------------------	-------

PRS 14



**10x20 Sineklik Tutma Halkası Altı**  
10x20 Flynet Holding Ring Bottom Part

Paket İçi Adet Amount within package	100	Koli İçi Adet Amount within parcel	2.500
---	-----	---------------------------------------	-------



PRS 15



**20x40 Sineklik Köşe Takozu**  
20x40 Flynet Corner Wedge

Paket İçi Adet Amount within package	50	Koli İçi Adet Amount within parcel	600
---	----	---------------------------------------	-----

PRS 16



**10x20 Sineklik Köşe Takozu 45°**  
10x20 Flynet Corner Wedge 45°

Paket İçi Adet Amount within package	100	Koli İçi Adet Amount within parcel	2.000
---	-----	---------------------------------------	-------

PRS 17



**17x25 Sineklik Köşe Takozu 45°**  
17x25 Flynet Corner Wedge 45°

Paket İçi Adet Amount within package	100	Koli İçi Adet Amount within parcel	600
---	-----	---------------------------------------	-----

PRS 26



**Sineklik Köşe Mukavemet Takozu**  
Flynet Corner Strength Wedge

Paket İçi Adet Amount within package	100	Koli İçi Adet Amount within parcel	1.500
---	-----	---------------------------------------	-------

PRS 24



**Plastik "D" Kol**  
Plastic "D" Handle

Paket İçi Adet Amount within package	50	Koli İçi Adet Amount within parcel	600
---	----	---------------------------------------	-----

PRS 30



**Plastik "C" Kol**  
Plastic "C" Handle

Paket İçi Adet Amount within package	100	Koli İçi Adet Amount within parcel	1.500
---	-----	---------------------------------------	-------

PRS 27

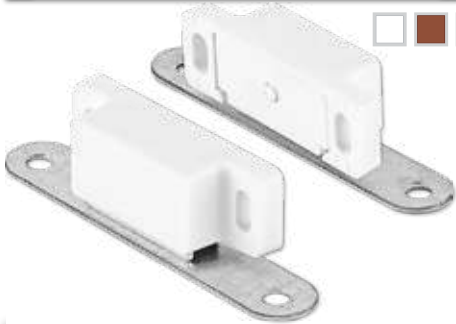

**Mıknatıslı Çıtçı**  
Gripper with Magnet

Paket İçi Adet Amount within package	100	Koli İçi Adet Amount within parcel	500
---	-----	---------------------------------------	-----

PRS 19



**Sineklik Fıtılı (Beyaz)**  
Flynet Seal (White)

Paket İçi Adet Amount within package	15	Koli İçi Adet Amount within parcel	1.500 m
---	----	---------------------------------------	---------

PRS 29



**Sineklik Takma Aparatı 3'lü**  
Triple Flynet Mounting Apparatus

Paket İçi Adet Amount within package	20	Koli İçi Adet Amount within parcel	100
---	----	---------------------------------------	-----

PRS 37



**Aykim Makarasız Köşe**  
Aykim Corner without Pulley

Paket İçi Adet Amount within package	50	Koli İçi Adet Amount within parcel	500
---	----	---------------------------------------	-----

PRS 36



**Aykim Makaralı Köşe**  
Aykim Corner with Pulley

Paket İçi Adet Amount within package	50	Koli İçi Adet Amount within parcel	500
---	----	---------------------------------------	-----

PRS 38



**Aykim Kasa Takozu**  
Aykim Wedge

Paket İçi Adet Amount within package	100	Koli İçi Adet Amount within parcel	1.000
---	-----	---------------------------------------	-------

PRS 25



**Cam Küreği**  
Glass Showed

Koli İçi Adet  
Amount within parcel 150

PRS 20



**Plastik Çarpma**  
Plastic Crash Barrier

Koli İçi Adet  
Amount within parcel 500

ZZ 29



**Emniyet Kilidi**  
Safety Lock

Koli İçi Adet  
Amount within parcel 150

ZZ 32



**Pimli Emniyet Kilidi**  
Safety Lock with Pin

Koli İçi Adet  
Amount within parcel 150

ZZ 39



**Halatlı Emniyet Kilidi**  
Safety Lock with Rope

Koli İçi Adet  
Amount within parcel 100

PSS 8



**Paslanmaz Lüks Teker**  
Stainless Luxury Wheel

Koli İçi Adet  
Amount within parcel 200

ZZ 26



**Teflon Bant**  
Teflon Tape

Koli İçi Adet  
Amount within parcel 50 m

Cam Takozları

Glass Wedges



**ÜRÜN ADI**  
Product Name

**ÜRÜN KODU**  
Product Code

**KOLİ İÇİ ADET**  
Amount within Parcel

İnce Cam Takoza (2mmx20mmx80mm) / Thin Glass Wedge

ACT 6

20.000

Kalın Cam Takoza (Kırılan) (5mmx20mmx80mm) / Thick Glass Wedge Broken One

ACT 7

12.000

Kalın Cam Takoza (Bükülen) (5mmx20mmx80mm) / Thick Glass Wedge Bending

ACT 8

12.000

6000 Cam Takoza Kalın (5mmx25mmx80mm) / Thick Glass Wedge

ACT 9

10.000

Geniş Cam Takoza Kalın (5mmx28mmx80mm) / Wide Glass Wedge Thick

ACT 10

10.000

32'lik Cam Takoza Kalın (5mmx32mmx80mm) / Glass Wedge for Size 32 Thick

ACT 11

5.000

## DESTEK SACLI 90 mm PLASTİK KAPI MENTEŞESİ

90 mm Plastic Door Hinge with Support Sheet

ÜRÜN ADI Product Name	ÜRÜN KODU Product Code	KOLI İÇİ ADET Amount within Parcel
Beyaz 9016 / White 9016	SM 90 9016	150
Altın Meşe 8003 / Golden Oak 8003	SM 90 8003	150
Maun 8016 / Mahogany 8016	SM 90 8016	150
Antrasit Gri 7016 / Anthracite Gray 7016	SM 90 7016	150
Siyah 9005 / Black 9005	SM 90 9005	150



### ÖZELLİKLER

PROPERTIES

1,5 mm galvaniz kaplamalı çelik sac ile desteklenmiştir.  
Supported by 1,5 mm galvanized steel sheet.

İç yapısındaki sac desteği sayesinde zamak menteşelere göre taşıma kapasitesi daha yüksektir.  
Thanks to the sheet metal support in the internal structure higher carrying capacity is given compared to the zamak hinges.

Kanatlarda sarkma problemini tamamen ortadan kaldırır.  
It completely eliminates the problem of sagging in the wings.



1,5 mm galvaniz kaplamalı  
çelik sac (90 mm)

1,5 mm galvanized  
steel sheet (90 mm)

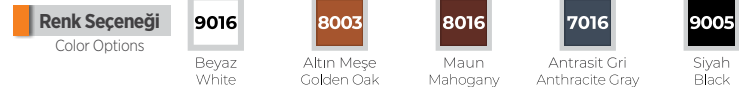

## DESTEK SACLI 75 mm PLASTİK PENCERE MENTEŞESİ

75 mm Plastic Window Hinge with Support Sheet

ÜRÜN ADI Product Name	ÜRÜN KODU Product Code	KOLI İÇİ ADET Amount within Parcel
Beyaz 9016 / White 9016	SM 75 9016	150
Altın Meşe 8003 / Golden Oak 8003	SM 75 8003	150
Maun 8016 / Mahogany 8016	SM 75 8016	150
Antrasit Gri 7016 / Anthracite Gray 7016	SM 75 7016	150
Siyah 9005 / Black 9005	SM 75 9005	150



### ÖZELLİKLER

PROPERTIES

1,2 mm galvaniz kaplamalı çelik sac ile desteklenmiştir.  
Supported by 1,2 mm galvanized steel sheet.

İç yapısındaki sac desteği sayesinde zamak menteşelere göre taşıma kapasitesi daha yüksektir.  
Thanks to the sheet metal support in the internal structure higher carrying capacity is given compared to the zamak hinges.

Kanatlarda sarkma problemini tamamen ortadan kaldırır.  
It completely eliminates the problem of sagging in the wings.



1,2 mm galvaniz kaplamalı  
çelik sac (75 mm)

1,2 mm galvanized  
steel sheet (75 mm)



**Gold Baza Profil**  
Gold Base Profile

Paket İçi Adet Amount within package	3	Gramajı Weight	0,717 kg/m
---	---	-------------------	------------



**Firtına Baza Profil**  
Firtına Base Profile

Paket İçi Adet Amount within package	3	Gramajı Weight	0,730 kg/m
---	---	-------------------	------------



**Oluklu Kasa Profil**  
Corrugated Case Profile

Paket İçi Adet Amount within package	3	Gramajı Weight	1,396 kg/m
---	---	-------------------	------------



**Düz Kasa Profil**  
Flat Case Profile

Paket İçi Adet Amount within package	3	Gramajı Weight	1,355 kg/m
---	---	-------------------	------------



**Oluklu Büyük Kasa Profil**  
Corrugated Big Case Profile

Paket İçi Adet Amount within package	3	Gramajı Weight	1,611 kg/m
---	---	-------------------	------------



**Büyük Düz Kasa Profil**  
Big Flat Case Profile

Paket İçi Adet Amount within package	3	Gramajı Weight	1,570 kg/m
---	---	-------------------	------------



**Dar Yan Dikme Profil**  
Thin Side Column Profile

Paket İçi Adet Amount within package	6	Gramajı Weight	0,441 kg/m
---	---	-------------------	------------



**Geniş Yan Dikme Profil**  
Thick Side Column Profile

Paket İçi Adet Amount within package	6	Gramajı Weight	0,457 kg/m
---	---	-------------------	------------



**Stor Profil**  
Stor Profile

Paket İçi Adet Amount within package	2	Gramajı Weight	1,062 kg/m
---	---	-------------------	------------



**8 mm İspanyolet Profil**  
8 mm Espagnolette Profile

Paket İçi Adet Amount within package	6	Gramajı Weight	0,517 kg/m
---	---	-------------------	------------



**8 mm İspanyolet Profil Karşılığı**  
8 mm Espagnolette Combination Profile

Paket İçi Adet Amount within package	6	Gramajı Weight	0,343 kg/m
---	---	-------------------	------------

# 8mm CAM BALKON FITİL PROFİLLERİ

8mm Balcony Wick Profiles



**Büyük D Fitol**  
Big D Wick

Paket İçi Adet Amount within package	10	Gramajı Weight	0,247 kg/m
---	----	-------------------	------------



**Küçük D Fitol**  
Small D Wick

Paket İçi Adet Amount within package	10	Gramajı Weight	0,167 kg/m
---	----	-------------------	------------

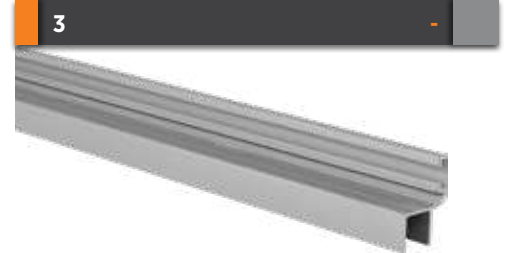

**Küçük h Fitol**  
Small h Wick

Paket İçi Adet Amount within package	20	Gramajı Weight	0,116 kg/m
---	----	-------------------	------------

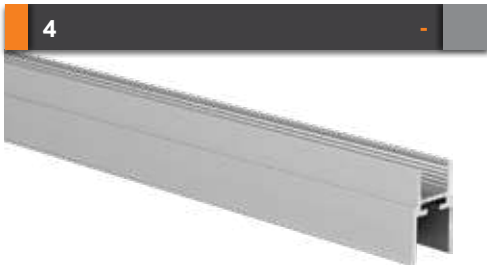

**Orta H Fitol**  
Medium H Wick

Paket İçi Adet Amount within package	20	Gramajı Weight	0,150 kg/m
---	----	-------------------	------------



**Büyük H Fitol**  
Big H Wick

Paket İçi Adet Amount within package	20	Gramajı Weight	0,214 kg/m
---	----	-------------------	------------

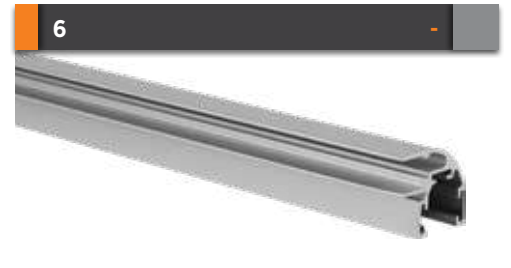

**Köşe Dönüş Fitol**  
Corner Return Wick

Paket İçi Adet Amount within package	10	Gramajı Weight	0,276 kg/m
---	----	-------------------	------------



## Alüminyum Renk Seçeneği

Aluminum Color Options

<b>9016</b>	<b>E6</b>	<b>M0</b>	<b>PO</b>	<b>8003</b>	<b>8016</b>	<b>7016</b>		
Beyaz White	Mat Eloksal Matt Anodized	Mat Bronz Matt Bronze	Parlak Bronz Gloss Bronze	Altın Meşe Golden Oak	Maun Mahogany	Antrasit Gri Anthracite Gray	Eloksal Boyalı Anodized Painted	Bronz Boyalı Bronze Painted

PRC 01

Gold Dıştan Geçmeli Sistem



**Düz Baza Kapak Sağ - Sol**  
Base Intermediate Cover Flat Right-Left

Paket İçi Adet Amount within package	150	Koli İçi Adet Amount within parcel	1.500
---	-----	---------------------------------------	-------

PRC 02

Gold Dıştan Geçmeli Sistem



**Gold Radius Kapak**  
Gold Radius Cover Flat

Paket İçi Adet Amount within package	100	Koli İçi Adet Amount within parcel	600
---	-----	---------------------------------------	-----

PRC 05

Gold Dıştan Geçmeli Sistem



**90° Alt Kapak Sağ - Sol**  
90° Bottom Cover Right-Left

Paket İçi Adet Amount within package	100	Koli İçi Adet Amount within parcel	400
---	-----	---------------------------------------	-----

PRC 06

Gold Dıştan Geçmeli Sistem



**90° Üst Kapak Sağ - Sol**  
90° Top Cover Right-Left

Paket İçi Adet Amount within package	100	Koli İçi Adet Amount within parcel	400
---	-----	---------------------------------------	-----

PRC 09

Gold Dıştan Geçmeli Sistem



**Baza Bitiş Kapak Sağ - Sol**  
Base Side Column Cover Right-Left

Paket İçi Adet Amount within package	100	Koli İçi Adet Amount within parcel	800
---	-----	---------------------------------------	-----

PRC 11

Gold Dıştan Geçmeli Sistem



**22,5° Alt Kapak Sağ - Sol**  
22,5° Bottom Cover Right-Left

Paket İçi Adet Amount within package	100	Koli İçi Adet Amount within parcel	800
---	-----	---------------------------------------	-----

PRC 12

Gold Dıştan Geçmeli Sistem



**22,5° Üst Kapak Sağ - Sol**  
22,5° Top Cover Right-Left

Paket İçi Adet Amount within package	100	Koli İçi Adet Amount within parcel	800
---	-----	---------------------------------------	-----

PRC 01-PİM

Gold Pimli Sistem



**Düz Baza Kapak Pimli Sağ-Sol**  
Base Intermediate Cover Flat with Pin Right-Left

Paket İçi Adet Amount within package	150	Koli İçi Adet Amount within parcel	1.500
---	-----	---------------------------------------	-------

PRC 05-PİM

Gold Pimli Sistem



**90° Alt Kapak Pimli Sağ - Sol**  
90° Bottom Cover with Pin Right-Left

Paket İçi Adet Amount within package	100	Koli İçi Adet Amount within parcel	400
---	-----	---------------------------------------	-----

PRC 06-PİM

Gold Pimli Sistem



**90° Üst Kapak Pimli Sağ - Sol**  
90° Top Cover with Pin Right-Left

Paket İçi Adet Amount within package	100	Koli İçi Adet Amount within parcel	400
---	-----	---------------------------------------	-----

PRC 09-PİM

Gold Pimli Sistem



**Baza Bitiş Kapak Pimli Sağ - Sol**  
Base Side Column Cover with Pin Right-Left

Paket İçi Adet Amount within package	100	Koli İçi Adet Amount within parcel	800
---	-----	---------------------------------------	-----

PRC 11-PİM

Gold Pimli Sistem



**22,5° Alt Kapak Pimli Sağ - Sol**  
22,5° Bottom Cover with Pin Right-Left

Paket İçi Adet Amount within package	100	Koli İçi Adet Amount within parcel	800
---	-----	---------------------------------------	-----

# 8mm CAM BALKON AKSESUARLARI

8mm Balcony Glass Accessories

Renk Seçeneği

Color Options



Siyah  
Black



Gri  
Grey



PRC 12-PİM

Gold Pimli Sistem



22,5° Üst Kapak Pimli Sağ - Sol  
22,5° Top Cover with Pin Right-Left

Paket İçi Adet Amount within package	100	Koli İçi Adet Amount within parcel	800
---	-----	---------------------------------------	-----

PRC 44

Fırtına Sistem



Fırtına Düz Baza Kapak Sağ - Sol  
Fırtına Base Intermediate Cover Flat Right-Left

Paket İçi Adet Amount within package	150	Koli İçi Adet Amount within parcel	1.500
---	-----	---------------------------------------	-------

PRC 46

Fırtına Sistem



Fırtına 90° Alt Kapak Sağ - Sol  
Fırtına 90° Bottom Cover Right-Left

Paket İçi Adet Amount within package	100	Koli İçi Adet Amount within parcel	400
---	-----	---------------------------------------	-----

PRC 47

Fırtına Sistem



Fırtına 90° Üst Kapak Sağ - Sol  
Fırtına 90° Top Cover Right-Left

Paket İçi Adet Amount within package	100	Koli İçi Adet Amount within parcel	400
---	-----	---------------------------------------	-----

PRC 48

Fırtına Sistem



Fırtına Baza Bitiş Kapak Sağ - Sol  
Fırtına Base Side Column Cover Right-Left

Paket İçi Adet Amount within package	100	Koli İçi Adet Amount within parcel	800
---	-----	---------------------------------------	-----

PRC 50

Fırtına Sistem



Fırtına 22,5° Alt Kapak Sağ - Sol  
Fırtına 22,5° Bottom Cover Right-Left

Paket İçi Adet Amount within package	100	Koli İçi Adet Amount within parcel	800
---	-----	---------------------------------------	-----

PRC 51

Fırtına Sistem



Fırtına 22,5° Üst Kapak Sağ - Sol  
Fırtına 22,5° Top Cover Right-Left

Paket İçi Adet Amount within package	100	Koli İçi Adet Amount within parcel	800
---	-----	---------------------------------------	-----

PRC 14



Kilitli Metal Teker  
Locking Wheel with Stainless Pin (Metal)

Paket İçi Adet Amount within package	250	Koli İçi Adet Amount within parcel	250
---	-----	---------------------------------------	-----

PRC 13



Düz Metal Teker  
Plain Wheel with Stainless Pin (Metal)

Paket İçi Adet Amount within package	250	Koli İçi Adet Amount within parcel	250
---	-----	---------------------------------------	-----

PRC 82



8 mm İspanyolet Karşılık Aksesuarı  
8 mm Espagnolette Return Accessory

Paket İçi Adet Amount within package	250	Koli İçi Adet Amount within parcel	1.000
---	-----	---------------------------------------	-------

PRC 32



Plastik Zincir  
Plastic Bead Rope

Paket İçi Adet Amount within package	200 m	Koli İçi Adet Amount within parcel	2.400 m
---	-------	---------------------------------------	---------

PRC 33



Plastik Zincir Tutamağı  
Plastic Bead Rope Handle

Paket İçi Adet Amount within package	700	Koli İçi Adet Amount within parcel	700
---	-----	---------------------------------------	-----

**PRC 17**



**Yönlendirici Boynuz**  
Router

Paket İçi Adet Amount within package	50	Koli İçi Adet Amount within parcel	300
---	----	---------------------------------------	-----

**PRC 18**



**Kilit**  
Lock

Paket İçi Adet Amount within package	100	Koli İçi Adet Amount within parcel	700
---	-----	---------------------------------------	-----

**PRC 26**



**Borulu Stoplama**  
Stopper

Paket İçi Adet Amount within package	150	Koli İçi Adet Amount within parcel	150
---	-----	---------------------------------------	-----

**PRC 22**



**Polyemit Lama 4'lü**  
Guide and Brake for System (4)

Paket İçi Adet Amount within package	200	Koli İçi Adet Amount within parcel	200
---	-----	---------------------------------------	-----

**PRC 23**



**Polyemit Lama 7'li**  
Guide and Brake for System (7)

Paket İçi Adet Amount within package	200	Koli İçi Adet Amount within parcel	200
---	-----	---------------------------------------	-----

**PRC 24**



**Polyemit Lama 10'lü**  
Guide and Brake for System (10)

Paket İçi Adet Amount within package	100	Koli İçi Adet Amount within parcel	100
---	-----	---------------------------------------	-----

**PRC 20**



**Teker Çıkış Plastiği U**  
Outlet Plastics U

Paket İçi Adet Amount within package	100	Koli İçi Adet Amount within parcel	800
---	-----	---------------------------------------	-----

**PRC 79**



**U Çıkış Plastik Kapağı**  
Outlet Plastic Cover U

Paket İçi Adet Amount within package	500	Koli İçi Adet Amount within parcel	500
---	-----	---------------------------------------	-----

**PRC 21**



**Polyemit Lama Tekli**  
Guide and Brake for System

Paket İçi Adet Amount within package	300	Koli İçi Adet Amount within parcel	300
---	-----	---------------------------------------	-----

**PRC 25**



**İnce Yan Dikme Aparatı**  
Thin Side Column Equipment Sys.

Paket İçi Adet Amount within package	150	Koli İçi Adet Amount within parcel	1.500
---	-----	---------------------------------------	-------

**PRC 52**



**Kalın Yan Dikme Aparatı**  
Thick Side Column Equipment Sys.

Paket İçi Adet Amount within package	100	Koli İçi Adet Amount within parcel	600
---	-----	---------------------------------------	-----

**PRC 77**



**Geniş Yan Dikme Aparatı**  
Wide Side Column Equipment Sys.

Paket İçi Adet Amount within package	100	Koli İçi Adet Amount within parcel	600
---	-----	---------------------------------------	-----



# 8mm CAM BALKON AKSESUARLARI

8mm Balcony Glass Accessories

PRC 27



**Alüminyum Köşe Dönüş Takımı**  
Hinged T-square

Paket İçi Adet Amount within package	200	Koli İçi Adet Amount within parcel	200
---	-----	---------------------------------------	-----

PRC 28



**Menteşe Takımı Pim Ayarlı Üst**  
Hinge Up - Adjustable

Paket İçi Adet Amount within package	200	Koli İçi Adet Amount within parcel	200
---	-----	---------------------------------------	-----

PRC 29



**Menteşe Takımı Pim Ayarlı Alt**  
Hinge Bottom - Adjustable

Paket İçi Adet Amount within package	200	Koli İçi Adet Amount within parcel	200
---	-----	---------------------------------------	-----

PRC 30



**Menteşe Takımı Üst**  
Hinge Up

Paket İçi Adet Amount within package	200	Koli İçi Adet Amount within parcel	400
---	-----	---------------------------------------	-----

PRC 31



**Menteşe Takımı Alt**  
Hinge Bottom

Paket İçi Adet Amount within package	200	Koli İçi Adet Amount within parcel	400
---	-----	---------------------------------------	-----

ZZ 126



**İspanyolet Kol**  
Espagnolette Handle

Paket İçi Adet Amount within package	1	Koli İçi Adet Amount within parcel	40
---	---	---------------------------------------	----

ZZ 127



**İspanyolet Slim Kol**  
Espagnolette Slim Handle

Paket İçi Adet Amount within package	1	Koli İçi Adet Amount within parcel	200
---	---	---------------------------------------	-----



800

**Baza Profil**  
Double Glass Base

Paket İçi Adet Amount within package	6	Gramajı Weight	0,618 kg/m
---	---	-------------------	------------



801

**Düz Kapak Profil**  
Double Glass Flat Cover Profile

Paket İçi Adet Amount within package	6	Gramajı Weight	0,321 kg/m
---	---	-------------------	------------



802

**Düz Kapak Mentеше Profil**  
Double Glass Flat Cover with Hinge Profile

Paket İçi Adet Amount within package	6	Gramajı Weight	0,327 kg/m
---	---	-------------------	------------



803

**45° Dönüş Profil**  
45° Return Profile

Paket İçi Adet Amount within package	6	Gramajı Weight	0,445 kg/m
---	---	-------------------	------------



804

**22,5° Dönüş Profil**  
22,5° Return Profile

Paket İçi Adet Amount within package	6	Gramajı Weight	0,378 kg/m
---	---	-------------------	------------



805

**11° Dönüş Profil**  
11° Return Profile

Paket İçi Adet Amount within package	6	Gramajı Weight	0,366 kg/m
---	---	-------------------	------------

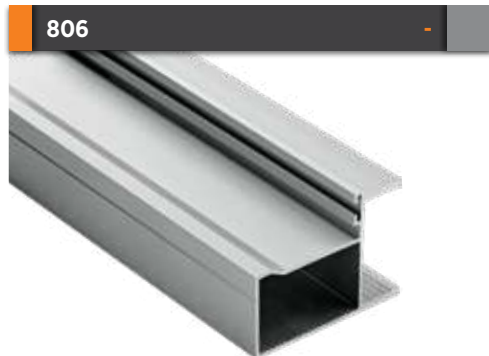

806

**90° Dönüş Profil**  
90° Return Profile

Paket İçi Adet Amount within package	6	Gramajı Weight	0,475 kg/m
---	---	-------------------	------------



807

**Açılı Dönüş Mentеше Profil**  
PopUp Return Hinge Profile

Paket İçi Adet Amount within package	6	Gramajı Weight	0,346 kg/m
---	---	-------------------	------------



808

**Isıcam Yan Dikme Profil**  
Double Glass Side Column Profile

Paket İçi Adet Amount within package	6	Gramajı Weight	0,369 kg/m
---	---	-------------------	------------



809

**Sabit Cam Mentеше Profil**  
Stable Glass Hinge Profile

Paket İçi Adet Amount within package	6	Gramajı Weight	0,328 kg/m
---	---	-------------------	------------



810

**Sabit Cam (Tijli) Kilit Profil**  
Stable Glass Lock Profile

Paket İçi Adet Amount within package	6	Gramajı Weight	0,355 kg/m
---	---	-------------------	------------



811

**Sabit Cam (Tijli) Kilit Karşılık Profil**  
Stable Glass Lock Combination Profile

Paket İçi Adet Amount within package	6	Gramajı Weight	0,342 kg/m
---	---	-------------------	------------

# ISICAMLI CAM BALKON PROFİLLERİ

Glazed with Thermopane Glass Balcony Profiles

819



**Düz Kasa Üstten Fitilli Profil**  
Flat Case Top Wicked Profile

Paket İçi Adet Amount within package	3	Gramajı Weight	1,344 kg/m
---	---	-------------------	------------

820



**Oluklu Kasa Üstten Fitilli Profil**  
Corrugated Case Top Wicked Profile

Paket İçi Adet Amount within package	3	Gramajı Weight	1,389 kg/m
---	---	-------------------	------------

822



**Açılır Dikme Profil**  
PopUp Column Profile

Paket İçi Adet Amount within package	6	Gramajı Weight	0,378 kg/m
---	---	-------------------	------------

816



**Üstten Fitilli Büyük Oluklu Kasa**  
Large Corrugated Case with Top Wick

Paket İçi Adet Amount within package	3	Gramajı Weight	1,577 kg/m
---	---	-------------------	------------

817



**Üstten Fitilli Büyük Düz Kasa**  
Large Flat Case with Wed from Top

Paket İçi Adet Amount within package	3	Gramajı Weight	1,532 kg/m
---	---	-------------------	------------

815



**Tij Profil**  
Espagnolette Profile

Paket İçi Adet Amount within package	10	Gramajı Weight	0,100 kg/m
---	----	-------------------	------------

823



**Isıcam Geniş Yan Dikme**  
Double Glass Wide Side Column

Paket İçi Adet Amount within package	6	Gramajı Weight	0,459 kg/m
---	---	-------------------	------------

824



**Sabit Cam İspanyolet Profil**  
Fixed Glass Espagnolette Profile

Paket İçi Adet Amount within package	6	Gramajı Weight	0,583 kg/m
---	---	-------------------	------------

825



**Sabit Cam İspanyolet Karşılık Profil**  
Fixed Glass Espagnolette Handle Provision Profile

Paket İçi Adet Amount within package	6	Gramajı Weight	0,356 kg/m
---	---	-------------------	------------

## Alüminyum Renk Seçeneği

Aluminum Color Options

9016

Beyaz  
White

E6

Mat Eloksal  
Matt Anodized

M0

Mat Bronz  
Matt Bronze

PO

Parlak Bronz  
Gloss Bronze

8003

Altın Meşe  
Golden Oak

8016

Maun  
Mahogany

7016

Antrasit Gri  
Anthracite Gray

Eloksal Boyalı

Anodized Painted

Bronz Boyalı

Bronze Painted

ZZ 126



**İspanyolet Kol**  
Espagnolette Handle

Paket İçi Adet Amount within package	1	Koli İçi Adet Amount within parcel	40
---	---	---------------------------------------	----

ZZ 127



**İspanyolet Slim Kol**  
Espagnolette Slim Handle

Paket İçi Adet Amount within package	1	Koli İçi Adet Amount within parcel	200
---	---	---------------------------------------	-----

PRC 68



**Eksenel Kol**  
Double Glass Axial Handle

Paket İçi Adet Amount within package	1	Koli İçi Adet Amount within parcel	10
---	---	---------------------------------------	----

PRC 76



**Kilit Karşılık (Metal)**  
Double Glass Lock Provision (Metal)

Paket İçi Adet Amount within package	100	Koli İçi Adet Amount within parcel	400
---	-----	---------------------------------------	-----

PRC 63



**Bağlantı Adaptörü**  
Double Glass Connection Adapter

Paket İçi Adet Amount within package	100	Koli İçi Adet Amount within parcel	400
---	-----	---------------------------------------	-----

PRC 65



**Destek Takozu**  
Double Glass Bracket Wedge

Paket İçi Adet Amount within package	100	Koli İçi Adet Amount within parcel	400
---	-----	---------------------------------------	-----

PRC 75



**Sistem Tij Pimi**  
System Rod Pin

Paket İçi Adet Amount within package	100	Koli İçi Adet Amount within parcel	200
---	-----	---------------------------------------	-----

PRC 73



**Isı Cam EPDM Kauçuk Fitol Çift Conta**  
Double Glass EPDM Rubber Wick Double Gasket

Paket İçi Adet Amount within package	1 Top (10 kg)	Koli İçi Adet Amount within parcel	125 m
---	---------------	---------------------------------------	-------

PRC 74



**Isı Cam EPDM Kauçuk Fitol Tek Conta**  
Double Glass EPDM Rubber Wick Single Gasket

Paket İçi Adet Amount within package	1 Top (10 kg)	Koli İçi Adet Amount within parcel	290 m
---	---------------	---------------------------------------	-------

**Alüminyum Renk Seçeneği**

Aluminum Color Options

<b>9016</b> Beyaz White	<b>E6</b> Mat Eloksal Matt Anodized	<b>M0</b> Mat Bronz Matt Bronze	<b>P0</b> Parlak Bronz Gloss Bronze
<b>8003</b> Altın Meşe Golden Oak	<b>8016</b> Maun Mahogany	<b>7016</b> Antrasit Gri Anthracite Gray	Eloksal Boyalı Anodized Painted
			Bronz Boyalı Bronze Painted

210



**Sürme Baza Profil**  
Sliding Base Profile

Paket İçi Adet Amount within package	4	Gramajı Weight	0,643 kg/m
---	---	-------------------	------------

215



**Çekme Kol Profil**  
Pull Handle Profile

Paket İçi Adet Amount within package	3	Gramajı Weight	0,908 kg/m
---	---	-------------------	------------

212



**Kenet Profil**  
Clamp Profile

Paket İçi Adet Amount within package	6	Gramajı Weight	0,423 kg/m
---	---	-------------------	------------

211



**Birleştirme Karşılık Profil**  
Combination Provisions Profile

Paket İçi Adet Amount within package	6	Gramajı Weight	0,301 kg/m
---	---	-------------------	------------

213



**İkili Eşikli Alt Kasa Profil**  
Double Threshold Lower Case Profile

Paket İçi Adet Amount within package	4	Gramajı Weight	0,974 kg/m
---	---	-------------------	------------

222



**Üçlü Eşikli Alt Kasa Profil**  
Triple Threshold Lower Case Profile

Paket İçi Adet Amount within package	2	Gramajı Weight	1,333 kg/m
---	---	-------------------	------------

220



**Üçlü Eşiksiz Alt Kasa Profil**  
Triple Bottom Case Profile without Threshold

Paket İçi Adet Amount within package	4	Gramajı Weight	0,867 kg/m
---	---	-------------------	------------

229



**İkili Üst Kasa Profil**  
Double Upper Case Profile

Paket İçi Adet Amount within package	3	Gramajı Weight	1,120 kg/m
---	---	-------------------	------------

230



**İkili Üçlü Kasa Profil**  
Triple Upper Case Profile

Paket İçi Adet Amount within package	2	Gramajı Weight	0,301 kg/m
---	---	-------------------	------------

221



**Dörtlü Eşiksiz Alt Kasa Profil**  
Quadruple Bottom Case Profile without Threshold

Paket İçi Adet Amount within package	2	Gramajı Weight	1,156 kg/m
---	---	-------------------	------------

214



**İkili Yan Kasa Profil**  
Double Side Case Profile

Paket İçi Adet Amount within package	4	Gramajı Weight	0,587 kg/m
---	---	-------------------	------------

223



**Üçlü Yan Kasa Profil**  
Triple Side Case Profile

Paket İçi Adet Amount within package	2	Gramajı Weight	0,792 kg/m
---	---	-------------------	------------

219 Tek cam adaptörü/ Single glass adapter



8 mm Cam Adaptörü  
8 mm Glass Adapter

Paket İçi Adet Amount within package	10	Gramajı Weight	0,219 kg/m
---	----	-------------------	------------

226



Kapatma Profil  
Closing Profile

Paket İçi Adet Amount within package	10	Gramajı Weight	0,071 kg/m
---	----	-------------------	------------

227



İspanyollet Çekme Kol Profili  
Espagnolette Pull Handle Profile

Paket İçi Adet Amount within package	4	Gramajı Weight	0,957 kg/m
---	---	-------------------	------------

228



İspanyollet Karşılık Profili  
Espagnolette Provision Profile

Paket İçi Adet Amount within package	10	Gramajı Weight	0,156 kg/m
---	----	-------------------	------------



PSS 1

Siyah  
Black



**Çekme Kol Profil Aksesuarı**  
Sliding Profile Plastic

Paket İçi Adet Amount within package	50	Koli İçi Adet Amount within parcel	200
---	----	---------------------------------------	-----

PSS 2

Siyah  
Black



**Kenet Profil Aksesuarı - Üst**  
Tensile Profile Plastic Top

Paket İçi Adet Amount within package	50	Koli İçi Adet Amount within parcel	200
---	----	---------------------------------------	-----

PSS 3

Siyah  
Black



**Kenet Profil Aksesuarı - Alt**  
Tensile Profile Plastic Bottom

Paket İçi Adet Amount within package	50	Koli İçi Adet Amount within parcel	200
---	----	---------------------------------------	-----

PSS 4

Siyah  
Black



**İspanyollet Çekme Kol Aksesuarı**  
Espagnolette Pull Handle Accessory

Paket İçi Adet Amount within package	50	Koli İçi Adet Amount within parcel	200
---	----	---------------------------------------	-----

PSS 5

Siyah  
Black



**İkili Köşe Takoğu**  
Double Corner Wedge

Paket İçi Adet Amount within package	50	Koli İçi Adet Amount within parcel	200
---	----	---------------------------------------	-----

PSS 6

Siyah  
Black



**Üçlü Köşe Takoğu**  
Triple Corner Wedge

Paket İçi Adet Amount within package	50	Koli İçi Adet Amount within parcel	200
---	----	---------------------------------------	-----

PSS 7

Siyah  
Black



**Vida Tapası**  
Screw Plug

Koli İçi Adet Amount within parcel	2.000
---------------------------------------	-------

PSS 12

Siyah  
Black



**Sürme Yalıtım Aksesuarı**  
Sliding Insulation Accessory

Koli İçi Adet Amount within parcel	200
---------------------------------------	-----

PSS 8



**Paslanmaz Lüks Teker**  
Stainless Luxury Wheel

Koli İçi Adet Amount within parcel	200
---------------------------------------	-----

PSS 9



**Havuz Kol (Kilitsiz)**  
Hole Handle (Unlocked)

Paket İçi Adet Amount within package	1	Koli İçi Adet Amount within parcel	1
---	---	---------------------------------------	---

PSS 10



**Klips Kol**  
Clasp Handle

Paket İçi Adet Amount within package	1	Koli İçi Adet Amount within parcel	1
---	---	---------------------------------------	---

PSS 11



**Kale 201 F (Horoz) Kilit**  
Kale 201 F (Pin) Lock

Paket İçi Adet Amount within package	1	Koli İçi Adet Amount within parcel	1
---	---	---------------------------------------	---



140

**Sabit Panel Açılır Alt Baza Profil**  
Fixed Panel Pop-up Base Profile

Paket İçi Adet Amount within package	6	Gramajı Weight	0,563 kg/m
---	---	-------------------	------------



164

**Sabit Panel Yan Dikme Profil**  
Fixed Panel Side Column Profile

Paket İçi Adet Amount within package	4	Gramajı Weight	0,842 kg/m
---	---	-------------------	------------



142

**Sabit Panel Üst Baza Profil**  
Fixed Panel Top Base Profile

Paket İçi Adet Amount within package	4	Gramajı Weight	0,750 kg/m
---	---	-------------------	------------



167

**Kenet Baza Profil**  
Clamp Base Profile

Paket İçi Adet Amount within package	4	Gramajı Weight	1,144 kg/m
---	---	-------------------	------------



144

**Hareketli Panel Yan Dikme Profil**  
Movable Panel Side Column Profile

Paket İçi Adet Amount within package	6	Gramajı Weight	0,434 kg/m
---	---	-------------------	------------



145

**Kúpeşte Baza Profil**  
Handrail Base Profile

Paket İçi Adet Amount within package	6	Gramajı Weight	0,579 kg/m
---	---	-------------------	------------



146

**Hareketli Panel Açılır Alt Baza Profil**  
Movable Panel Pop-up Lower Base Profile

Paket İçi Adet Amount within package	4	Gramajı Weight	0,741 kg/m
---	---	-------------------	------------



161

**Ray Kapatma "T" Profil**  
Rail Closure "T" Profile

Paket İçi Adet Amount within package	4	Gramajı Weight	0,482 kg/m
---	---	-------------------	------------



160

**Yan Ray "T" Profil**  
Side Rail "T" Profile

Paket İçi Adet Amount within package	2	Gramajı Weight	1,057 kg/m
---	---	-------------------	------------



166

**Açılımlı için Ray Kapatma 'L' Profil**  
Rail Closure 'L' Profile for Opening

Paket İçi Adet Amount within package	10	Gramajı Weight	0,144 kg/m
---	----	-------------------	------------



162

**Yan Ray "L" Profil**  
Side Rail "L" Profile

Paket İçi Adet Amount within package	4	Gramajı Weight	0,703 kg/m
---	---	-------------------	------------



GYT 28

**Et Kalınlığı 1,2 mm**  
wall thickness 1,2 mm

**Sac Tambur Borusu**  
Sheet Drum Pipe

Paket İçi Adet Amount within package	1	Boy Length	7 m
---	---	---------------	-----





152

**Alt Kasa Profil**  
Lower Case Profile

Paket İçi Adet Amount within package	2	Gramajı Weight	1,563 kg/m
---	---	-------------------	------------



156

**Üst Kasa Profil**  
Top Case Profile

Paket İçi Adet Amount within package	1	Gramajı Weight	3,449 kg/m
---	---	-------------------	------------



153

**Üst Kasa Kapak Profil**  
Top Case Cover Profile

Paket İçi Adet Amount within package	2	Gramajı Weight	0,864 kg/m
---	---	-------------------	------------



155

**Yan Kasa Profil**  
Side Case Profile

Paket İçi Adet Amount within package	2	Gramajı Weight	1,669 kg/m
---	---	-------------------	------------



154

**Küpeşte Profil**  
Handrail Profile

Paket İçi Adet Amount within package	2	Gramajı Weight	0,759 kg/m
---	---	-------------------	------------



165

**Yan Kasa Kertme Profil**  
Side Case Notched Profile

Paket İçi Adet Amount within package	4	Gramajı Weight	0,644 kg/m
---	---	-------------------	------------



158

**Açılımsız Tek Fital Yan Ray L Kasa Profil**  
Single Weatherstrips Without Opening Side L Case Profile

Paket İçi Adet Amount within package	4	Gramajı Weight	0,510 kg/m
---	---	-------------------	------------



159

**Açılımsız Çift Fital Yan Ray L Kasa Profil**  
Double Weatherstrips Without Opening Side L Case Profile

Paket İçi Adet Amount within package	4	Gramajı Weight	0,660 kg/m
---	---	-------------------	------------



219

**Tek Cam Adaptörü/ Single Glass Adapter**

**8 mm Cam Adaptörü**  
8mm Glass Adapter

Paket İçi Adet Amount within package	10	Gramajı Weight	0,219 kg/m
---	----	-------------------	------------



149

**Açılımsız için Ray Kapatma 'L' Profil**  
Rail Closure 'L' Profile for Non-Opening

Paket İçi Adet Amount within package	10	Gramajı Weight	0,162 kg/m
---	----	-------------------	------------

### Alüminyum Renk Seçeneği

Aluminum Color Options



9016  
Beyaz  
White



E6  
Mat Eloksoal  
Matt Anodized



MO  
Mat Bronz  
Matt Bronze



8003  
Altın Meşe  
Golden Oak



8016  
Maun  
Mahogany



7016  
Antrasit Gri  
Anthracite Gray



9005  
Siyah  
Black

GYT 1

Siyah  
Black



**Küpeste Baza Profil Aksesuarı**  
Handrail Base Profile Accessories

Koli İçi Adet  
Amount within parcel 100

GYT 2

Siyah  
Black



**Sabit Panel Aksesuar - Alt**  
Fixed Panel Accessory - Bottom

Koli İçi Adet  
Amount within parcel 100

GYT 3 A

Siyah  
Black



**Kenet Kapak Profil - Sağ / Sol - 146**  
Clamp Profile Plastics - Right / Left - 146

Koli İçi Adet  
Amount within parcel 200

GYT 3 B

Siyah  
Black



**Kenet Kapak Profil - Sağ / Sol - 167**  
Clamp Profile Plastics - Right / Left - 167

Koli İçi Adet  
Amount within parcel 400

GYT 4



**Oluklu Köşe Takozu**  
Corrugated Corner Wedge

Koli İçi Adet  
Amount within parcel 50

GYT 5



**Köşe Takozu**  
Corner Wedge

Koli İçi Adet  
Amount within parcel 100

GYT 6

Siyah  
Black



**Üst Kasa Rulmanlı Kapak**  
Top Case Bearing Cover

Koli İçi Adet  
Amount within parcel 20

GYT 7

Siyah  
Black



**Üst Kasa Motor Bağlantı Kapak**  
Top Case Engine Connection Cover

Koli İçi Adet  
Amount within parcel 20

GYT 8

Siyah  
Black



**Yan Kasa Köşe Birleştirme Takozu**  
Side Case Corner Joint Plastic

Koli İçi Adet  
Amount within parcel 100

GYT 9

Siyah  
Black



**Küpeste Kapağı - Sağ / Sol**  
Handrail Cover - Right / Left

Koli İçi Adet  
Amount within parcel 200

GYT 10

Siyah  
Black



**Zincir Kapama Aksesuar Sağ/Sol**  
Chain Cover Accessory - Right / Left

Koli İçi Adet  
Amount within parcel 200

GYT 11

Siyah  
Black



**Çift Açılır Sabit Panel Aksesuar Üst - Sağ/Sol**  
Double Open Fixed Panel Accessory Top - Right/Left

Koli İçi Adet  
Amount within parcel 200

GYT 27

Siyah  
Black



**Açılımsız Sabit Panel Aksesuar - Alt**  
Fixed Panel Accessory without Opening - Bottom

Koli İçi Adet  
Amount within parcel 100

GYT 12



**Giyoitin Makası**  
Guillotine Junction

Koli İçi Adet  
Amount within parcel 6 Set/Sets

GYT 13

Siyah  
Black



**Orta Panel Çeliđi**  
Center Panel Steel

Koli İçi Adet  
Amount within parcel 40

GYT 14

Siyah  
Black



**Kilit Takımı**  
Lock Set

Koli İçi Adet  
Amount within parcel 100

GYT 15

Siyah  
Black



**Zincir Bađlantı Elemanı**  
Chain Connector

Koli İçi Adet  
Amount within parcel 40

GYT 16



**Tekerli Bađlantı Elemanı**  
Wheel Connector

Koli İçi Adet  
Amount within parcel 80

GYT 17

Siyah  
Black



**Panel Hizalama - Sađ/Sol**  
Panel Aligning - Right/Left

Koli İçi Adet  
Amount within parcel 100

GYT 19



**Tambur Bađlantı Elemanı**  
Drum Connector

Koli İçi Adet  
Amount within parcel 20

GYT 20



**Zincir Diđli**  
Sprocket

Koli İçi Adet  
Amount within parcel 20

GYT 18

Siyah  
Black



**Zincir Yönlendirici**  
Chain Router

Koli İçi Adet  
Amount within parcel 100

GYT 21



**Zincir**  
Chain

Koli İçi Adet  
Amount within parcel 1 (5 m)

GYT 25



**Zincir Ađırlık**  
Chain Weight

Koli İçi Adet  
Amount within parcel 16

**GYT 26**

**Siyah**  
Black



**Sabit Panel Sızdırmazlık Contası**  
Fixed Panel Sealing Gasket

Koli İçi Adet  
Amount within parcel

200 m

**GYT 30**

**Siyah**  
Black



**Üst Kasa Balon Conta**  
Top Case Balloon Gasket

Koli İçi Adet  
Amount within parcel

100 m

**GYT 31**

**Somfy**



**Giyotin Motor (120Nm)**  
Guillotine Engine (120Nm)

Koli İçi Adet  
Amount within parcel

1

**KMD 1**

**Somfy**



**Motor Kumandası (tekli)**  
Engine Remote Control (mono)

Koli İçi Adet  
Amount within parcel

1

**KMD 2**

**Somfy**



**Motor Kumandası (çoklu)**  
Engine Remote Control (multi)

Koli İçi Adet  
Amount within parcel

1

**GYT 32**

**A-OK**

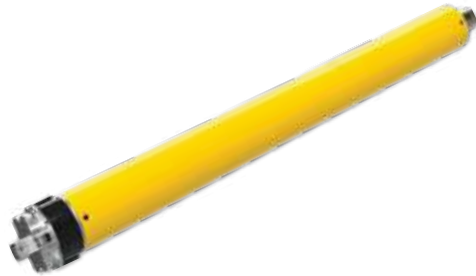

**Giyotin Motor (120Nm)**  
Guillotine Engine (120Nm)

Koli İçi Adet  
Amount within parcel

1

**KMD 3**

**A-OK**



**Motor Kumandası (tekli)**  
Engine Remote Control (mono)

Koli İçi Adet  
Amount within parcel

1

**KMD 4**

**A-OK**



**Motor Kumandası (çoklu)**  
Engine Remote Control (multi)

Koli İçi Adet  
Amount within parcel

1





**417**

**Sonlandırıcı Cam Çıta Kapak Profili**  
End Cap Glass Strip Cover Profile

Paket İçi Adet Amount within package	6	Gramajı Weight	0,467 kg/m
---	---	-------------------	------------



**418**

**Cam Çıta Kapak Profili**  
Glass Strip Cover Profile

Paket İçi Adet Amount within package	10	Gramajı Weight	0,329 kg/m
---	----	-------------------	------------



**419**

**Orta Kayıt Profili**  
Center Mullion Profile

Paket İçi Adet Amount within package	2	Gramajı Weight	2,100 kg/m
---	---	-------------------	------------



**420**

**Kasa Kapatma Profili**  
Frame Closure Profile

Paket İçi Adet Amount within package	4	Gramajı Weight	0,682 kg/m
---	---	-------------------	------------



**421**

**Ayak Profili**  
Leg Profile

Paket İçi Adet Amount within package	1	Gramajı Weight	3,184 kg/m
---	---	-------------------	------------



**422**

**Oluk Profili**  
Groove Profile

Paket İçi Adet Amount within package	1	Gramajı Weight	4,318 kg/m
---	---	-------------------	------------



**423**

**Destekli Orta Kayıt Profili**  
Reinforced Center Mullion Profile

Paket İçi Adet Amount within package	1	Gramajı Weight	3,142 kg/m
---	---	-------------------	------------



**424**

**Duvar Kasa Profili**  
Wall Frame Profile

Paket İçi Adet Amount within package	1	Gramajı Weight	2,835 kg/m
---	---	-------------------	------------



**425**

**Cam Çıtası Profili**  
Glass Strip Profile

Paket İçi Adet Amount within package	4	Gramajı Weight	0,847 kg/m
---	---	-------------------	------------

**Alüminyum Renk Seçeneği**

Aluminum Color Options

**7016**

Antrasit Gri  
Anthracite Gray

**9005**

Siyah  
Black

CT 01

Siyah  
Black



Orta Kayıt Plastik Kapak  
Middle Mullion Plastic Cover

Koli İçi Adet  
Amount within parcel 60

CT 02

Siyah  
Black



Ayak Profili Sabitleme Aksesuarı  
Leg Profile Fixing Accessory

Koli İçi Adet  
Amount within parcel 20

CT 03

Siyah  
Black



Metal Oluk Kasa Kapak  
Metal Gutter Box Cover

Koli İçi Adet  
Amount within parcel 20

CT 04

Siyah  
Black



Metal Duvar Kasa Kapak  
Metal Wall Casing Cover

Koli İçi Adet  
Amount within parcel 20

CT 05

Siyah  
Black



Oluklu Kasa Bağlantı Aksesuarı  
Corrugated Box Connection Accessory

Koli İçi Adet  
Amount within parcel 100

CT 06

Siyah  
Black



Duvar Kasa Bağlantı Aksesuarı  
Wall Casing Connection Accessory

Koli İçi Adet  
Amount within parcel 100

CT 07

Siyah  
Black



Orta Kayıt Contası  
Middle Mullion Gasket

Koli İçi Adet  
Amount within parcel 200 mt

CT 08

Siyah  
Black



Cam Çita Contası  
Glass Strip Gasket

Koli İçi Adet  
Amount within parcel 140 mt

CT 09

Siyah  
Black



Oluk Kasa Yalıtım Yaprak Contası  
Gutter Box Insulation Leaf Gasket

Koli İçi Adet  
Amount within parcel 85 mt

CT 10

Siyah  
Black



Duvar Kasa Yalıtım Yaprak Contası  
Wall Casing Insulation Leaf Gasket

Koli İçi Adet  
Amount within parcel 55 mt

## Plise Perde

Perdecilik sektörünün teknolojik gelişmelere paralel olarak sürekli bir ilerleme göstermesinin sonucunda tüm mekanlarda kullanılabilecek yeni nesil perde sistemleri geliştirerek müşterilerimizin konforunu sağlamayı hedefliyoruz. Klasik perde kumaşlarından farklı olarak güneş ışınlarını filtrelemek, mekanlarda ısı dengesini sağlamak gibi işlevleri olan teknik kumaşlardan yapılan modern perde modellerinin kullanımı giderek daha yaygın hale geliyor. İple kontrol edilenlerinin yanında motorlu alternatifleri de olan plise perde modelleri özellikle modern tarzda dekore edilmiş mekanlara çok iyi uyum sağlıyor.

## Özellikleri

Plise perde sistemlerinin katlanır cam balkonlar, geometrik pencereler PVC pencere ve kapılar için çözüm odaklı olduğunu söylesek yanılmış olmayız. Aynı zaman da sürekli olarak ulaşılması zor noktalar için de başarılı çözümler geliştirmiştir. Yarı geçirgen yapısı sayesinde aydınlık ortamlar yaratır.

Katlanır cam balkon sistemlerinde, PVC pencere ve kapılarda, Winter Garden(Kış Bahçesi) Sistemlerde, yat, tekne, tavan perdeleri, çatı perdesi, eğimli ve geometrik pencereler vs. uygulamalarda kullanılmaktadır. Motorlu ve kumandalı sistemlerinde çok rahatlıkla uygulandığı modeller arasındadır.

Yıkabilen, silinebilen özelliği ile plise perde sistemleri kolay kullanım sağlar. Aynı zaman da alev almama özelliği ile de sağlıklı ortamlar yaratır.



## Mekanlarda Sade ve Modern Bir Görünüm

Plise perdelerin görünümü sade ve detaysızdır, bu yüzden hemen her ortama uyum sağlarlar. Biraz modern – biraz klasik veya daha gösterişli bir görünüm istediğiniz mekanlar için plise perdeyi kumaş perdelerle kombinleyerek de kullanabilirsiniz.



## Plise Perde Nedir?

Katlanır cam balkon sistemleri ve PVC Kapı, pencereler için sıklıkla tercih edilen, ipli mekanizmasıyla aşağı-yukarı yönlü hareket imkanı sağlayan, mekanda gün ışığının yumuşak bir şekilde dağılımını sağlayan bir perde türüdür. Özellikle çatı katları, gemiler, kış bahçeleri, katlanır cam balkon sistemleri gibi mekanların çok köşeli, eğimli, bazen ulaşılması zor olan pencereleri için kullanılmaya uygundur. Görünümü dekoratif, kullanımı pratiktir. Belli bir boyuta kadar tek parça olarak uygulanabildiği gibi ayrı cam kanatlara uygun ebattaki parçalar halinde monte edilerek uygulanabilmektedir.

Modern bir dizaynı olan bu fonksiyonel perde türü tasarım ilkelerinin bir avantajı olarak mekanlarda enerji sarfiyatının azaltılmasına yardımcı olur. Güçlü ve kullanışlı bir perde türüdür. Katlanmış hali çok az yer kapladığı için görüntü kirliliğine yol açmaz. 3 metre uzunluğundaki bir tepe penceresine uygulanması durumunda, toplandığında kapladığı yer 10 cm civarındadır. Farklı renk seçenekleri mevcuttur. Esnek yapısı sayesinde dar bölgelerde, asimetrik formlu, üçgen veya dairesel pencerelerde, tavanlarda kullanılabilir. Pencere kanatlarıyla tavan arasındaki mesafenin az olması durumunda da uygulanabilir. Mekanları sıcak günlerde fazla ısınmaktan korur, istenilen ölçüde mahremiyet sağlar.

Tavan camları veya cam balkon için perdeye ihtiyacınız varsa plise perde sizin için en iyi seçim olacaktır.

## İple Kontrol Etmek Tek Seçenek Değil

Plise perdenizi mekanizmasındaki ip sistemi yardımıyla kontrol edebilir veya motorlu olarak üretilmesini tercih edebilirsiniz.





**T Profil Kapak**  
T Profile Cover

Paket İçi Adet Amount within package	1.000	Koli İçi Adet Amount within parcel	2.000
---	-------	---------------------------------------	-------



**Small T Profil Kapak**  
Small T Profile Cover

Paket İçi Adet Amount within package	1.000	Koli İçi Adet Amount within parcel	2.000
---	-------	---------------------------------------	-------



**Çiftli Orta Profil Kapak**  
Double Middle Profile Cover

Paket İçi Adet Amount within package	500	Koli İçi Adet Amount within parcel	500
---	-----	---------------------------------------	-----



**20'lik T Profil Kapak**  
20 T Profile Cover

Paket İçi Adet Amount within package	1.000	Koli İçi Adet Amount within parcel	2.000
---	-------	---------------------------------------	-------



**Yaylı Yapışkan Profil Kapak**  
Spring Adhesive Profile Cover

Paket İçi Adet Amount within package	1.000	Koli İçi Adet Amount within parcel	2.000
---	-------	---------------------------------------	-------



**Yaylı Portray Profil Kapak**  
Spring Portray Profile Cover

Paket İçi Adet Amount within package	1.000	Koli İçi Adet Amount within parcel	2.000
---	-------	---------------------------------------	-------



**Kilit Takımı (Çıtırçıtı)**  
Lock Set (with snap fastener)

Paket İçi Adet Amount within package	2.000	Koli İçi Adet Amount within parcel	2.000
---	-------	---------------------------------------	-------

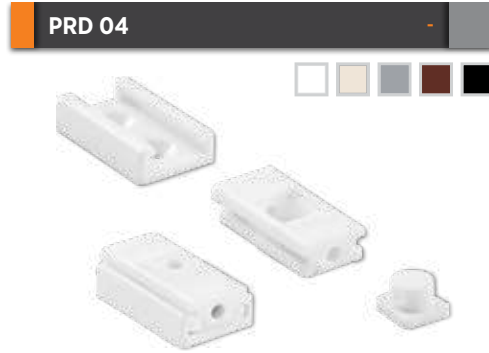

**Kilit Takımı (Alyanlı)**  
Lock Set (with hex key)

Paket İçi Adet Amount within package	2.000	Koli İçi Adet Amount within parcel	2.000
---	-------	---------------------------------------	-------

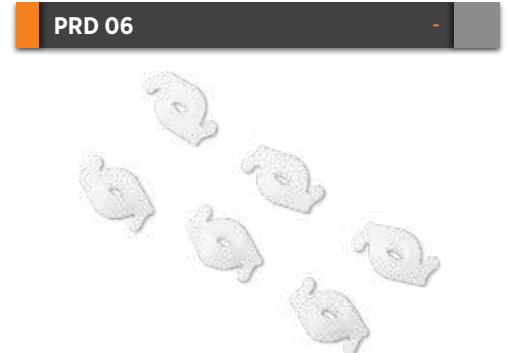

**Çiftli Orta Profil Klips**  
Double Middle Profile Clip

Paket İçi Adet Amount within package	500	Koli İçi Adet Amount within parcel	500
---	-----	---------------------------------------	-----



**Yaylı Portray Klips**  
Spring Portray Cleps

Koli İçi Adet Amount within parcel	500
---------------------------------------	-----



**Kuş Gözü (Metal) 4 mm**      **Kuş Gözü (Metal) 3 mm**  
Rivet (Metal) 4 mm      Rivet (Metal) 3 mm

Koli İçi Adet Amount within parcel	5.000	Koli İçi Adet Amount within parcel	5.000
---------------------------------------	-------	---------------------------------------	-------



**Kuş Gözü (Plastik)**  
Rivet (Plastic)

Paket İçi Adet Amount within package	10.000
---	--------

PRD 47



**Çiftli Orta Profil Klips Anahtarı (Metal)**  
Double Middle Profile Clip Key (Metal)

Paket İçi Adet Amount within package	1	Koli İçi Adet Amount within parcel	1
---	---	---------------------------------------	---

PRD 35



**Perde Çekme Aparatı**  
Curtain Pulling Apparatus

Paket İçi Adet Amount within package	1	Koli İçi Adet Amount within parcel	1
---	---	---------------------------------------	---

PRD 34



**Montaj Vidası (2,9x6,5 YHB)**  
Mounting Screw (2.9x6.5 YHB)

Koli İçi Adet Amount within parcel	10.000
---------------------------------------	--------

PRD 07



**12 mm Bantlı Şerit**  
12 mm Taped Strip

Paket İçi Adet Amount within package	50	Koli İçi Adet Amount within parcel	500
---	----	---------------------------------------	-----

PRD 39



**Çift Taraflı Silikonlu Bant**  
Double Sided Silicone Tape

Paket İçi Adet Amount within package	1	Koli İçi Adet Amount within parcel	35 m
---	---	---------------------------------------	------

PRD 05



**Plise Perde İp**  
Pleat Curtain Rope

Paket İçi Adet Amount within package	1 rulo/ roll	Koli İçi Adet Amount within parcel	12
---	--------------	---------------------------------------	----

PRD 30

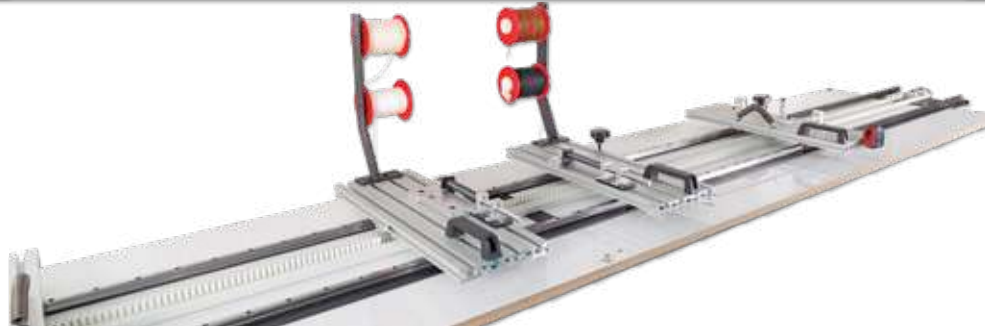

**İp Ayar Boylama Tezgahı**  
Rope Adjustment Lengthening Machine

PRD 31



**Kumaş Delme Makinesi**  
Fabric Punching Machine

PRD 32



**Kumaş Kesim Makinesi**  
Fabric Cutting Machine

PRD 33



**Perçin Makinesi**  
Rivet Machine

# PLİSE PERDE PROFİLLERİ

Pleated Blinds Profiles



312

**T Profil**  
T Profile

Paket İçi Adet Amount within package	10	Gramajı Weight	0,156 kg/m
---	----	-------------------	------------



334

**20'lik T Profil**  
20 T Profile

Paket İçi Adet Amount within package	10	Gramajı Weight	0,265 kg/m
---	----	-------------------	------------



339

**Yaylı Yapışkan Profil**  
Spring Adhesive Profile

Paket İçi Adet Amount within package	10	Gramajı Weight	0,102 kg/m
---	----	-------------------	------------



332

**Small T Profil**  
Small T Profile

Paket İçi Adet Amount within package	10	Gramajı Weight	0,094 kg/m
---	----	-------------------	------------



340

**Yaylı Portray Profil**  
Spring Portray Profile

Paket İçi Adet Amount within package	10	Gramajı Weight	0,076 kg/m
---	----	-------------------	------------



327

**Çiftli Orta Profil**  
Double Middle Profile

Paket İçi Adet Amount within package	10	Gramajı Weight	0,252 kg/m
---	----	-------------------	------------



## Alüminyum Renk Seçeneği

Aluminum Color Options

9016

Beyaz  
White



Eloksal Boyalı  
Anodized Painted



Bronz Boyalı  
Bronze Painted

8003

Altın Meşe  
Golden Oak

8016

Maun  
Mahogany

7016

Antrasit Gri  
Anthracite Gray

## Zip Perde

Zip perde sistemleri, dış mekanları veya büyük cam yüzeyleri rüzgar, güneş ışığı ve böcekler gibi dış etkenlere karşı korumak ve kontrol altına almak için kullanılan özel bir pencere kaplama çözümdür. Zip perdeler, aynı zamanda "screen perdeleri" olarak da adlandırılır ve aşağıdaki özelliklere sahiptir:

## Zip Blinds

Zip blind systems are a specialized window covering solution used to protect and control outdoor spaces or large glass surfaces from external factors such as wind, sunlight, and insects. Zip blinds are also referred to as "screen blinds" and have the following features:

### Fonksiyonellik:

Zip perdeler, güneş ışığına karşı koruma sağlar ve iç mekan sıcaklığını kontrol etmek için kullanılır. Aynı zamanda yağmur, rüzgar ve böcekler gibi dış etkenlere karşı da koruma sunar.

### Functionality:

Zip blinds provide protection against sunlight and are used to control indoor temperatures. They also offer protection against external elements like rain, wind, and insects.

### Estetik Tasarım:

Zip perdeler, modern ve şık bir görünüme sahiptir. Dikey yönde çalışabilen bir sistemle tasarlanırlar ve bu, farklı pencere türlerine uygunluk sağlar.

### Aesthetic Design:

Zip blinds have a modern and stylish appearance and can be designed with a system that operates vertically, making them suitable for various types of windows.

### Güneş Işığı Kontrolü:

Zip perdeler, güneş ışığını isteğe bağlı olarak engelleyebilir veya iç mekana geçirilebilir. Bu, iç mekanın aydınlatmasını ve sıcaklığını ayarlamak için kullanışlıdır.

### Sunlight Control:

Zip blinds can either block or allow sunlight to enter the interior as desired, making it convenient for adjusting indoor lighting and temperature.

### Rüzgar Dayanıklılığı:

Bu perdeler, dayanıklı ve rüzgarlı hava koşullarına karşı dirençli olarak tasarlanır. Rüzgarla temas ettiğinde dengeli ve sabit kalırlar.

### Wind Resistance:

These blinds are designed to withstand strong and windy weather conditions, remaining stable even when in contact with the wind.

### Kullanım Kolaylığı:

Otomatik kontrol seçenekleri mevcuttur. Otomasyon, kullanım kolaylığı sağlar ve perdelerin istenen pozisyonda sabit kalmasını sağlar.

### Ease of Use:

Zip blinds come with automatic options, providing convenience and allowing the blinds to stay in the desired position.

### Sineklik İşlevi:

Zip perdeler, açık havada oturma alanları veya teraslar için idealdir. Aynı zamanda sineklik işlevi görebilir ve böceklerin içeri girmesini engelleyebilir.

### Insect Protection:

Zip blinds are ideal for outdoor seating areas or terraces, as they can also function as insect screens, preventing bugs from entering.

### Uzun Ömür:

Kaliteli malzemelerle yapıldığında, zip perdeler uzun yıllar boyunca dayanıklılık ve performans sunabilirler.

### Longevity:

When made from high-quality materials, zip blinds can offer durability and long-lasting performance.



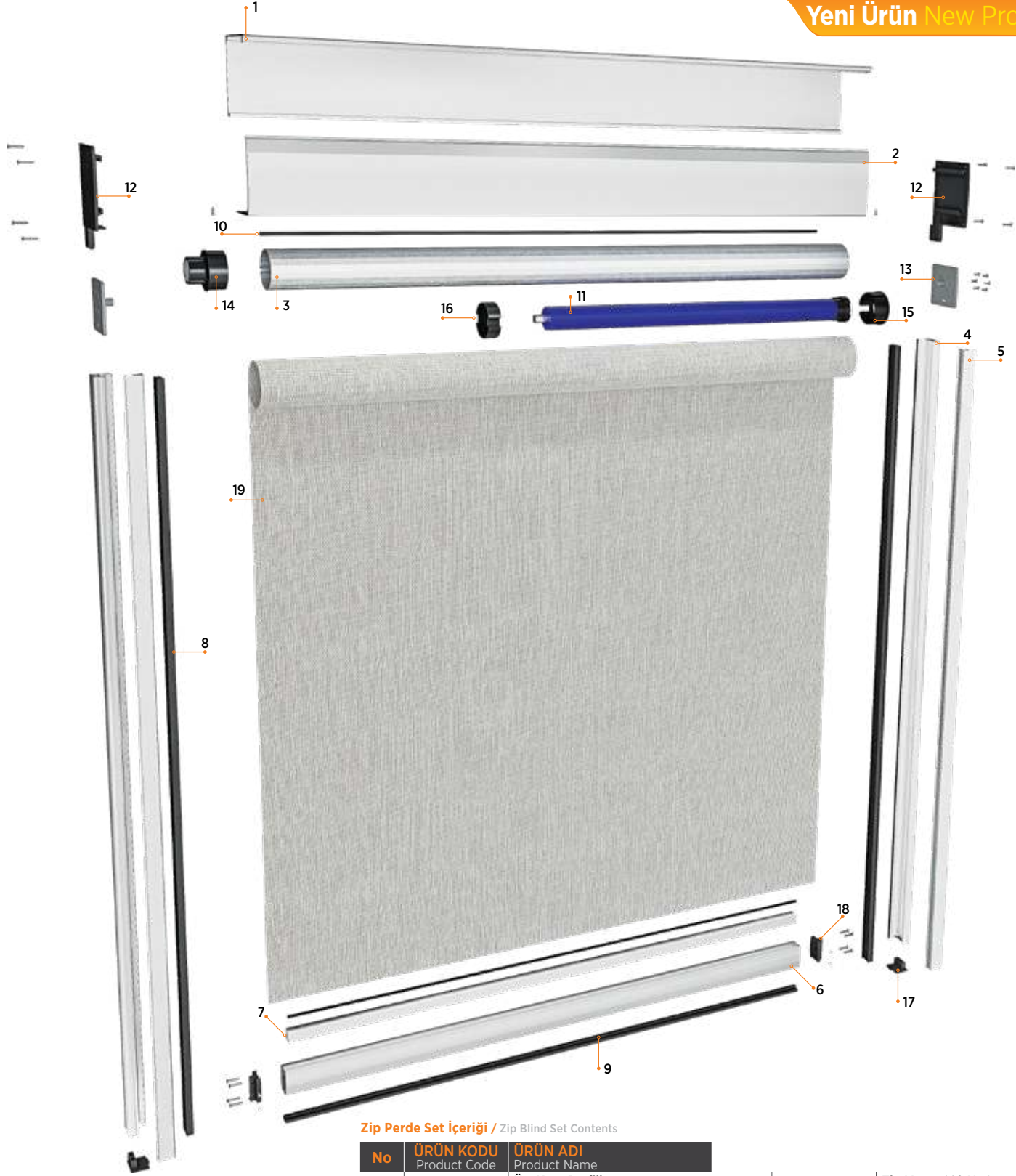

Zip Perde Set İçeriği / Zip Blind Set Contents

No	ÜRÜN KODU Product Code	ÜRÜN ADI Product Name
1	7150	Üst Kasa Profili Upper Case Profile
2	7151	Üst Kasa Kapak Profili Upper Case Cover Profile
3	ZP 13	Sac Tambur Borusu Sheet Drum Tube
4	251	Yan Kasa Profili Side Case Profile
5	252	Yan Kasa Kapak Profili Side Case Cover Profile
6	250	Kanat Profili Wing Profile
7	ZP 15	5x20 Lama Demir 5x20 Blade Iron
8	ZP 09	Fermuar Aparatı Zipper Apparatus
9	ZP 10	Kanat Contası Wing Seal
10	ZP 11	Perde Plastiği Curtain Plastic

11	ZP 12	Zip Motor (40 Nm) Zip Engine 40 Nm
12	ZP 01	Üst Kasa Kapak - Sağ/Sol Upper Case Cover - Right/Left
13	ZP 02	Çelik Pimli Motor Bağlantı Parçası Steel Pinned Motor Connection Part
14	ZP 03	Rulmanlı Tambur Bağlantı Bearing Drum Connection
15	ZP 04	Motorlu Tambur Bağlantı Motorized Drum Connection
16	ZP 05	Rotor Aktarma Parçası Rotor Transmission Part
17	ZP 06	Yan Kasa Kapakları - Sağ/Sol Side Case Covers - Right/Left
18	ZP 07	Kanat Kapakları Wing Covers
19	-	Zip Perde Zip Blind

Zip perdeler, özellikle evler, restoranlar, kafeler, oteller ve ticari binalar gibi birçok farklı mekan için popüler bir seçenektir. Bu perdeler, iç mekan konforunu artırmak ve enerji tasarrufu sağlamak için kullanışlıdır.

Zip blinds are a popular choice for various settings, including homes, restaurants, cafes, hotels, and commercial buildings. They are useful for enhancing indoor comfort and promoting energy efficiency.

# ALÜMİNYUM PROFİL GRUBU

Aluminium Profile Group

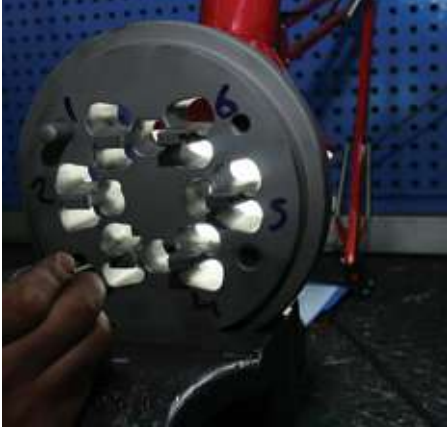

ISO 9001 | ISO 14001 | OHSAS 18001

## GOLD SERİ PLİSE SİNEKLİK / GOLD SERIES PLAİT FLY SCREEN

304

0,318 kg/m

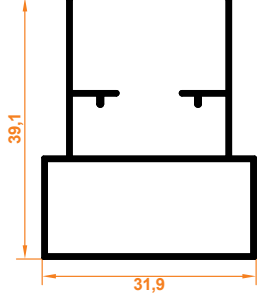

Gold Kasa Profil  
Gold Case Profile

305

0,330 kg/m

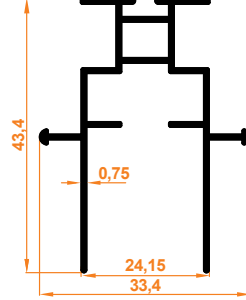

Gold Kanat Profil  
Gold Wing Profile

## STAR SERİ PLİSE SİNEKLİK / STAR SERIES PLAİT FLY SCREEN

302

0,272 kg/m

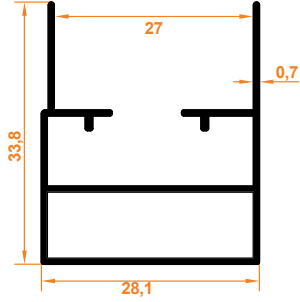

Star Kasa Profil  
Star Case Profile

301

0,303 kg/m

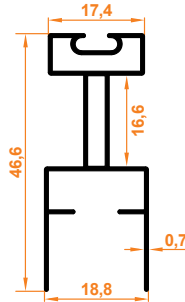

Star Kanat Profil  
Star Wing Profile

## JUNIOR SERİ PLİSE SİNEKLİK / JUNIOR SERIES PLAİT FLY SCREEN

306

0,243 kg/m

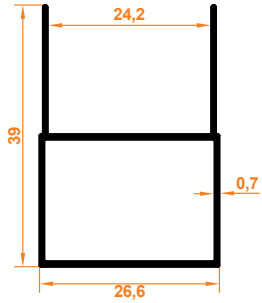

Junior Kasa Profil  
Junior Case Profile

307

0,304 kg/m

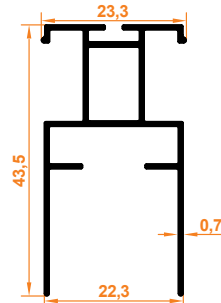

Junior Kanat Profil  
Junior Wing Profile

**SLIM SERİ PLİSE SİNEKLİK / SLIM SERIES PLAİT FLY SCREEN**

**300**

**0,218 kg/m**

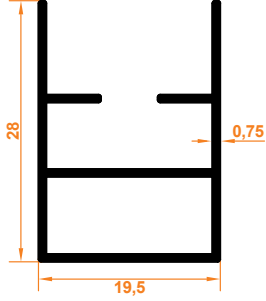

**Slim Kasa Profil**  
Slim Case Profile

**301**

**0,303 kg/m**

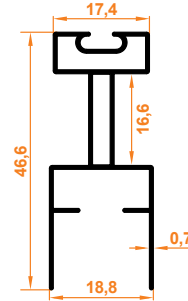

**Slim Kanat Profil**  
Slim Wing Profile

**331**

**0,168 kg/m**



**Slim Eşiksiz Profil**  
Slim Profile without Threshold

**NOBEL SERİ PLİSE SİNEKLİK / NOBEL SERIES PLAİT FLY SCREEN**

**335**

**0,345 kg/m**

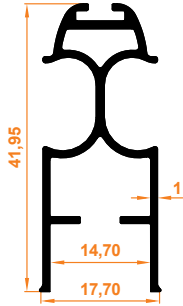

**Nobel Kanat Profili**  
Nobel Wing Profile

**336**

**0,148 kg/m**

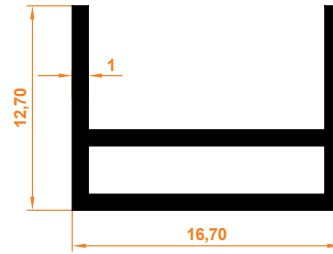

**Nobel Eşiksiz Kasa Profili**  
Nobel Case Profile without Threshold

**338**

**0,250 kg/m**

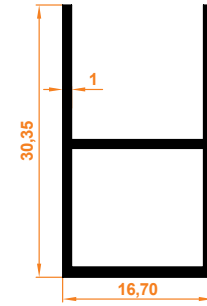

**Nobel Kasa Profili**  
Nobel Case Profile

**SÜPER SERİ PLİSE SİNEKLİK / SUPER SERIES PLAİT FLY SCREEN**

**316**

**0,248 kg/m**

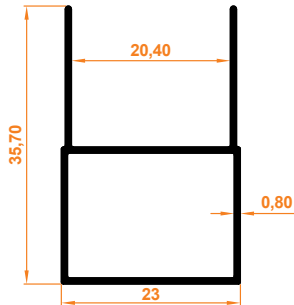

**Süper Seri Profili**  
Super Case Profile

**320**

**0,303 kg/m**

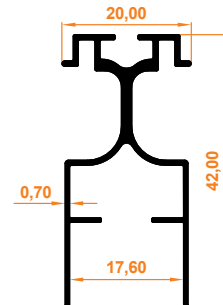

**Süper Seri Kanat Profili**  
Super Wing Profile



## NOBEL SERİ İÇTEN MONTAJLI PLİSE SİNEKLİK / NOBEL SERIES INTERNAL MOUNTED PLAIT FLY SCREEN

337

0,338 kg/m

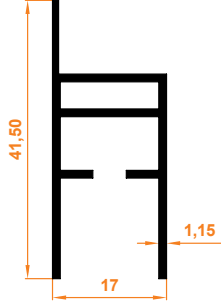

Nobel İçten Montajlı Kasa Profili  
Nobel Internal Mounted Case Profile

335

0,345 kg/m

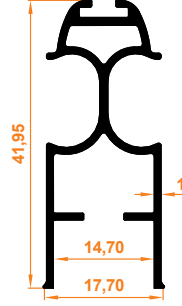

Nobel Kanat Profili  
Nobel Wing Profile

## SLIM SERİ İÇTEN MONTAJLI PLİSE SİNEKLİK / SLIM SERIES INTERNAL MOUNTED PLAIT FLY SCREEN

317

0,272 kg/m

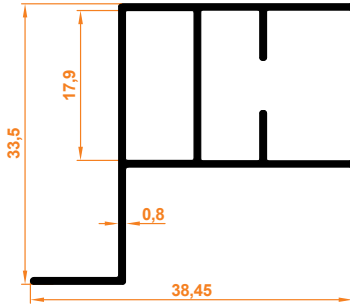

Kasa Profil  
Case Profile

301

0,303 kg/m

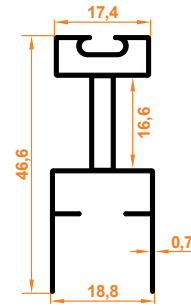

Kanat Profil  
Wing Profile

## İÇTEN MONTAJLI SABİT SİNEKLİK / INTERNAL MOUNTED FIXED FLY SCREEN

405

0,256 kg/m

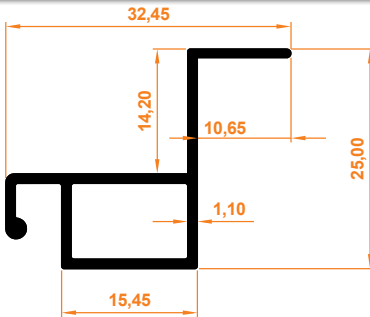

Kasa Profili  
Case Profile

**AYKİM SERİ SİNEKLİK / AYKİM SERIES FLY SCREEN**

309

0,374 kg/m

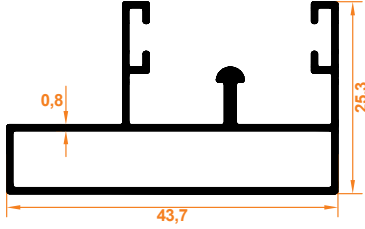

**Aykim Kasa Profil**  
Aykim Case Profile

310

0,315 kg/m

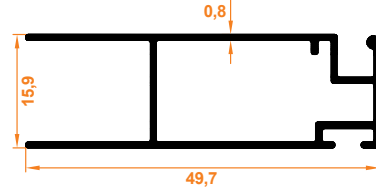

**Aykim Hareketli Profil**  
Aykim Sliding Profile

**PLATİN SERİ SİNEKLİK / PLATİN SERIES FLY SCREEN**

321

0,352 kg/m

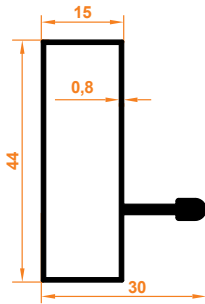

**Platin Tekli Kasa Profil**  
Platin Single Case Profile

322

0,455 kg/m

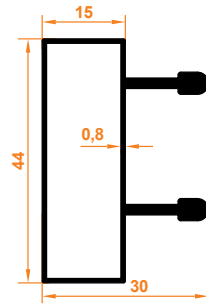

**Platin Çiftli Kasa Profil**  
Platin Double Case Profile

323

0,506 kg/m

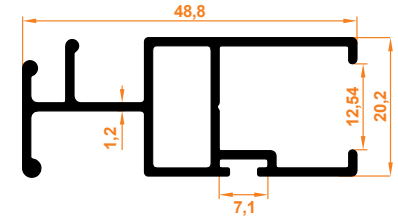

**Platin Kanat Profil**  
Platin Wing Profile

**DÜZ SİNEKLİK PROFİL GRUBU**  
Flat Fly Screen Profile Group

400

0,105 kg/m

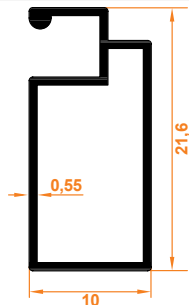

**10x20 Sineklik**  
10x20 Fly Screen

401

0,142 kg/m

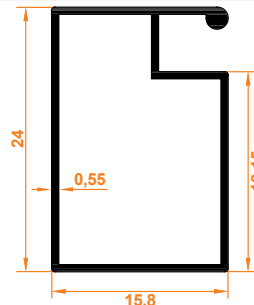

**17x25 Sineklik**  
17x25 Fly Screen

402

0,250 kg/m

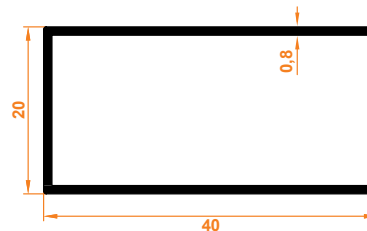

**20x40 Sineklik**  
20x40 Fly Screen

311

0,304 kg/m

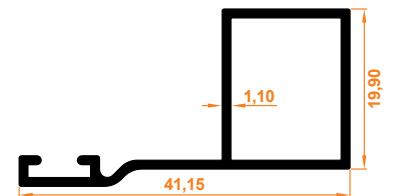

**İçe Açılır Fitilli Sineklik Profili**  
Inward Foldable Flyscreen Profile

# STOR SİNEKLİK PROFİL GRUBU

Stor Fly Screen Profile Group

407

0,342 kg/m

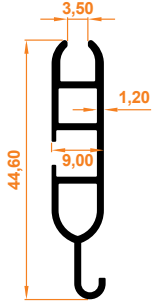

Stor Kanat Profil  
Stor Wing Profile

408

0,286 kg/m

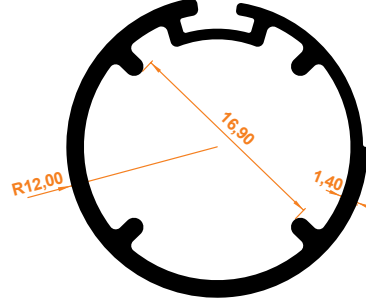

Stor Boru Profil  
Stor Pipe Profile

409

0,526 kg/m

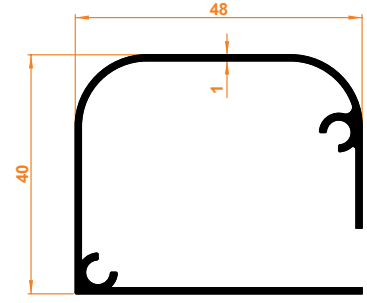

Stor Kasa Profil  
Stor Case Profile

410

0,413 kg/m

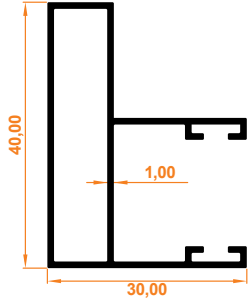

Stor Yan Kasa Profil  
Stor Side Case Profile

411

0,318 kg/m

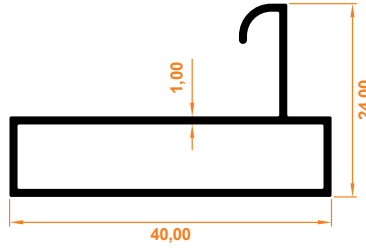

Stor Alt Kasa Profil  
Stor Bottom Case Profile

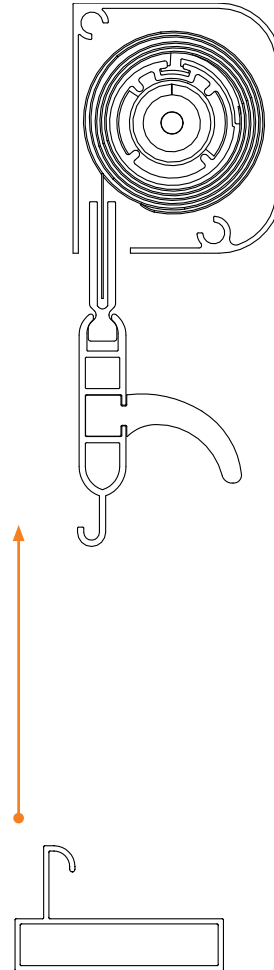
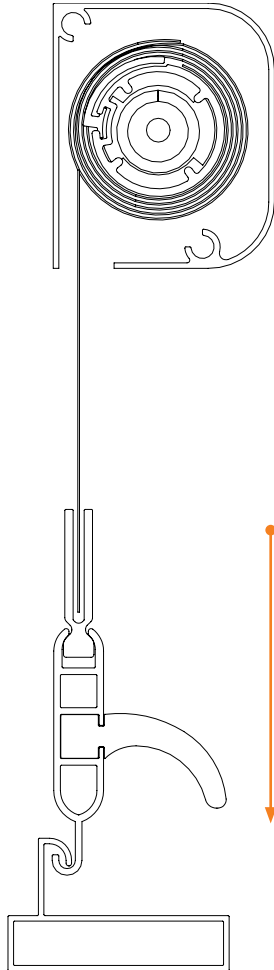

1

0,247 kg/m

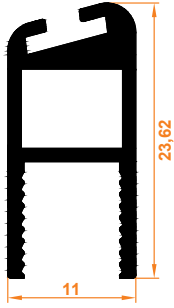

**Büyük D Fitol**  
Big D Wick

2

0,167 kg/m

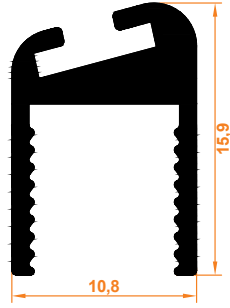

**Küçük D Fitol**  
Small D Wick

3

0,116 kg/m

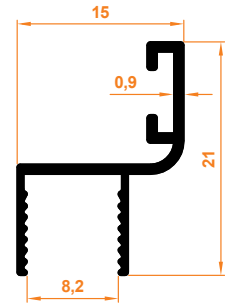

**Küçük h Fitol**  
Small h Wick

4

0,150 kg/m

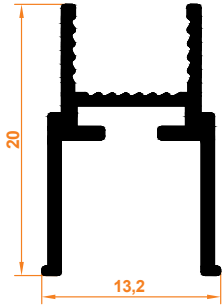

**Orta H Fitol**  
Middle H Wick

5

0,214 kg/m

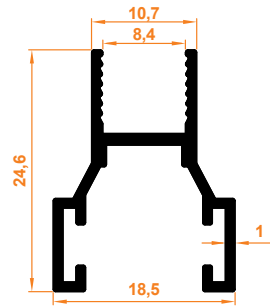

**Büyük H Fitol**  
Big H Wick

6

0,276 kg/m

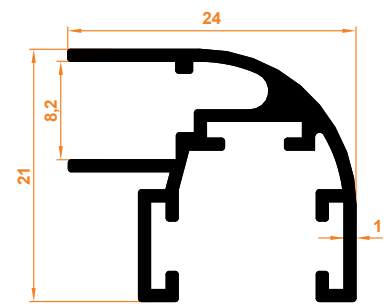

**Köşe Dönüş Fitol**  
Corner Return Wick

# 8 mm CAM BALKON PROFİL GRUBU

8 mm Glass Balcony Profile Group

101

0,078 kg/m

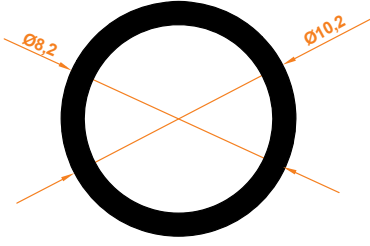

10'lu Stoplama  
10 Stopping Profile

104

0,717 kg/m

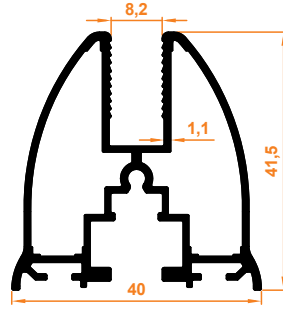

Gold Baza  
Gold Base

105

0,730 kg/m

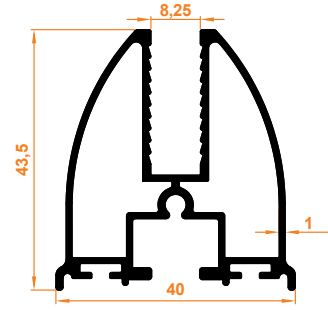

Firtina Baza  
Firtina Base

109

1,355 kg/m

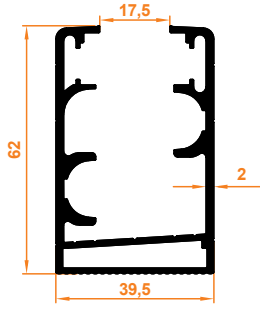

Düz Kasa Profil  
Flat Case Profile

110

1,396 kg/m

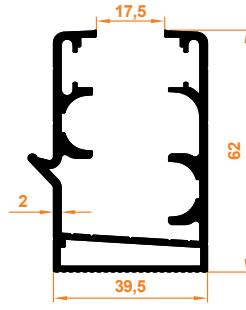

Oluklu Kasa Profil  
Corrugated Case Profile

100

0,441 kg/m

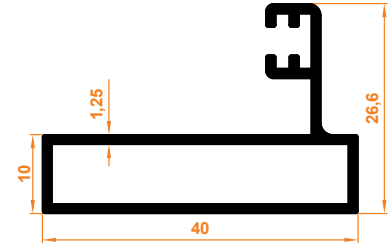

Dar Yan Dikme  
Thin Side Column

106

1,611 kg/m

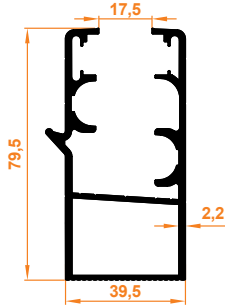

Oluklu Büyük Kasa Profil  
Corrugated Big Case Profile

107

1,570 kg/m

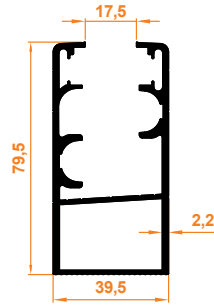

Büyük Düz Kasa Profil  
Big Flat Case Profile

108

0,457 kg/m

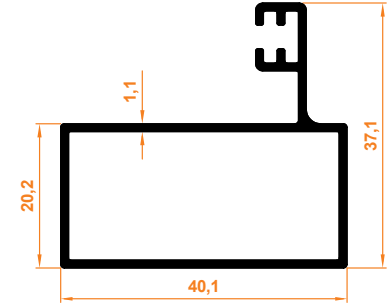

Geniş Yan Dikme  
Thick Side Column Profile

111

1,062 kg/m

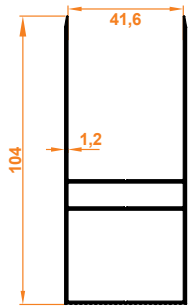

Stor Profil  
Stor Profile

135

0,517 kg/m

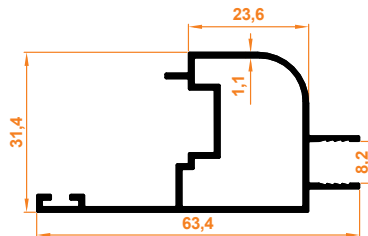

8 mm İspanyolet Profil  
8 mm Espagnolette Profile

136

0,343 kg/m

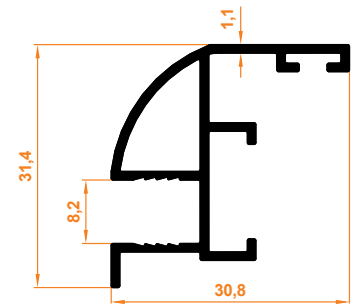

8 mm İspanyolet Profil Karşılığı  
8 mm Espagnolette Combination Profile

800

0,618 kg/m

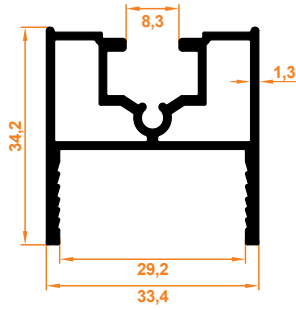

**Baza Profil**  
Base Profile

801

0,321 kg/m

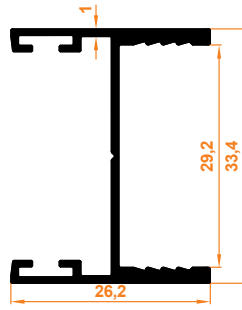

**Düz Kapak Profil**  
Flat Cover Profile

802

0,327 kg/m

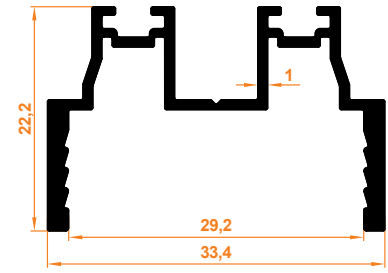

**Düz Kapak Menteşe Profil**  
Flat Cover with Hinge Profile

803

0,445 kg/m

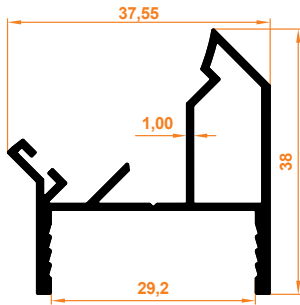

**45° Dönüş Profil**  
45° Return Profile

804

0,378 kg/m

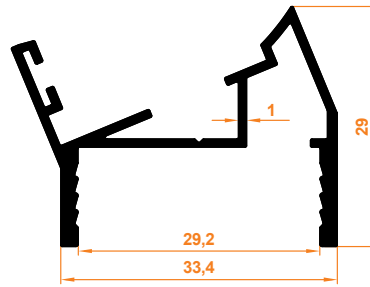

**22,5° Dönüş Profil**  
22,5° Return Profile

805

0,366 kg/m

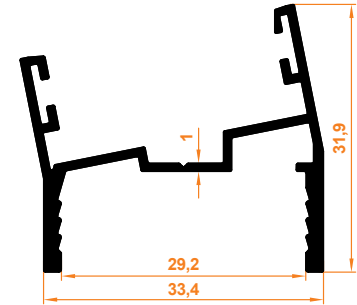

**11° Dönüş Profil**  
11° Return Profile

806

0,475 kg/m

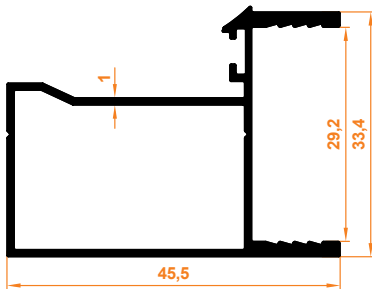

**90° Dönüş Profil**  
90° Return Profile

807

0,346 kg/m

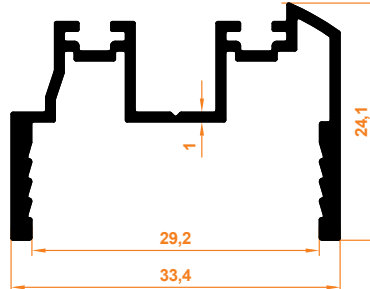

**Açılı Dönüş Menteşe Profil**  
PopUp Return Hinge Profile

808

0,369 kg/m

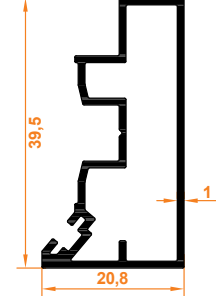

**Yan Dikme Profil**  
Side Column Profile

809

0,328 kg/m

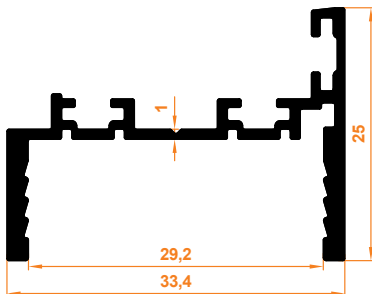

**Sabit Cam Menteşe Profil**  
Stable Glass Hinge Profile

810

0,355 kg/m

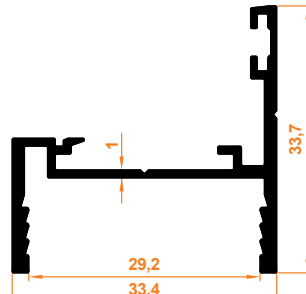

**Sabit Cam Kilit Profil**  
Stable Glass Lock Profile

811

0,342 kg/m

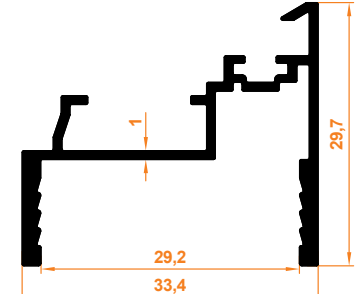

**Sabit Cam Kilit Karşılığı Profil**  
Stable Glass Lock Prevention Profile

819

1,344 kg/m

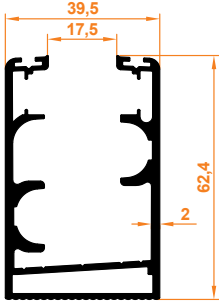

**Düz Kasa Üstten Fitilli Profil**  
Flat Case Top Wicked Profile

820

1,389 kg/m

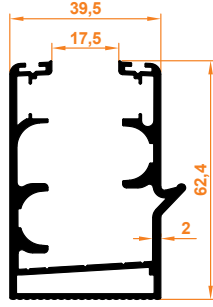

**Oluklu Kasa Üstten Fitilli Profil**  
Corrugated Case Top Wicked Profile

822

0,378 kg/m

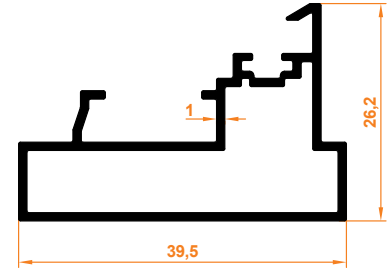

**Açılır Dikme Profil**  
PopUp Column Profile

816

1,577 kg/m

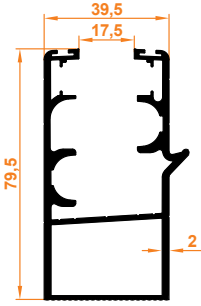

**Üstten Fitilli Büyük Oluklu Kasa**  
Large Corrugated Case with Top Wick

817

1,532 kg/m

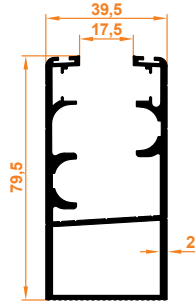

**Üstten Fitilli Büyük Düz Kasa**  
Large Flat Case with Wed from Top

815

0,100 kg/m

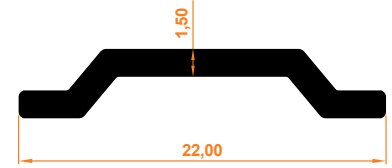

**Tij Profil**  
Espagnolette Profile

823

0,459 kg/m

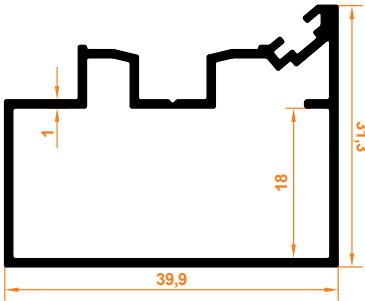

**Geniş Yan Dikme**  
Wide Side Column

824

0,583 kg/m

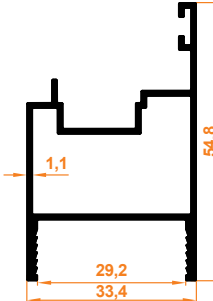

**Sabit Cam İspanyolet Profil**  
Fixed Glass Espagnolette Profile

825

0,356 kg/m

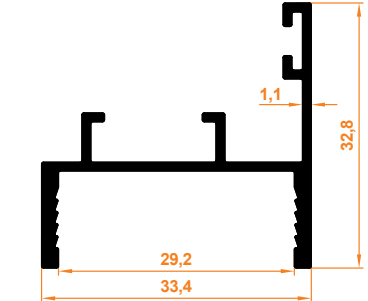

**Sabit Cam İspanyolet Karşılık Profil**  
Fixed Glass Espagnolette Handle Provision Profile

210

0,643 kg/m

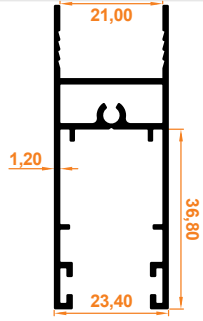

**Sürme Baza Profil**  
Sliding Base Profile

215

0,908 kg/m

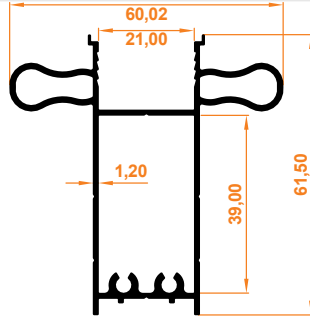

**Cekme Kol Profil**  
Pull Handle Profile

212

0,423 kg/m

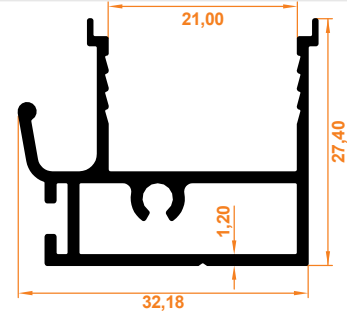

**Kenet Profil**  
Clamp Profile

211

0,301 kg/m

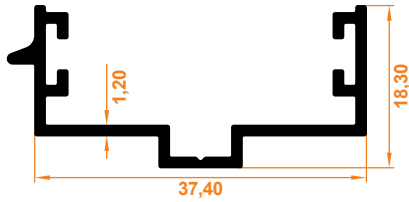

**Birleştirme Karşılık Profil**  
Combination Provisions Profile

213

0,974 kg/m

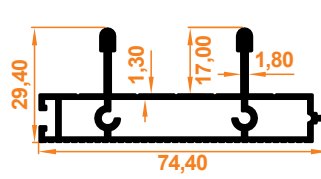

**İkili Eşikli Alt Kasa Profil**  
Double Threshold Lower Case Profile

222

1,333 kg/m

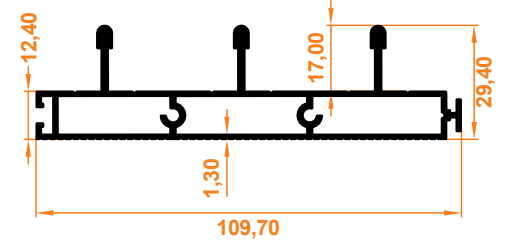

**Üçlü Eşikli Alt Kasa Profil**  
Triple Threshold Lower Case Profile

220

0,867 kg/m

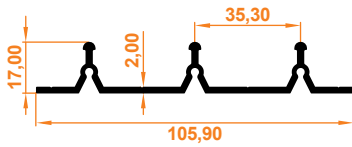

**Üçlü Eşiksiz Alt Kasa Profil**  
Triple Bottom Case Profile without Threshold

221

1,156 kg/m

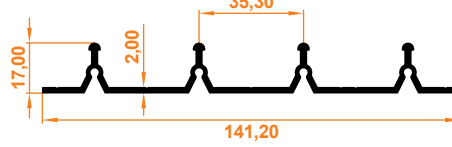

**Dörtlü Eşiksiz Alt Kasa Profil**  
Quadruple Bottom Case Profile without Threshold

219

0,219 kg/m

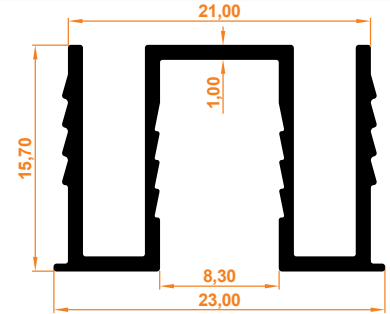

**8 mm Cam Adaptörü**  
8mm Glass Adapter

214

0,587 kg/m

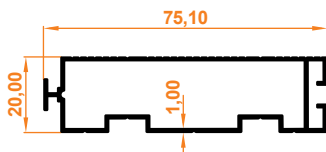

**İkili Yan Kasa Profil**  
Double Side Case Profile

223

0,792 kg/m

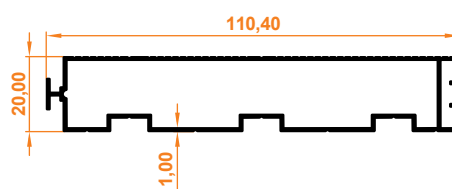

**Üçlü Yan Kasa Profil**  
Triple Side Case Profile

226

0,071 kg/m

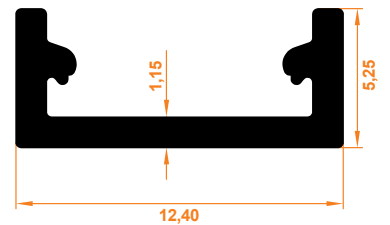

**Kapatma Profil**  
Closing Profile



227

0,957 kg/m

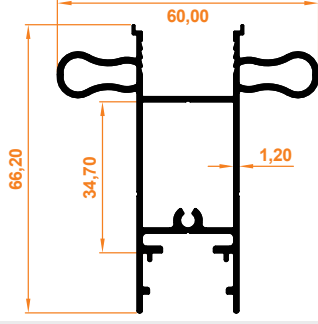

İspanyolet Çekme Kol Profili  
Espagnolette Pull Handle Profile

228

0,156 kg/m

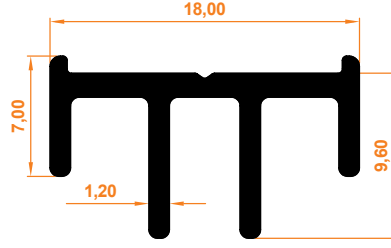

İspanyolet Karşılık Profili  
Espagnolette Provision Profile

229

1,120 kg/m

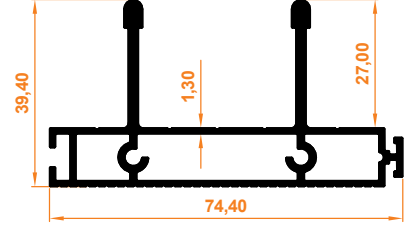

İkili Üst Kasa Profili  
Double Upper Case Profile

230

1,552 kg/m

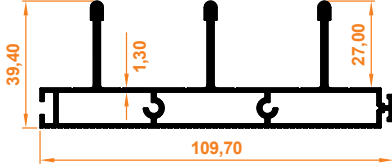

İkili Üçlü Kasa Profili  
Triple Upper Case Profile

## Sürme Sistem Çalışma Mekanizması

Sliding System Operating Mechanism

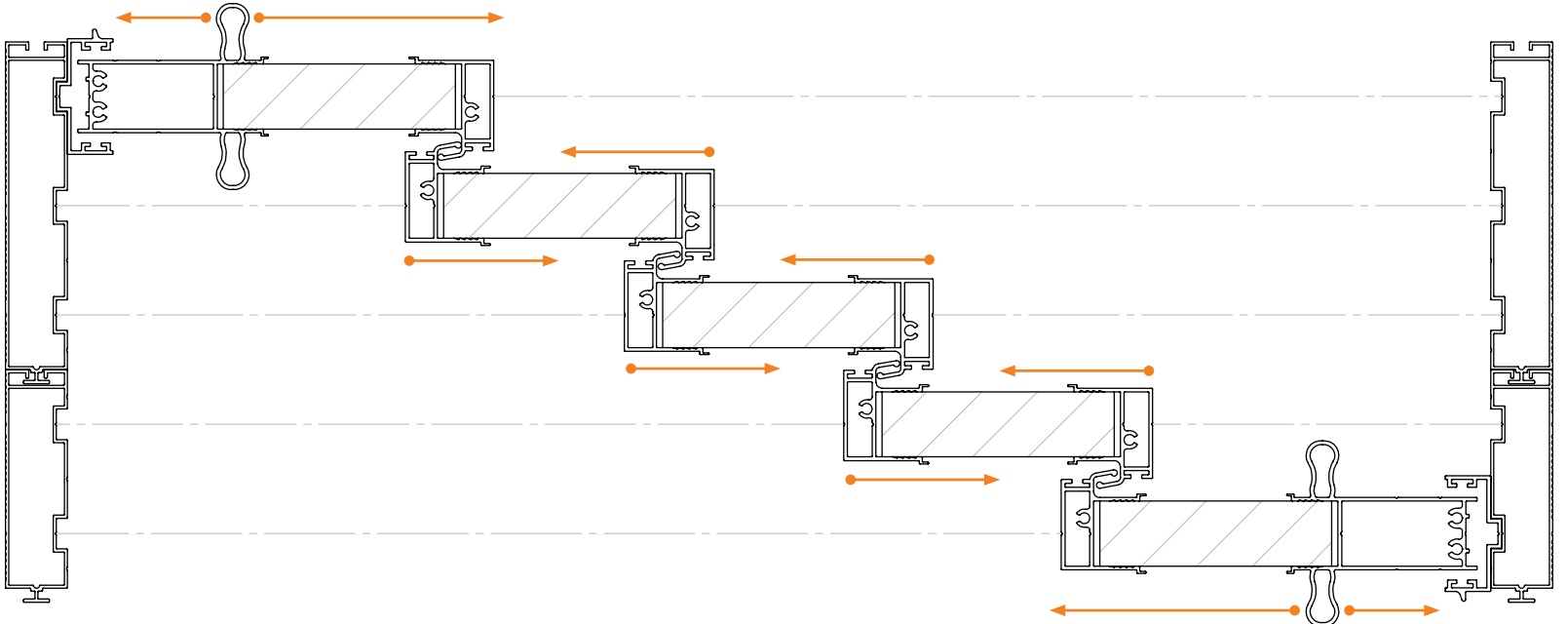

**Sürme Sistem Çalışma Mekanizması**

Sliding System Operating Mechanism

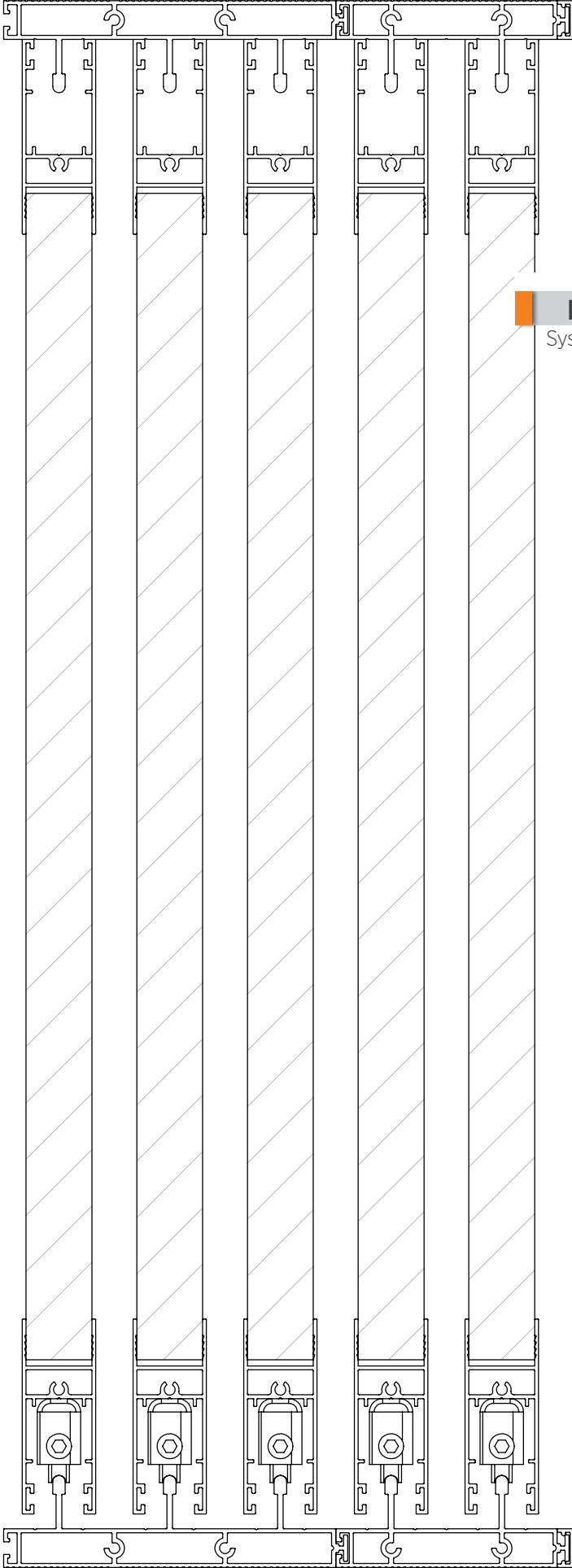

**Eşikli Sistem**

System with Treshold

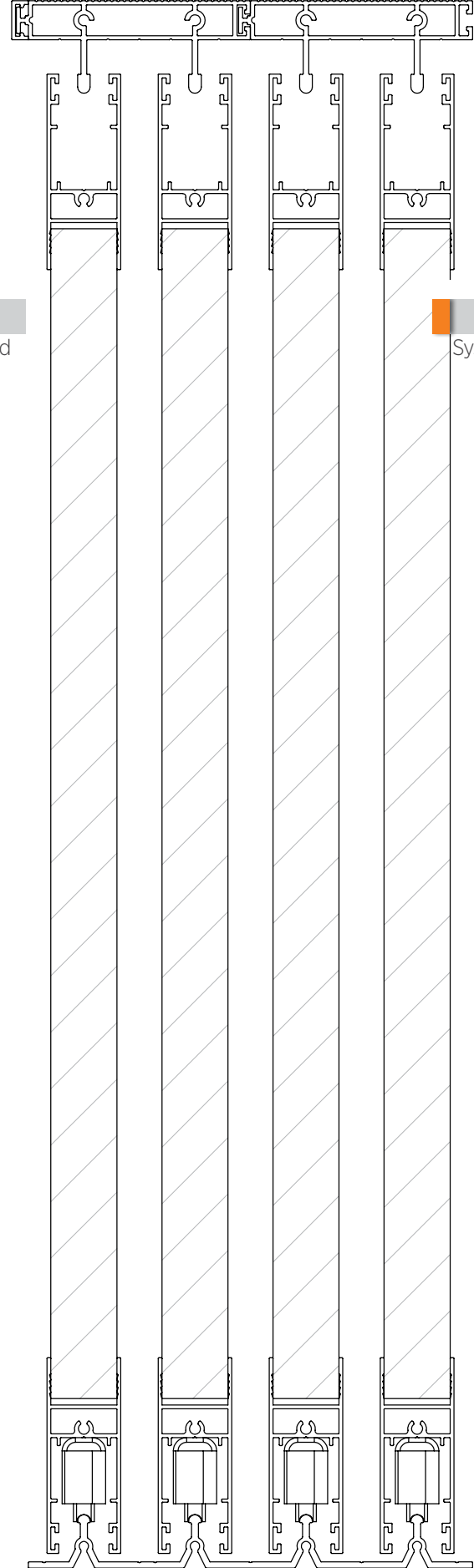

**Eşiksiz Sistem**

System without Treshold

140

0,563 kg/m

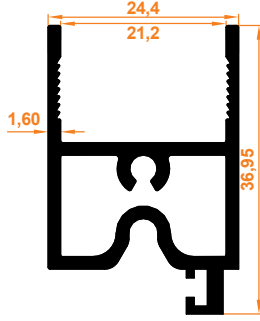

Sabit Panel Açılır Alt Baza Profil  
Fixed Panel Pop-up Base Profile

164

0,842 kg/m

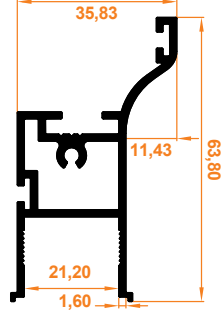

Sabit Panel Yan Dikme Profil  
Fixed Panel Side Column Profile

142

0,750 kg/m

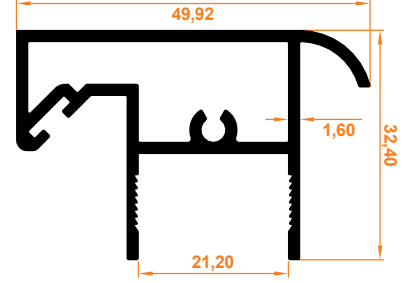

Sabit Panel Üst Baza Profil  
Fixed Panel Top Base Profile

167

1,144 kg/m

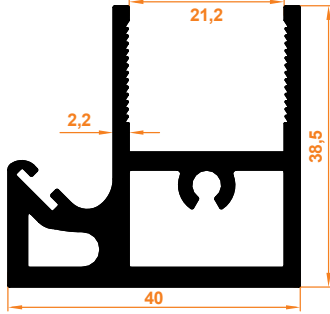

Kenet Baza Profil  
Clamp Base Profile

144

0,434 kg/m

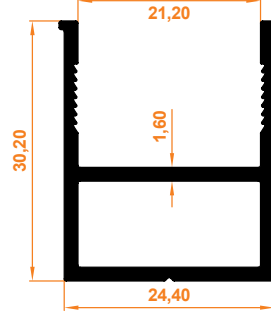

Hareketli Panel Yan Dikme Profil  
Movable Panel Side Column Profile

145

0,579 kg/m

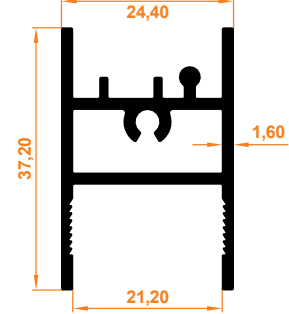

Küpeşte Baza Profil  
Handrail Base Profile

146

0,741 kg/m

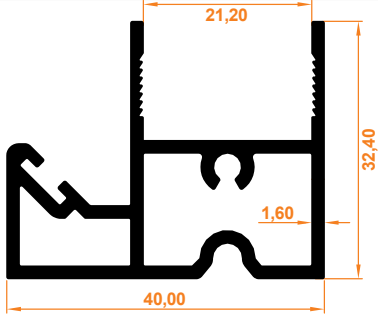

Hareketli Panel Açılır Alt Baza Profil  
Movable Panel Pop-up Lower Base Profile

161

0,482 kg/m

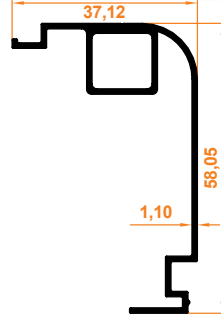

Ray Kapatma "T" Profil  
Rail Closure "T" Profile

160

1,057 kg/m

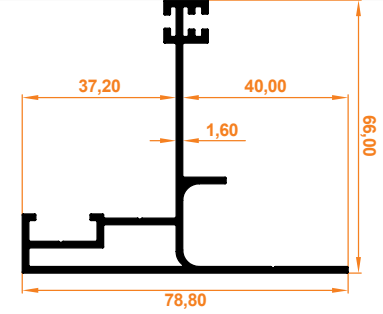

Yan Ray "T" Profil  
Side Rail "T" Profile

166

0,144 kg/m

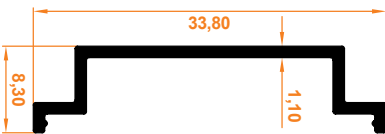

Açılımlı için Ray Kapatma 'L' Profil  
Rail Closure 'L' Profile for Opening

162

0,703 kg/m

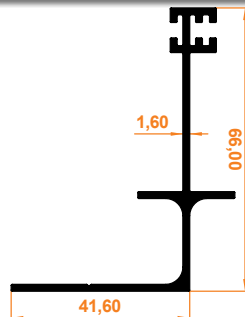

Yan Ray "L" Profil  
Side Rail "L" Profile

GYT 28

2,110 kg/m

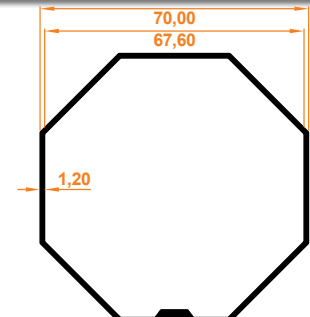

Sac Tambur Borusu  
Sheet Drum Pipe

152

1,563 kg/m

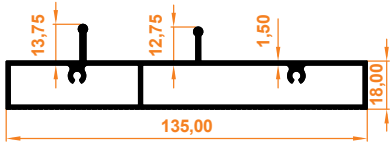

**Alt Kasa**  
Guillotine Lower Case Profile

156

3,449 kg/m

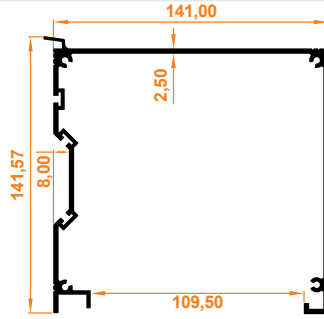

**Üst Kasa Profil**  
Top Case Profile

153

0,864 kg/m



**Üst Kasa Kapak Profil**  
Top Case Cover Profile

155

1,669 kg/m

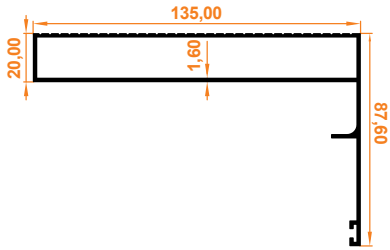

**Yan Kasa Profil**  
Side Case Profile

154

0,759 kg/m

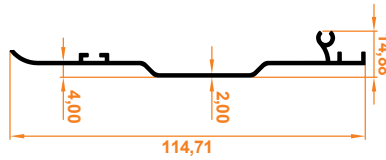

**Küpeşte Profil**  
Handrail Profile

165

0,644 kg/m



**Yan Kasa Kertme Profil**  
Side Case Notched Profile

158

0,510 kg/m

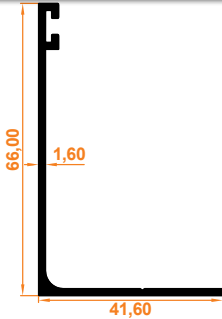

**Açılımsız Tek Fıtil Yan Ray L Kasa Profil**  
Single Weatherstrips Without Opening Side L Case Profile

159

0,660 kg/m

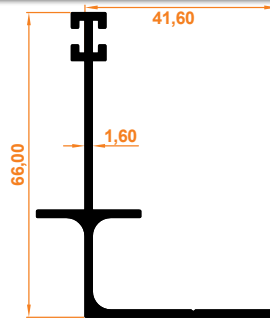

**Açılımsız Çift Fıtil Yan Ray L Kasa Profil**  
Double Weatherstrips Without Opening Side L Case Profil

219

0,219 kg/m

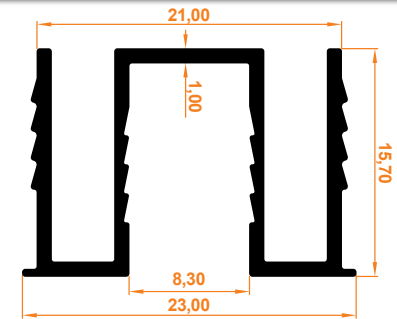

**8 mm Cam Adaptörü**  
8mm Glass Adapter

149

0,162 kg/m

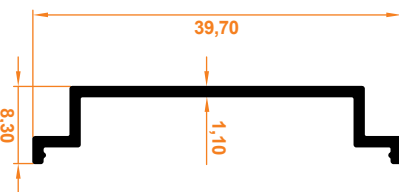

**Açılımsız için Ray Kapatma 'L' Profil**  
Rail Closure 'L' Profile for Non-Opening

## Giyyotin Sistem Çalışma Mekanizması

Guillotine System Operating Mechanism

1. Kademe - Level 1

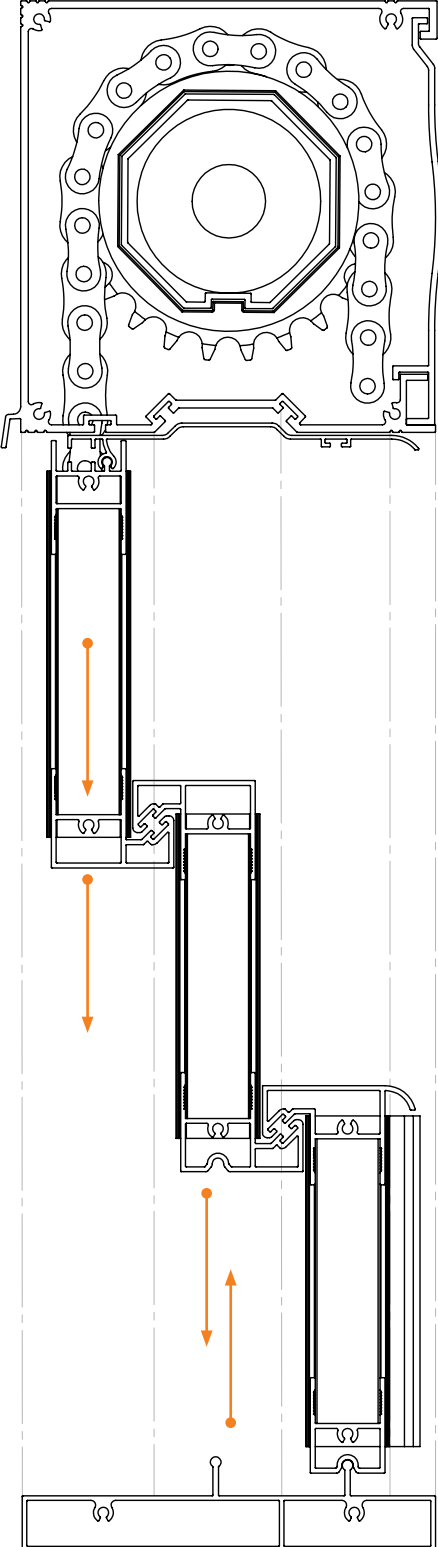

2. Kademe - Level 2

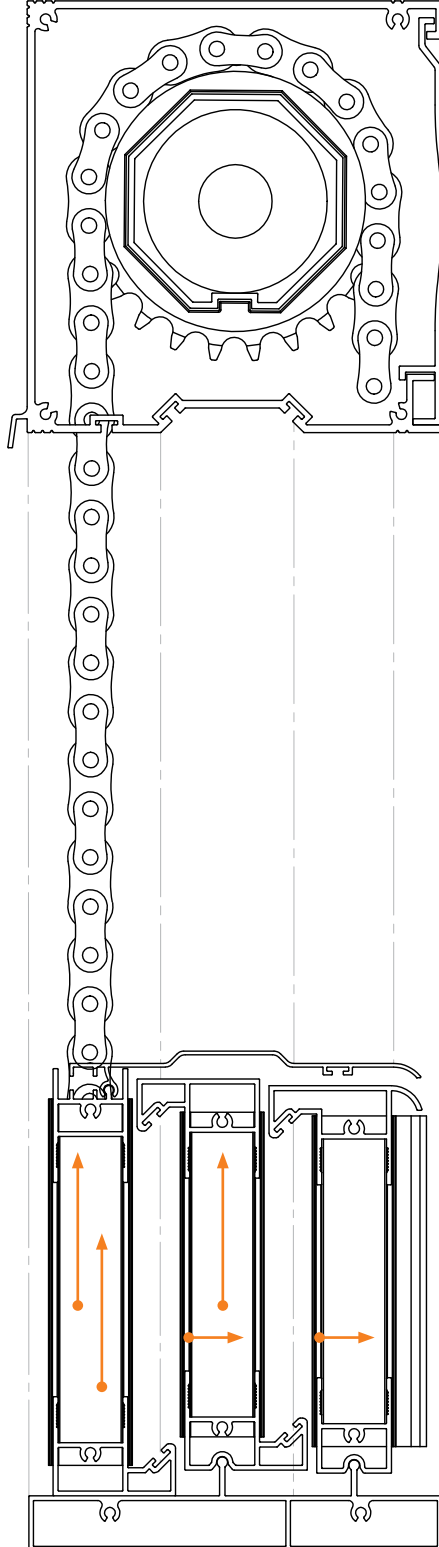

3. Kademe - Level 3

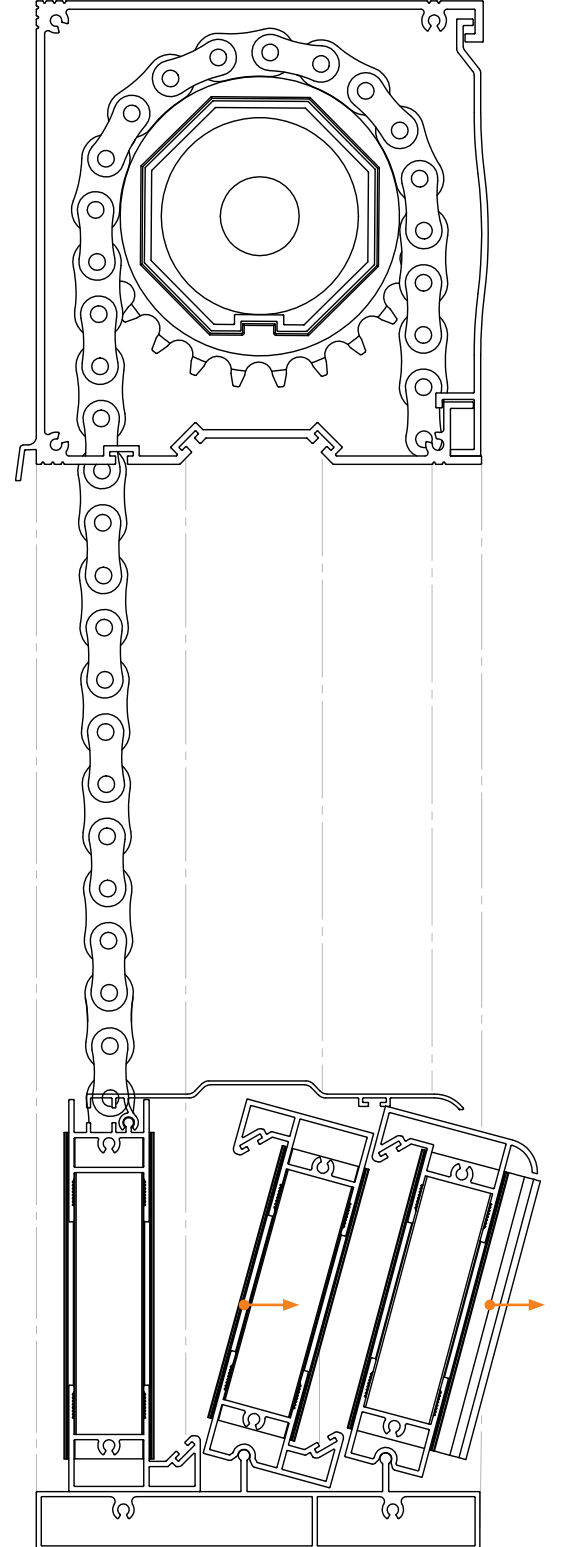

417

0,467 kg/m

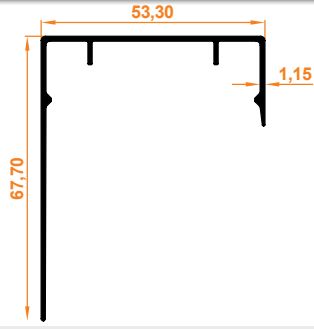

**Sonlandırıcı Cam Çita Kapak Profili**  
End Cap Glass Strip Cover Profile

418

0,329 kg/m

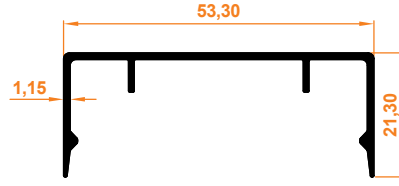

**Cam Çita Kapak Profili**  
Glass Strip Cover Profile

419

2,100 kg/m

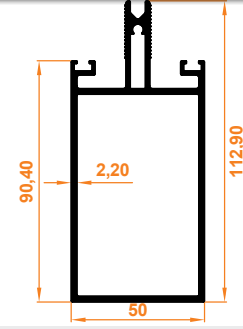

**Orta Kayıt Profili**  
Center Mullion Profile

420

0,682 kg/m

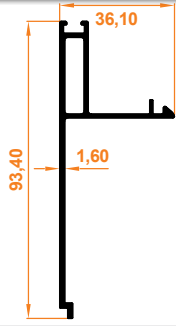

**Kasa Kapatma Profili**  
Frame Closure Profile

421

3,184 kg/m

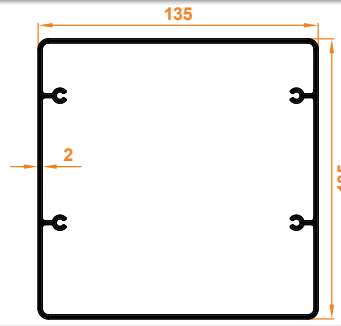

**Ayak Profili**  
Leg Profile

422

4,318 kg/m

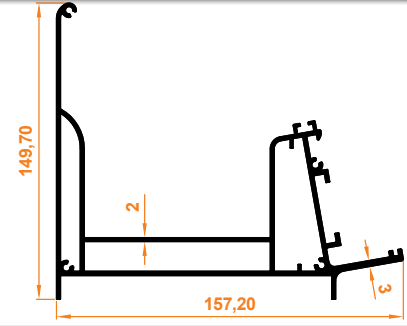

**Oluk Profili**  
Groove Profile

423

3,142 kg/m

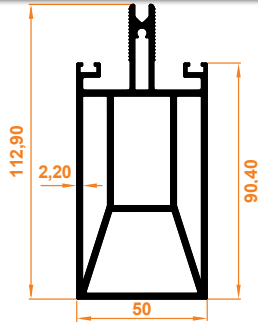

**Destekli Orta Kayıt Profili**  
Reinforced Center Mullion Profile

424

2,835 kg/m

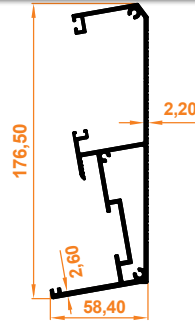

**Duvar Kasa Profili**  
Wall Frame Profile

425

0,847 kg/m

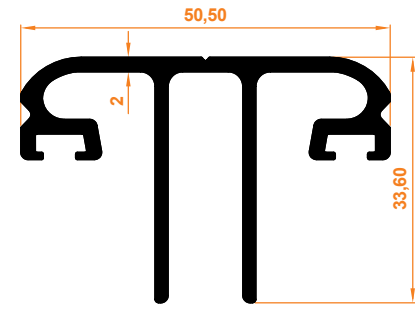

**Cam Çita Profili**  
Glass Strip Profile

# C60 SERİ ALÜMİNYUM PROFİL GRUBU

C60 Series Aluminum Profile Group

7100

0,921 kg/m

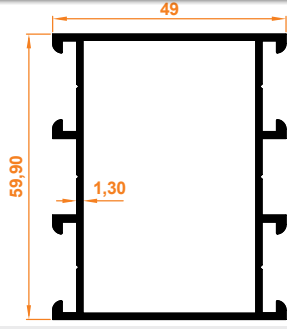

C60 Kasa / Orta Kayıt Profili  
Chassis / Mid Entry Profile

7101

0,988 kg/m

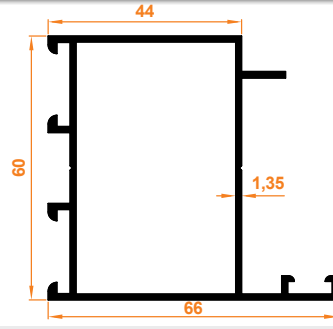

C60 Kanat Profili  
C60 Airfoil

7102

1,440 kg/m

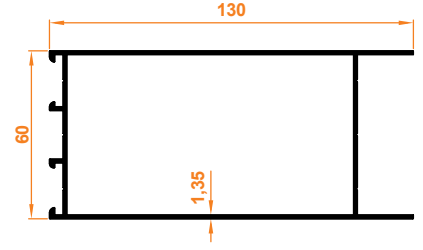

C60 Etek Profili  
C60 Skirt Profile

7103

1,099 kg/m

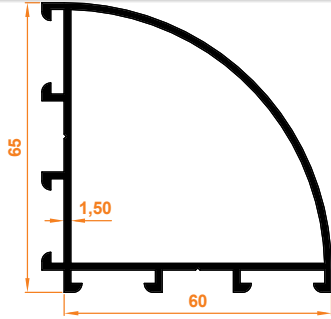

C60 Oval Köşe Dönüş Profili  
C60 Oval Corner Profile

7104

0,436 kg/m

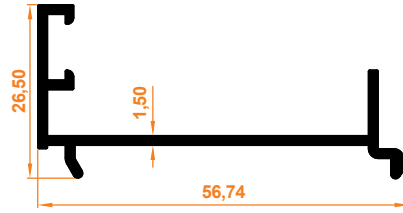

C60 Kanat Adaptörü Profili  
C60 Wing Adapter Profile

7105

1,155 kg/m

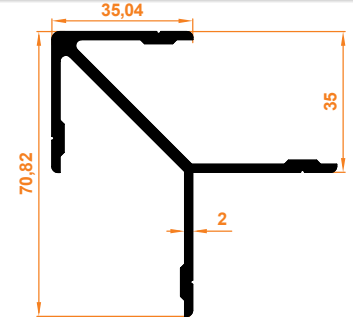

C60 Köşe Takozu  
C60 Corner Wedge

7106

0,467 kg/m

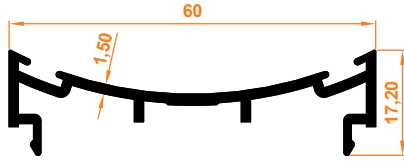

C60 Çarpma Kapı Adaptörü - D  
C60 Crash Door Adapter - F

7107

0,367 kg/m

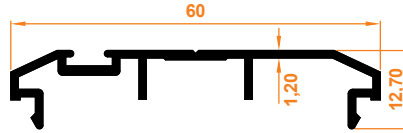

C60 Çarpma Kapı Adaptörü - E  
C60 Crash Door Adapter - M

7108

0,241 kg/m

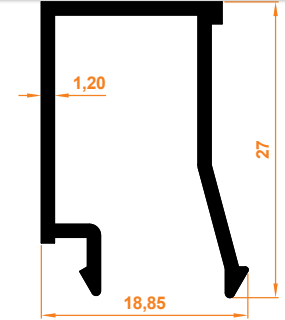

C60 Isıcam Çıta Profili  
C60 Insulating Glass Stave Profile

7109

0,234 kg/m

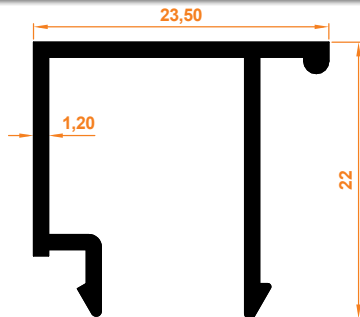

C60 Tek Cam Çıta Profili  
C60 Single Glass Stave Profile

7000

0,473 kg/m

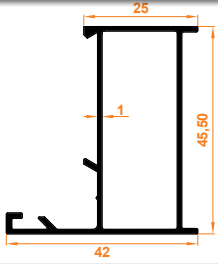

**Aldoks (Dar) Kasa Profili**  
Aldoks (Narrow) Frame Profile

7001

0,565 kg/m

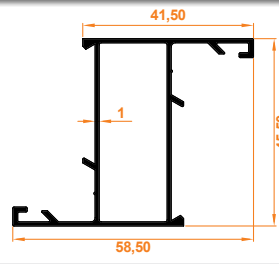

**Aldoks (Dar) Kanat Profili**  
Aldoks (Narrow) Airfoil

7002

0,565 kg/m

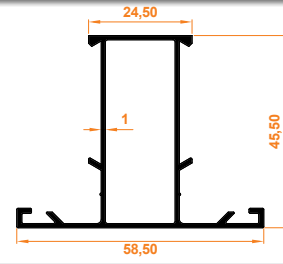

**Aldoks (Dar) Orta Kayıt Profili**  
Aldoks (Narrow) Medium Entry Profile

7003

0,891 kg/m

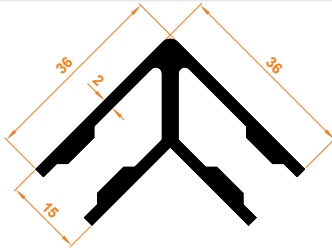

**Aldoks (Dar) Köşe Takozu**  
Aldoks (Narrow) Corner Wedge

7004

0,565 kg/m

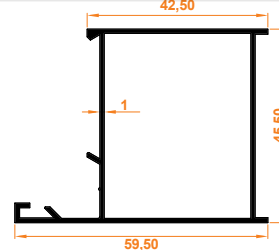

**Aldoks (Orta) Kasa Profili**  
Aldoks (Medium) Frame Profile

7005

0,659 kg/m

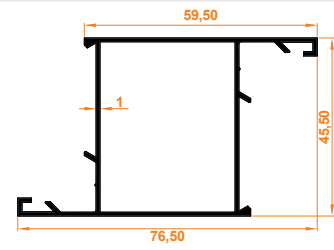

**Aldoks (Orta) Kanat Profili**  
Aldoks (Medium) Airfoil

7006

0,659 kg/m

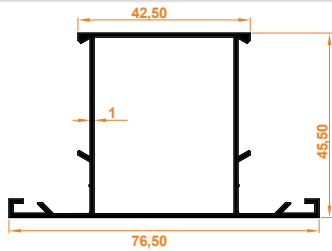

**Aldoks (Orta) Orta Kayıt Profili**  
Aldoks (Medium) Medium Entry Profile

7007

1,136 kg/m

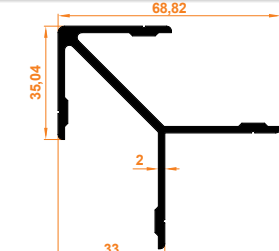

**Aldoks (Orta) Köşe Takozu**  
Aldoks (Medium) Corner Wedge

7008

0,695 kg/m

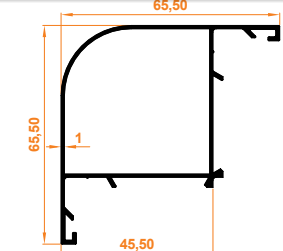

**Aldoks Oval Köşe Dönüş Profili**  
Aldoks Oval Corner Profile

7009

0,719 kg/m

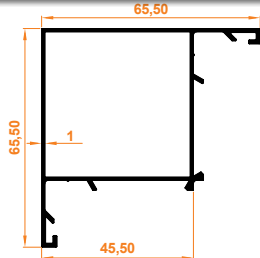

**Aldoks Köşe Dönüş Profili**  
Aldoks Corner Profile

7010

1,028 kg/m

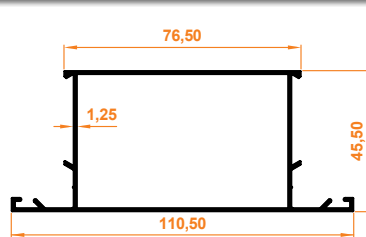

**Aldoks (Geniş) Orta Kayıt Profili**  
Aldoks (Wide) Medium Entry Profile

7011

1,028 kg/m

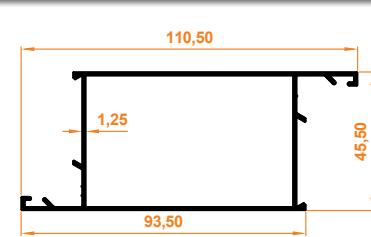

**Aldoks (Geniş) Kanat Profili**  
Aldoks (Wide) Airfoil

7012

1,149 kg/m

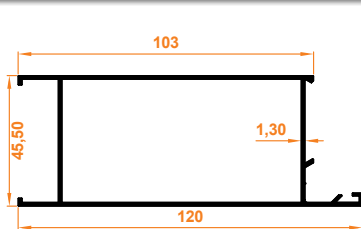

**Aldoks Etek Profili**  
Aldoks Skirt Profile

7013

0,215 kg/m

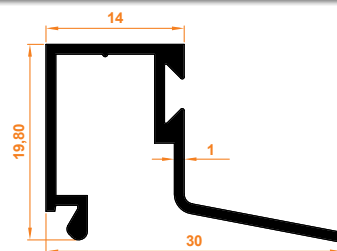

**Aldoks Isıcam Çita**  
Aldoks Double Glazing Stave

7014

0,213 kg/m

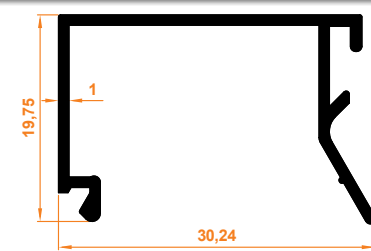

**Aldoks Tek Cam Çita**  
Aldoks Single Glass Stave



700

0,185 kg/m

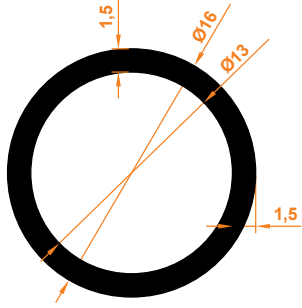

16x1,5 Boru  
16x1,5 Pipe

701

0,538 kg/m

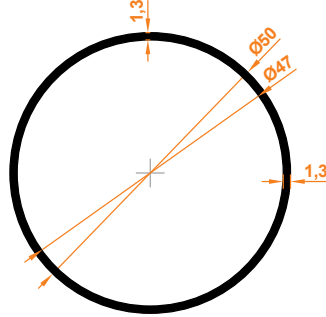

50x1,3 Boru  
50x1,3 Pipe

702

0,509 kg/m

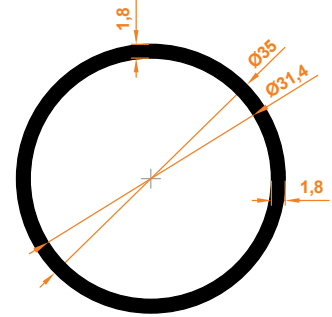

35x1,8 Boru  
35x1,8 Pipe

703

0,182 kg/m

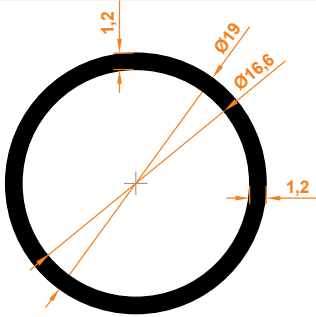

19x1,2 Boru  
19x1,2 Pipe

704

0,162 kg/m

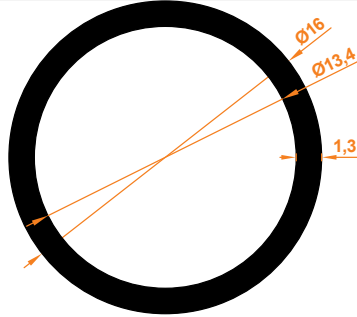

16x1,3 Boru  
16x1,3 Pipe

900

0,685 kg/m

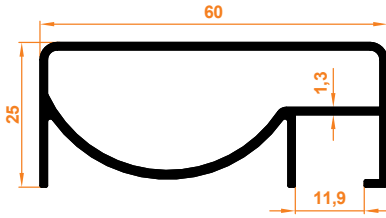

60x25 mm Üst Küpeşte Yandan Kanallı  
60x25 mm Upper Handrail with Side Channel

901

0,230 kg/m

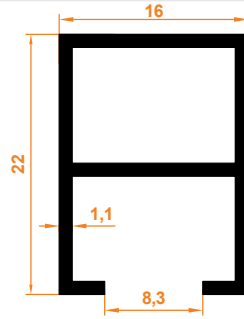

Cam Tutucu  
Glass Holder

902

0,848 kg/m

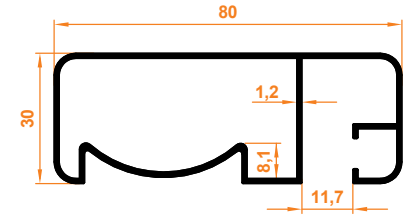

80x30 Yandan Kanallı  
80x30 Side Slot

903

0,785 kg/m

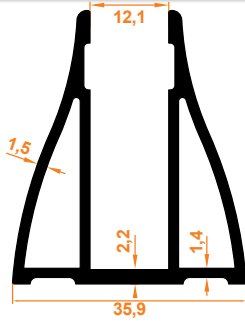

Cam Alt Baza  
Glass Bottom Base

904

0,159 kg/m

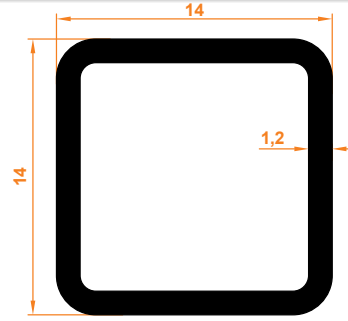

14x14 Emniyet Şeridi  
14x14 Safety Strip

905

0,060 kg/m

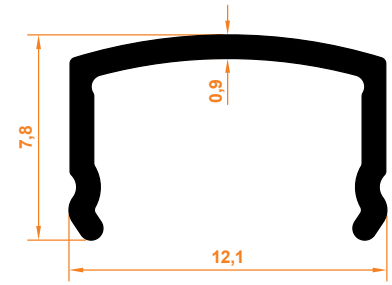

Boru Çıtası  
Pipe Lath

906

0,650 kg/m

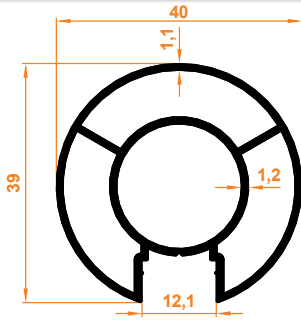

40x1,1 mm Tek Kanallı Çiftli Dikme  
40x1,1 mm Single Slot Double Column

907

0,532 kg/m

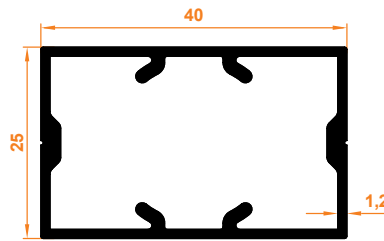

40x25 Dikme  
40x25 Column

908

0,922 kg/m

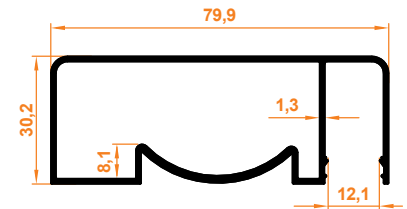

80x30 Yandan Kanallı  
80x30 Side Slot

909

0,717 kg/m

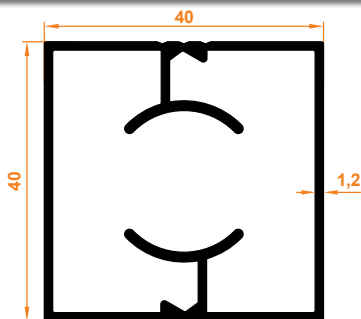

40x40 Kanalsız Dikme  
40x40 Non Slot Column

910

0,631 kg/m

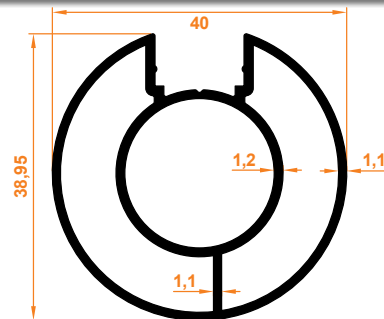

40x1,1 mm Tek Kanallı Tekli Dikme  
40x1,1 mm Single Slot Single Column

911

0,840 kg/m

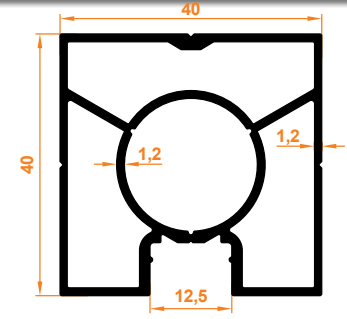

40x40 Tek Kanallı Dikme  
40x40 Single Slot Column

912

0,641 kg/m

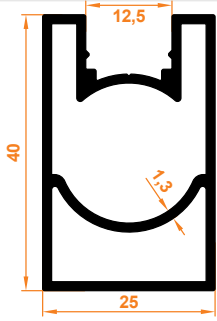

40x25 Tek Kanallı  
40x25 Single Slot

913

0,064 kg/m

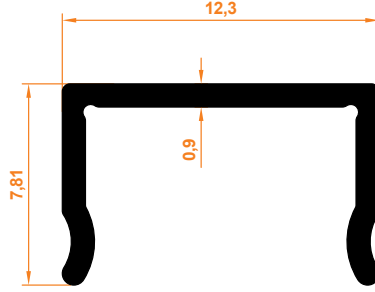

Kare Çita  
Square Slat

914

0,082 kg/m

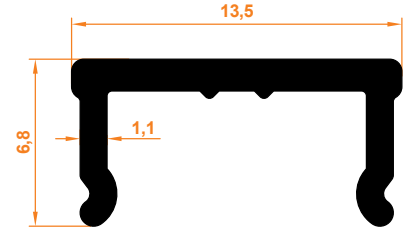

80x30 Yandan Kanallı Çıtası  
80x30 Side Slot Rail

915

0,778 kg/m

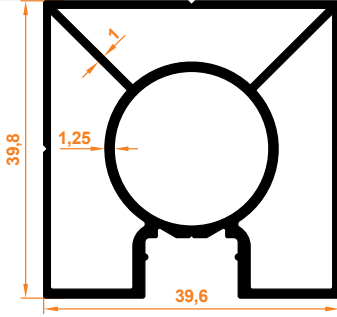

40x40 Tek Kanallı Dikme  
40x40 Single Slot Column

916

0,627 kg/m

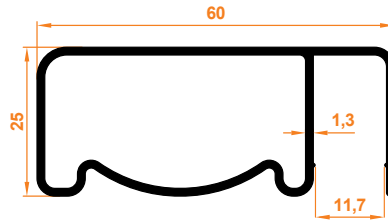

60x25 Yandan Kanallı  
60x25 Side Slot

918

0,256 kg/m

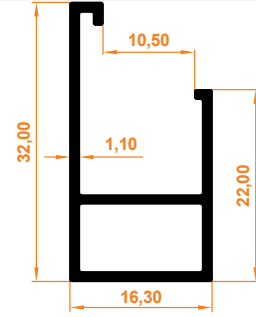

8-10 mm Cam Altı Profil  
8-10 mm Glass Bottom

919

0,807 kg/m

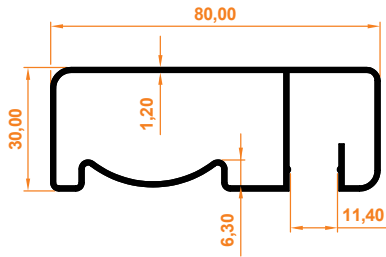

80x30 Yandan Kanallı  
80x30 Side Slot

204

0,347 kg/m

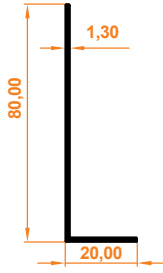

20x80 Köşebent  
20x80 Angle Bracket

205

0,488 kg/m

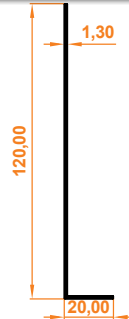

20x120 Köşebent  
20x120 Angle Bracket

510

1,174 kg/m

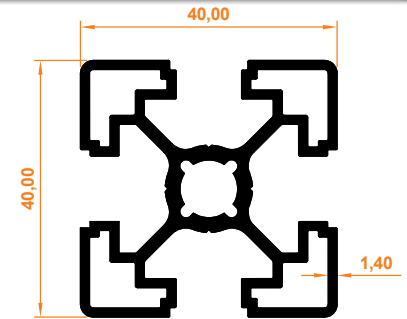

40x40 Sigma Profil  
40x40 Sigma Profile

1003

0,053 kg/m

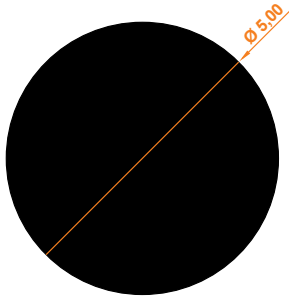

Q5 Dolu Mil  
Q5 Solid Bar

404

0,384 kg/m

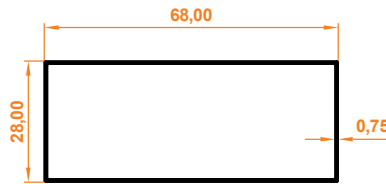

28x68 Kutu Profil  
28x68 Box Profile

1044

0,960 kg/m

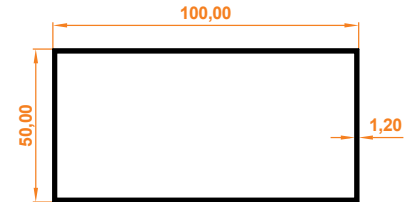

50x100x1,2 mm Kutu Profil  
50x100x1,2 mm Box Profile

1102

0,531 kg/m

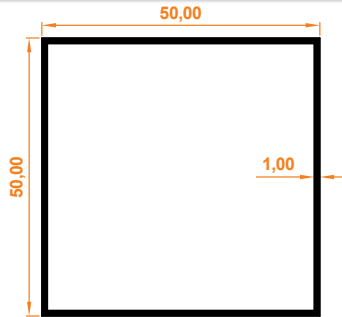

50x50 Kutu Profil  
50x50 Box Profile

1400

0,426 kg/m

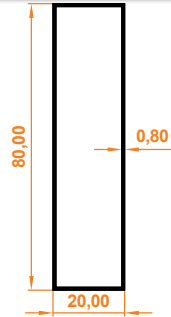

20x80 Kutu Profil  
20x80 Box Profile

1402

0,917 kg/m

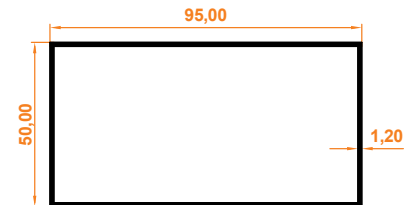

95x50 Kutu Profil  
95x50 Box Profile

1403

0,505 kg/m

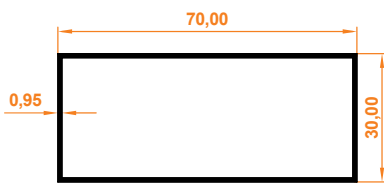

30x70 Kutu Profil  
30x70 Box Profile

7180

0,576 kg/m



40x80 Kutu Profil  
40x80 Box Profile

7

0,305 kg/m

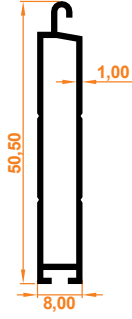

39x55 Alt Parça  
39x55 Lower Part

8

0,502 kg/m

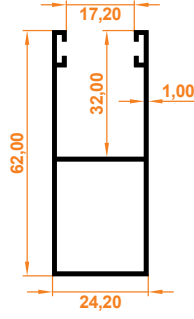

55'lik Yan Dikme  
55 Side Column

9

0,439 kg/m

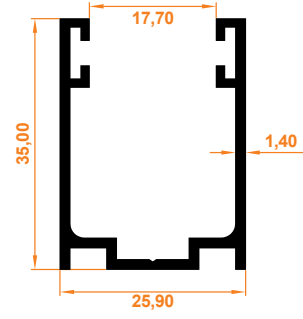

55'lik Kutusuz Dikme  
55 Side Column Boxless

1130

0,372 kg/m

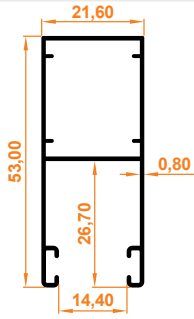

39'luk Yan Dikme  
39 Side Column

250

1,291 kg/m

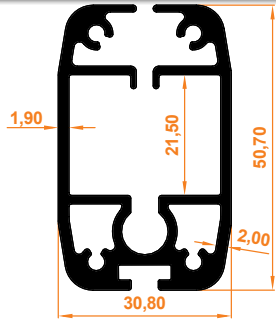

**Kanat Profili**  
Wing Profile

251

0,572 kg/m

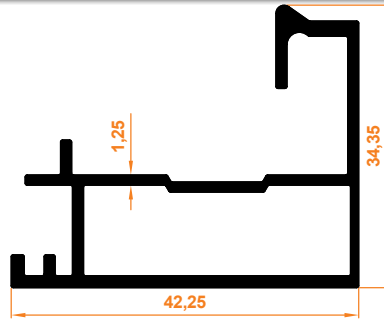

**Yan Kasa Profili**  
Side Case Profile

252

0,313 kg/m

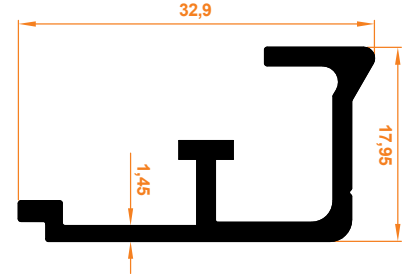

**Yan Kasa Kapak Profili**  
Side Case Cover Profile

7150

1,776 kg/m

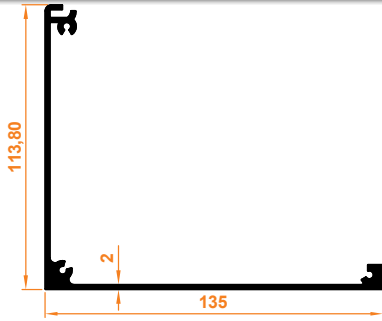

**Üst Kasa Profili**  
Upper Case Profile

7151

1,475 kg/m

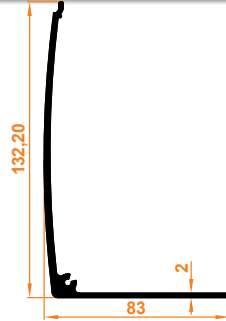

**Üst Kasa Kapak Profili**  
Upper Case Cover Profile

ZP 13

2,110 kg/m

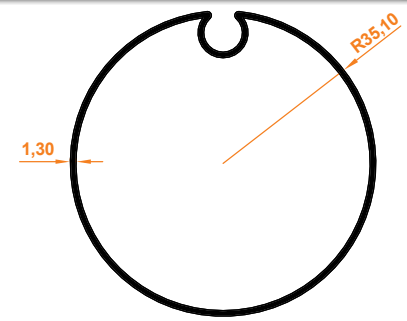

**Sac Tambur Borusu**  
Sheet Drum Tube

ZP 15

0,800 kg/m



**5x20 Lama Demir**  
5x20 Blade Iron

312

0,156 kg/m

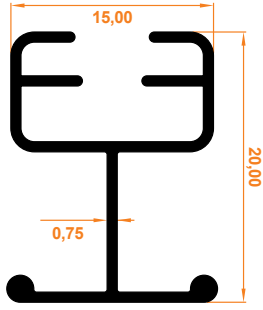

T Profil  
T Profile

334

0,265 kg/m

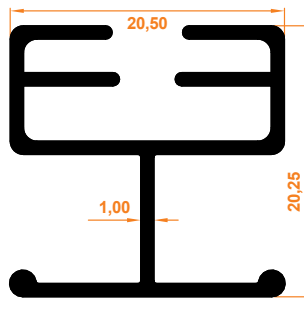

20'lik T Profil  
20 T Profile

339

0,102 kg/m

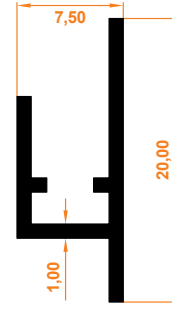

Yaylı Yapışkan Profil  
Spring Adhesive Profile

332

0,094 kg/m

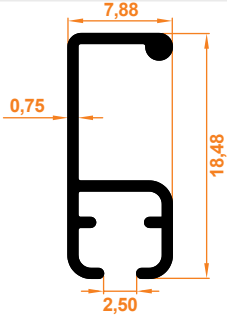

Small T Profil  
Small T Profile

340

0,076 kg/m

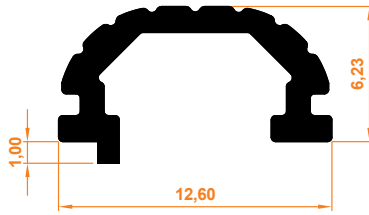

Yaylı Portray Profil  
Spring Portray Profile

327

0,252 kg/m

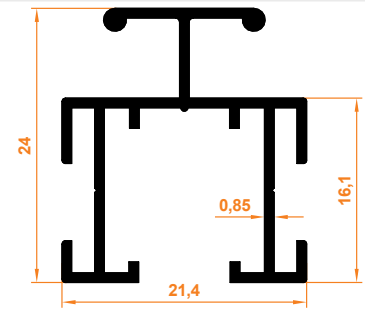

Çiftli Orta Profil  
Double Middle Profile

Process Alüminyum Plastik San. Tic. Ltd. Şti.

**MERKEZ**

Aşağıpınarbaşı OSB Mah. 524 Nolu Sk. No: 3/1 42250,  
Selçuklu-Konya/TÜRKİYE

**T** : +90 332 248 00 92

**F** : +90 332 248 00 93

**M** : info@process.com.tr

**MARMARA BÖLGE MÜDÜRLÜĞÜ**

Cihangir Mh. Talatpaşa Cad. No:67  
Avcılar/İSTANBUL - TÜRKİYE

**T** : +90 212 407 17 42

**F** : +90 212 407 15 42

**M** : marmara@process.com.tr

|| [www.process.com.tr](http://www.process.com.tr)

|| [www.processplise.com.tr](http://www.processplise.com.tr)

|| [www.panjurmen.com.tr](http://www.panjurmen.com.tr)

|| [www.demarco.com.tr](http://www.demarco.com.tr)

|| [www.prosin.com.tr](http://www.prosin.com.tr)

